

Owner's Manual

Instruction Book for:

MODEL 887™ NITROMAG™
PUMP ACTION SHOTGUN

Remington®

MODEL 887™ NitroMag™
Pump Action Shotgun

Remington®

Remington is a Trademark Registered in the United States Patent and Trademark Office By
Remington Arms Company, Inc.

Part No. 302011
10/09
ORIG

Printed in the U.S.A.

IMPORTANT!

READ ALL INSTRUCTIONS
AND WARNINGS IN THIS
BOOK BEFORE USING THE FIREARM



Page 2The Ten Commandments of Firearm Safety
Page 7Important Parts of the Firearm
Page 10How to Load
Page 11How to Unload
Page 13Lubrication and Maintenance
Page 22How to Obtain Parts and Service

A Tradition of Performance and Safety.

In 1816 Eliphalet Remington was confident he could make a flintlock that was as good or better than any he could buy. His confidence was well founded. The barrel he handcrafted set a new standard for firearm accuracy and spawned generations of products that have made Remington® Arms America's leading gunmaker. While performance and style are certainly hallmarks of Remington firearms, one factor ultimately drives their performance. Safety. Eliphalet Remington never lost sight of the fact that his rifles were potentially lethal and could kill someone if handled improperly. And after more than 180 years the same holds true for any firearm, including your new Remington. Eliphalet Remington's first flintlock launched a proud tradition of accuracy and responsibility.



Eliphalet Remington's first flintlock launched a proud tradition of accuracy & responsibility

Safety is Critical to Performance.

A superbly crafted gun is only as good as the hands that hold it. You can never be too careful. Shooting accidents are often caused by careless oversights such as failing to control the direction of the muzzle, failing to fully engage the safety, leaving ammunition in the chamber or using improper loads. These oversights can result in the destruction of life, limb or property. There's no calling back a bullet once it's been fired, so it's critical that you know the principles of safe gun handling and storage before you ever take your new Remington firearm out of the box.

The proper use and performance of your firearm depends on correct assembly and maintenance, so it's critical that you familiarize yourself with the information in this instruction book. Even if you're a veteran shooter with a collection of Remington firearms, take the time to read this literature. Not all firearms are the same. That means the first step in safe handling is to learn the features and requirements of your new Remington.

THE TEN COMMANDMENTS OF FIREARM SAFETY

The Ten Commandments of Firearm Safety should be etched in your memory forever. Let them govern your action wherever and whenever you're involved with firearms. In the field. On the range. Or in your home. Please take the time to review and understand these rules.

1st COMMANDMENT

ALWAYS KEEP THE MUZZLE POINTED IN A SAFE DIRECTION.

This is the most important gun safety rule. A safe direction is one in which an accidental discharge will not cause injury to yourself or others. Never allow your gun to point at anything you don't intend to shoot. Be especially careful when you're loading or unloading. Treat every gun as if it were loaded. And make it a habit to know where the muzzle is pointed at all times, even when your firearm is un-loaded. No one will be injured by an accidental discharge if you keep your firearm pointed in a safe direction. It's as simple as that.



2nd COMMANDMENT

Firearms should be Unloaded When Not Actually in Use.

Load your firearm only when you're in the field or on the target range and ready to fire. Never let a loaded gun out of your sight or out of your hands. Unload it as soon as you're finished shooting - before you bring it into your car, camp or home. Remember, unloading your firearm means unloading it completely, so there is no ammunition in the chamber or in the magazine. Before handling a firearm or passing it to someone else, visually check the chamber, receiver and magazine to be certain they do not contain ammunition. Always keep the gun's action open when not in use. Never assume a gun is unloaded even if you were the last person to use it. Always check for yourself.

• *Let common sense rule* when you carry a loaded gun. If you're in a situation that could risk accidental discharge - such as crossing a fence, wading through a stream or climbing a tree - always unload your gun. Never pull or push a loaded firearm toward yourself or another person. And never carry a loaded gun in a scabbard, detached holster or gun case.

• *Certain firearms* (including some Remington® rifles and shotguns) are equipped with internal security devices to prevent unauthorized use. In addition, some firearms owners use external devices, such as cable locks and trigger blocks, for the same purpose. Even if you use such a device, you should still keep your firearm unloaded when stored or not in use. And using internal or external devices cannot substitute, however, for securing your firearms and ammunition in a separate, locked location.

• *Safe storage* of firearms is just as critical as safe handling. Never store guns loaded. Be sure to keep your firearms in a secure place where unauthorized persons cannot get their hands on them without your knowledge.

• *Take special care* if there are children around. Children are fascinated by guns. It's a natural curiosity that can have tragic consequences when not properly supervised. Store your firearms in a locked gun safe or some other location that physically bars a child from gaining access.

• *Ammunition* should be stored and locked in a location separate from your firearm. Never leave an unsecured firearm or ammunition in a closet, dresser drawer or under the bed. Remember, it is your responsibility to make sure that children and others unfamiliar with firearms cannot get access to your firearm and ammunition.



Firearms should be stored in a secure place where children cannot access them. A gun safe is an ideal way to secure your firearm



3rd COMMANDMENT

DON'T RELY ON YOUR GUN'S SAFETY

Treat every gun as if it can fire at any time, whether or not there's pressure on the trigger. Your firearm has been carefully designed to maximize performance and safety. However, because a gun's safety is a mechanical device, it could fail.

Human error is a more likely reason for a gun safety to fail. By mistake, you may think the safety is on when it really isn't. Or the safety may have been disengaged without your knowledge. Or you could think your gun is unloaded when there's actually a cartridge or shell in it. A mechanical safety is not a substitute for common sense. It's merely a supplement to your proper handling of a firearm.

Never touch the trigger on a firearm until you are ready to shoot. Keep your fingers away from the trigger when you're loading or unloading. And don't pull the trigger when the safety is engaged or positioned between safe and fire.

Before using your gun, read this instruction book to understand the exact location and operation of your firearm's safety. Even when the safety is on, maintain control of your loaded firearm and control the direction of the muzzle. In other words, don't rely on your safety to justify careless handling. If your firearm's internal mechanisms are broken or have been altered, your firearm may fire even when the safety is on. Remember, you and your safe gun handling practices are your gun's best safety.



4th COMMANDMENT

BE SURE OF YOUR TARGET AND WHAT'S BEYOND IT.



You can't stop a shot in mid-air, so never fire unless you know exactly where your shot is going and what it will strike. Never fire at a sound, a movement or a patch of color. A hunter in camouflage can easily be mistaken for a target by an impulsive shooter. Before you pull the trigger be absolutely sure of your target and what's behind it. Make sure the shot has a backstop such as a hillside or dense material like sand. Remember, bullets can travel great distances with tremendous velocity. Know how far your shot will go if you miss your target or the bullet ricochets.

5th C O M M A N D M E N T

Use Proper Ammunition

Every firearm is designed to use a certain caliber or gauge of ammunition. Using the wrong ammunition, mixing ammunition or using improperly reloaded ammunition can cause serious personal injury or death. And it only takes one cartridge or shotshell of the incorrect caliber or gauge, or which has been improperly reloaded, to destroy your firearm. It's your responsibility to make sure the ammunition you use exactly matches the caliber or gauge of your gun. Refer to this instruction book to find out the specific requirements of your firearm. Always read and heed the instructions on ammunition boxes.

Confusing shells or cartridges can cause serious personal injury or death and destroy your firearm. Examine your shells or cartridges closely and use only the precise caliber or gauge for your specific firearm. For example, suppose you accidentally loaded a 20 ga. shell into a 12 ga. shotgun. Because the 20 ga. shell is too small for the chamber, the 20 ga. shell could travel down the barrel and get lodged in the bore. If you then loaded a standard 12 ga. shell behind it and fired, the 12 ga. shot will slam into the lodged 20 ga. shell and may cause the barrel to explode right in your hand. This is commonly called a 12/20 burst, and it can kill you.

Check all ammunition before you load it to make sure it matches your gun's requirements. Every Remington® cartridge and shell is head-stamped with its caliber or gauge for easy identification. Likewise, you'll find the caliber or gauge of your new Remington firearm imprinted on the barrel.

Reloading Requires Extra Diligence.

If you're an ammunition reloader, you are responsible for personally assuring that the loads and components of your reloaded ammunition meet your gun's factory-tested standards. Never use ammunition, which has been reloaded by someone else!

Many shooters handload as a hobby or to save money on commercial, factory-made ammunition. However, it requires a thorough knowledge of reloading procedures and a deep respect for the explosive potential of gunpowder.

Firearms are designed, manufactured and proof-tested to standards based on factory-loaded ammunition. Handloaded or reloaded ammunition that deviates, either intentionally or accidentally, from load or component recommendations can be very dangerous.

Reloaders must observe all possible safety precautions and practices related to the proper handling of explosives. Whether you're a seasoned reloader or just starting out, you should study the subject, watch reloading demonstrations and talk to experienced reloaders.

The first rule of reloading is to always follow the manufacturer's instructions for the components you're using. They'll tell you to follow certain guidelines. Namely:

1. Don't mix or substitute powders or primers.
2. Don't use unknown or substandard components.
3. Use only suitable components that have been factory-tested by reputable ammunition, powder and bullet manufacturers.
4. Always be sure to use the manufacturer's recommended recipe when reloading.

Not following these guidelines could result in severe injury to yourself or severe damage to your firearm. Dangerously high pressure and explosions can result from an overcharge of powder or other deviations from established reloading guidelines. Be very careful. The process of reloading exposes you to environmentally hazardous material. Lead, which is known to cause cancer and birth defects, is the most common substance in bullets and shot. It is important to handle lead bullets and shot with extreme care. Work only in a well-ventilated area and always wash your hands after exposure and before eating. Never smoke while reloading.

Primers and powders are also highly toxic and flammable. So after reloading be sure to clean up all materials from your work area. Don't leave primer or powder spills anywhere on the floor or bench top. Dispose of all waste material in accordance with the manufacturer's recommendations.

Finally, when reloading or handloading concentrate on what you're doing at all times. Do not be distracted by talking to others, listening to the radio or watching TV while reloading. Never reload after consuming alcoholic beverages or drugs of any kind. You are working with extremely hazardous materials and you can't risk even a few seconds of distraction. Remember, if you reload, you are the ammunition manufacturer and you are responsible for the performance and safety of your reloaded ammunition.

6th C O M M A N D M E N T

IF YOUR GUN FAILS TO FIRE WHEN THE TRIGGER IS PULLED, HANDLE WITH CARE.

If for some reason the ammunition doesn't fire when you pull the trigger, stop and remember the 1st Commandment of Firearm Safety - always keep the muzzle pointed in a safe direction. Keep your face away from the breech, then put the safety on, carefully open the action, unload the firearm and dispose of the cartridge safely. Remember that anytime there's a shell in the chamber, your gun is loaded and ready to use. Even if you tried to shoot and your gun didn't fire, treat your firearm as if it could still discharge.

7th C O M M A N D M E N T

ALWAYS WEAR EYE AND EAR PROTECTION WHEN SHOOTING.

Your sight and hearing risk injury from shooting and should be protected at all times. Wear protective shooting glasses to guard against falling shot, clay target chips, powder residue, ruptured cartridge cases and even twigs and branches in the field. Also be sure to wear eye protection when you're disassembling or cleaning a gun so that tensioned parts (like springs) and cleaning solvents don't come in contact with your eyes. Continued exposure to shooting noise can permanently damage your hearing. On the range, where shooting volume is the loudest, be sure to use the maximum protection of a headset. And learn to use ear protection in the field, especially in confined locations like duck blinds.



8th C O M M A N D M E N T

BE SURE THE BARREL IS CLEAR OF OBSTRUCTIONS BEFORE SHOOTING.

Before loading your gun, open the action and make sure there's no ammunition in the chamber or magazine. Check the barrel for any obstructions or debris. Even a small amount of snow, mud, excess lubricant or grease in the bore can dangerously increase pressure and cause the barrel to bulge or burst when firing. Use a cleaning rod and patch to wipe away anti-rust compounds or any other residues or obstructions in the barrel. Never try to shoot out an obstruction by loading another shell and firing!

When firing, rely on your instincts. If the noise or recoil of your firearm seems weak, stop everything, unload your firearm and be sure nothing is lodged in the barrel. Remember the 12/20 burst? That's what can happen when the barrel is obstructed. So always be sure you're using the correct ammunition in your firearm and that it's free of obstructions.

9th C O M M A N D M E N T

DON'T ALTER OR MODIFY YOUR GUN AND HAVE IT SERVICED REGULARLY.

Your firearm has been designed to operate according to certain factory specifications. You'll jeopardize your safety and that of others around you by attempting to alter its trigger, mechanical safety or other mechanisms. So never alter or modify your firearm in any way.



Like any mechanical device, a firearm is subject to wear. It must be maintained and periodically serviced to assure optimum safety and performance. Only a qualified service facility should service, repair or modify your Remington® firearm. Consult your instruction book for instructions on how to send your firearm to the factory or for the location of the nearest Remington repair station.

Proper cleaning and lubrication are also important to firearm maintenance and are necessary to assure accuracy, safety and reliability. Before cleaning, always make sure that your gun is completely unloaded. And always clean the barrel from the chamber end to the muzzle when possible.

Make it a practice to clean your bore every time you're going to shoot. Be sure to clean your entire gun before and after long-term storage and no less than once a year. It's also important to clean your gun whenever it's been exposed to adverse conditions such as rain, dirt, mud, snow, sleet or saltwater.

For safe and dependable operation of your firearm, all parts of your gun must be properly cleaned and lubricated. Periodically inspect the internal workings of your firearm to be sure they're clean and free of rust, unwanted dirt and debris.

Use recommended lubricants on your gun and do not over-lubricate. The use of a non-recommended lubricant could adversely affect the function and safe operation of your firearm. Remember, you are responsible for the proper care and maintenance of your firearm. Failure to properly maintain your firearm cannot only damage or ruin your firearm, it can expose you and others to unnecessary risks of personal injury or death.

Remington® has a wide range of firearm care products and resources for best results when cleaning your gun. Everything from solvents and lubricants to rods and patches. They're all available from your Remington dealer.

10th COMMANDMENT

LEARN THE MECHANICS AND HANDLING CHARACTERISTICS OF YOUR FIREARM.

Not all guns are alike. They have different mechanical characteristics that dictate how you should carry and handle them. Anyone who plans to use a firearm should first become totally familiar with the type of firearm it is and the safe handling procedures for loading, unloading, carrying, shooting and storing it.

Before you even unpack your new Remington firearm, read this instruction book from cover to cover and familiarize yourself with the different component parts of the gun. Then read, understand and follow the Ten Commandments of Firearm Safety in this book.

WARNING! Discharging firearms in poorly ventilated areas, cleaning firearms or handling ammunition may result in exposure to lead, a substance known to cause birth defects, reproductive harm, cancer and other serious physical injury. Have adequate ventilation at all times. Wash hands thoroughly after exposure.

SHOOT SOBER!!

There's one other rule that must be followed when handling firearms. In fact, respect for this rule is necessary in order to effectively practice the Ten Commandments of Firearm Safety. The rule is: SHOOT SOBER! Guns and alcohol or drugs make a deadly combination. Never consume anything that would mildly impair your judgment or physical coordination when you're using a firearm. A staggering percentage of the shooting accidents that occur every year involve alcohol or drugs. Be smart. Always shoot sober and stay alive.

WARNING! Failure to follow any of these safety rules may cause personal injury or death to the shooter or bystander and damage to property. Do not use a firearm until you fully understand and practice the Ten Commandments of Firearm Safety. If you have any questions about the safe use of a Remington firearm, write to us at Remington Arms Company, Inc., Consumer Service, P.O. Box 700, Madison, NC 27025-0700, or call us at 1-800-243-9700.

DON'T KEEP THIS TO YOURSELF.

Now that you're a gun owner you have the obligation to help ensure that shooting sports are safe for everyone - participants and bystanders alike. You can do that by practicing these principles of firearm safety and passing them on to others - especially new shooters. Set an example for beginners. Be a guide to their safe entry into the exciting world of shooting sports. Invest your time and patience for the love of the sport and for its future. After all, it's your love of the sport that led you to buy a new Remington.

Firearm ownership is a right and privilege. It's a right guaranteed in this nation's Constitution. It's a privilege, which carries with it a personal responsibility to use your firearm in a way which will ensure your safety and the safety of others. The preservation of this right and privilege depends on the personal commitment of you and your fellow shooters to the safe and responsible use of firearms. Let the Ten Commandments of Firearm Safety outlined in the book guide you at all times. Teach and promote these rules whenever you can. Remember, firearm safety depends on you! That's the only way to really enjoy your new Remington firearm and to preserve sport shooting as we know it today.



Remington® Model 887™ NitroMag™ Pump Action Shotgun

Congratulations on your choice of a Remington®. With proper care, it should give you many years of dependable use and enjoyment. For best results, we recommend that you use Remington Ammunition - the ammunition used in factory testing your firearm against our rigorous function and performance standards.

PICTURE 1 This picture shows the main parts of a REMINGTON® MODEL 887™ NitroMag™ Pump Action Shotgun. The picture will aid in understanding the instructions.

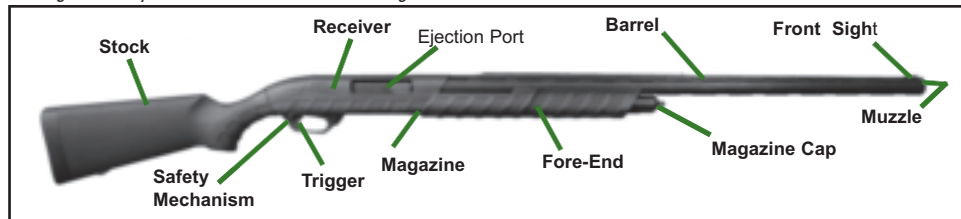

GENERAL OPERATION

The Remington Model 887™ NitroMag™ is a pump operated shotgun, incorporating a steel barrel and receiver over molded with high strength polymer. It is capable of firing multiple shots with each cycle of the action and pull of the trigger. At the start of the firing cycle after a chambered shell is discharged the bolt unlocks. As the fore-end or action is opened, the spent shell is pulled from the chamber and expelled out of the receiver through the ejection port. As the fore-end continues rearward the hammer is cocked and the trigger is reset. When the fore-end is in the full rear position, a shell is released from the magazine onto the carrier. As the fore-end is moved forward the carrier rises and places the new shell in front of the bolt. When the fore-end is moved fully forward, the new shot shell is chambered by the bolt and the bolt locks into position, completing the cycle.

SERIAL NUMBER, SHOTSHELL GAUGE AND LENGTH

The serial number is located on the bottom of the receiver. See Picture 2.

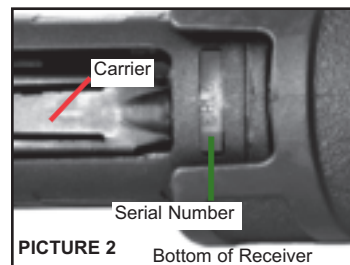

Specifications for the gauge and length of the shotshells intended for use in your shotgun are located on the shooter's left side of the barrel.

WARNING! Only use the specified gauge and length shotshell ammunition specified for your shotgun as designated on the barrel. See "To Load Your Firearm".

IMPORTANT PARTS OF THE FIREARM

The Safety Mechanism

The safety mechanism of the Model 887™ NitroMag™ shotgun provides protection against accidental or unintentional discharge under normal usage when properly engaged and in good working order.

The safety mechanism is not a substitute for following the rules of safe gun handling. The cross-bolt type safety prevents the trigger from being pulled when engaged in the "ON" or "SAFE" position.

To engage the safety mechanism for right-handed guns, push the "safety button" located at the rear of the trigger guard to the shooter's right until the button stops and the **RED BAND MARKING CANNOT BE SEEN**. See Picture 3.



Always engage the safety mechanism by moving the safety button to the shooter's right before handling, loading or unloading the firearm.

When you are ready to FIRE the firearm, disengage the Safety Mechanism by pushing the Safety Button to the shooter's left until the button stops and the **RED BAND MARKING IS VISIBLE**. See Picture 4. You have now disengaged the Safety Mechanism and the shotgun is ready to FIRE.

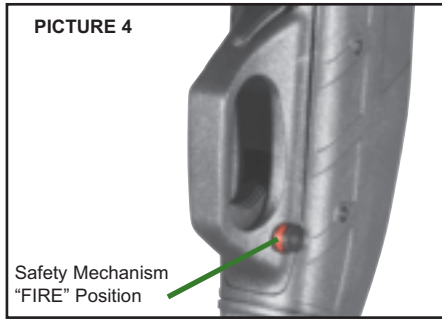

Do not touch the trigger while moving the safety button. Your fingers and all other objects should be kept outside of the trigger guard and away from the trigger until you are actually ready to FIRE.

Never pull the trigger when the Safety Mechanism is in the "ON" or "SAFE" position.

WARNING! The firearm will fire when the trigger is pulled and the safety mechanism is in the "OFF" or "FIRE" position.

Even when the safety is engaged in the "ON" or "SAFE" position, careless handling can cause the firearm to discharge. See the Ten Commandments of Firearm Safety on page 2.

The Locking Device

This firearm was originally sold with a key-operated locking device to assist the owner in protecting against unauthorized use. These are storage locking devices and the firearm should be completely unloaded when stored or not in use. Using a locking device cannot substitute for

securing your firearm and ammunition in separate locked locations. See the Ten Commandments of Firearm Safety.

THE LOCKING DEVICE DOES NOT ELIMINATE THE NEED FOR SAFE GUN HANDLING AND STORAGE, INCLUDING KEEPING THIS AND EVERY GUN UNLOADED AND LOCKED IN A SECURE PLACE WHEN NOT IN USE. READ AND FOLLOW THESE AND OTHER SAFETY RULES IN THIS INSTRUCTION BOOK. FAILURE TO READ, UNDERSTAND AND OBEY THESE RULES CAN RESULT IN SERIOUS PERSONAL INJURY OR DEATH. SEE THE TEN COMMANDMENTS OF FIREARM SAFETY ON PAGE 2.

Keep your locking device engaged when your firearm is not in use. Keep the keys in a secure place, inaccessible to others. DO NOT leave your keys or any ammunition with your firearm, which should be kept unloaded and locked in a safe place.

The Fore-end and Bolt Release

The action will open when the fore-end is moved rearward. The bolt release is used to unlock the bolt. The action can be opened when the bolt release is activated by pushing inward while moving the fore-end rearward. See Picture 5.

WARNING! When the fore-end or action is forward in the closed position and the safety mechanism is in the "OFF" or "FIRE" position, the shotgun can be discharged by pulling the trigger.

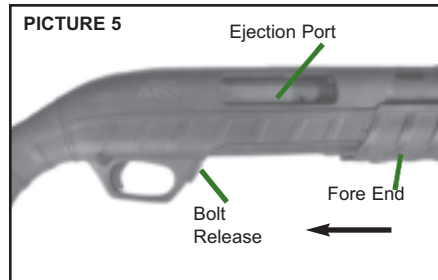

The Trigger Assembly

Pulling the trigger DISCHARGES the firearm.

The trigger assembly of the Model 887™ NitroMag™ shotgun has been set at the Remington factory for optimal trigger pull. The factory settings provide a crisp, clean

trigger pull for superior performance. The trigger assembly is not adjustable. All repairs to the trigger assembly must be made by the factory or a REMINGTON® AUTHORIZED REPAIR CENTER.

WARNING! Never place your finger on the trigger unless you are ready to discharge the firearm.

The Barrel

WARNING! The inside of the barrel must be clean and free of obstructions. See the Ten Commandments of Firearm Safety on page 2.

To check the Barrel for obstructions:

1. Point the shotgun in a safe direction.
2. Engage the safety mechanism by placing the safety mechanism in the "ON" or "SAFE" position. The Red Band Will **NOT** Be Visible.
3. While pressing the bolt release, open the bolt by pulling the fore-end rearward.

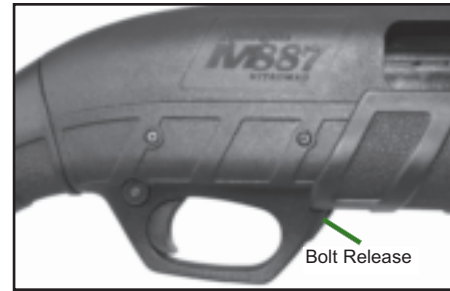

4. Look into the ejection port, visually check the chamber, carrier, and magazine to make sure the shotgun is completely unloaded.
5. Insert a cleaning rod into the muzzle.
6. Push the rod completely through the barrel until the rod can be seen at the ejection port.

To remove object from inside the Barrel:

WARNING! NEVER try to remove an object from the barrel by loading another shotshell and firing. This may cause the barrel to burst or a shotshell to rupture and cause serious personal injury or death.

1. Point the shotgun in a safe direction.
2. Engage the safety by placing the safety

- mechanism in the "ON" or "SAFE" position. The Red Band Will **NOT** Be Visible.
3. Press the bolt release and open the bolt by pulling the fore-end rearward.
4. Look into the ejection port, visually check the chamber, carrier, and magazine to make sure the shotgun is completely unloaded.
5. To remove the barrel, See: "To Disassemble The Firearm for Cleaning", on Page 13.
6. Insert cleaning rod into the muzzle and lightly tap rod to free object from the barrel.
7. Push rod all the way through the barrel until the rod can be seen at the chamber opening.
8. If an object cannot be easily pushed out of the barrel with a cleaning rod, return the firearm to the factory or a REMINGTON® AUTHORIZED REPAIR CENTER.

How To Assemble:

The Model 887™ NitroMag™ was shipped with the barrel assembly removed. See Picture 6.

Note: The bore and chamber must be cleaned before assembly. See "Cleaning, Lubrication, and Maintenance", on Page 13.

1. Engage the safety by placing the safety mechanism in the "ON" or "SAFE" position. The Red Band Will **NOT** Be Visible.
2. Visually check the inside of barrel making sure there are no obstructions.
3. Unscrew and remove the magazine cap by turning it counter clockwise.
4. Slide the cardboard packing ring forward and remove from the magazine tube.

WARNING! DO Not pump the action or pull the trigger repeatedly with the barrel removed.

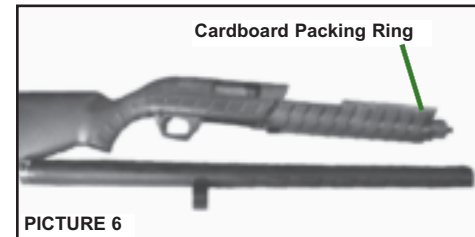

PICTURE 6

5. Press the Bolt Release while moving the fore-end approximately halfway rearward. See Picture 5.
6. Insert the barrel into the receiver and the

barrel ring over the magazine tube. See Picture 7.

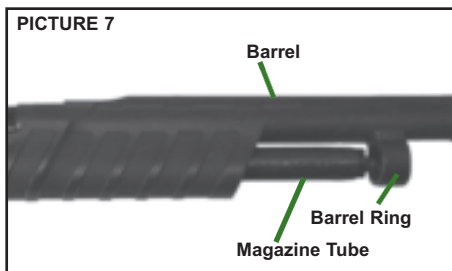

- Once the barrel is fully inserted into the receiver, replace the magazine cap on top of the magazine tube. Tighten by turning clockwise until hand-tight.
- Point the firearm in a safe direction.
- Open the bolt by pressing the bolt release while moving the fore-end fully rearward.

TO LOAD THE FIREARM:

WARNING! The specific gauge and length of shotshell ammunition suitable for use in your shotgun is marked on the barrel. Different gauges and shell lengths are not interchangeable. Do not use any ammunition other than the designated gauge and length specified for your shotgun. USING INCORRECT AMMUNITION IN YOUR FIREARM CAN RESULT IN A SEVERE MALFUNCTION OF YOUR FIREARM OR AMMUNITION LEADING TO PERSONAL INJURY OR DEATH. See the Ten Commandments of Firearm Safety on page 2.

Ammunition:

Always check the shotshell for the correct gauge and length before loading the firearm. To find additional information on shotshells ammunition, see publication: The Remington Guide to Shotguns and Ammunition at www.remington.com.

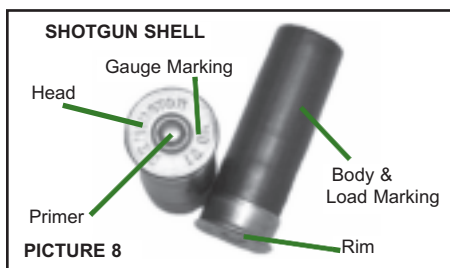

To load the Chamber and Magazine:

NOTE: The bore should be cleaned before

loading the firearm the first time. Follow cleaning instructions shown on Page 14, "To Clean Barrel".

- Point the shotgun in a safe direction.
- Engage the safety by placing the safety mechanism in the "ON" or "SAFE" position. The Red Band Will **NOT** Be Visible.
- While pressing the bolt release, open the action by pulling the fore-end rearward.
- Look into the ejection port, visually check the chamber, loading port, and magazine to make sure the shotgun is completely unloaded. Also make sure the barrel is free of obstructions.

To Load the Chamber:

- Put one shell of correct gauge and length through the ejection port.
- Move the fore-end forward, closing the action.

To Load the Magazine:

- Push up to four (4) shells, (three (3) 3-1/2") one at a time, fully forward into the magazine tube making sure the rim of each shell engages the feed latch and is held inside the magazine tube.

WARNING! The shotgun is now cocked and fully loaded. Make sure the safety mechanism is still engaged in the "ON" or "SAFE" position. The Red Band Marking Will **NOT** be Visible. Keep the shotgun pointed in a safe direction.

To Load The Chamber From The Magazine:

- Point the firearm in a safe direction.
- Engage the safety by placing the safety mechanism in the "ON" or "SAFE" position. The Red Band Will **NOT** Be Visible.
- With the bolt open, visually check the chamber, ejection port, carrier, and magazine making sure the shotgun is completely unloaded and the barrel is free of obstructions.
- Close action by moving the fore-end fully forward.
- Push up to four (4) shells, (three (3) 3-1/2") one at a time, fully forward into the magazine tube making sure the rim of each shell engages the feed latch and is held inside the magazine tube.
- Open the bolt by pressing the bolt release while moving the fore-end fully rearward.
- Place the shell in the chamber by closing the bolt and moving the fore-end fully

forward until the bolt locks into position. **WARNING!** The shotgun is now cocked and fully loaded.

TO DISCHARGE THE FIREARM:

- Point the muzzle at your intended target.
- Disengage the safety mechanism by moving the safety button to the "OFF" or "FIRE" position. The Red Band Will Be Visible.
- With the butt of the shotgun firmly mounted against your shoulder and target acquired, pull the trigger. The firearm will discharge each time the trigger is pulled and the action is cycled until the magazine and chamber are empty.
- Engage the safety mechanism by placing the safety button in the "ON" or "SAFE" position. The Red Band Will **NOT** Be Visible.
- Look into the ejection port, visually check the chamber, loading port, and magazine to make sure the shotgun is completely unloaded.

HOW TO UNLOAD THE FIREARM

To Unload By Using Pump Action:

WARNING! NEVER assume your shotgun is unloaded to justify careless handling. Always control the direction of the muzzle of your firearm, even if you think it is completely unloaded.

- Keep the shotgun pointed in a safe direction throughout the unloading process.
- Engage the safety by placing the safety mechanism in the "ON" or "SAFE" position. The Red Band Will **NOT** Be Visible.
- Open the bolt by pressing the bolt release while moving the fore-end slowly rearward until the shell clears the chamber.
- Lift the front of the shell outward and remove from ejection port.
- Continue to move the fore-end fully rearward until the next shell is released from the magazine onto the carrier.
- Tip the firearm sideways allowing the shell to drop from the ejection port.
- Close the action by moving the fore-end forward.
- Repeat opening and closing the action (steps 5 through 7) until all shells are removed from firearm.
- With the bolt open, visually check the chamber, carrier, and magazine making sure the shotgun is completely unloaded.

To Unload Magazine Manually:

- Keep the shotgun pointed in a safe direction throughout the unloading process.
- Engage the safety by placing the safety mechanism in the "ON" or "SAFE" position. The Red Band Will **NOT** Be Visible.
- With action closed, push the carrier up against the bolt carrier exposing the staged shell in the magazine. **WARNING!** Shells in Magazine are under spring compression. Wear eye protection to avoid possible serious personal injury.
- Push the left (feed) latch in toward the receiver wall until the stage shell is released from the magazine. See Picture 9.

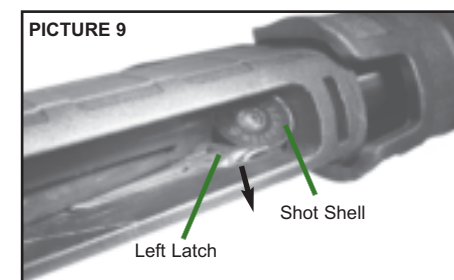

- Repeat step 4 until all shells are removed from magazine and the orange follower can be seen.
- Look into the ejection port and visually check the chamber, carrier, and magazine to make sure the firearm is completely unloaded and free of obstructions.

To Change the Choke Tube:

WARNING! COMPLETELY UNLOAD the firearm before changing the choke tube. (See Unloading Instructions).

- Point the shotgun in a safe direction.
- Engage the safety by placing the safety mechanism in the "ON" or "SAFE" position. The Red Band Will **NOT** Be Visible.
- Open the bolt by pressing the bolt release while moving the fore-end fully rearward.
- With the bolt open, look into the ejection port and visually check the chamber, carrier, and magazine to make sure the firearm is completely unloaded. Change the choke tube only when the bolt or action is open.

- Place the choke tube wrench supplied with your shotgun into the choke tube. See Picture 10.

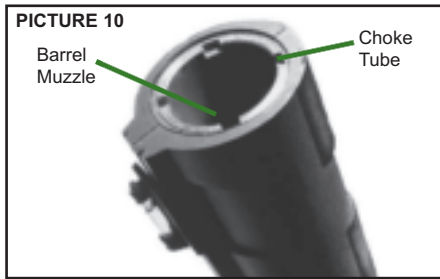

- Turn the choke tube wrench counterclockwise until the choke tube can be removed from the barrel.
- Select the desired choke tube and insert into the barrel muzzle.
- Place the choke tube wrench onto choke tube and tighten by turning clockwise. **Do Not Over Tighten!**
- With the Safety in the "ON" or "SAFE" position, bolt open, and the chamber and magazine completely unloaded, check the choke tube periodically to make sure it is tight and secure.

NOTE: NEVER discharge the shotgun without a choke tube installed.

To Install the Magazine Plug:

WARNING! A magazine plug limits the magazine capacity to two (2) shells. Such a plug and magazine capacity limit is required by the Federal Migratory Bird regulations and some certain state laws. Check with you local Fish & Game Commission or other appropriate authorities to determine whether a magazine plug is required in your jurisdiction.

- Point the shotgun in a safe direction.
- Engage the safety by placing the safety mechanism in the "ON" or "SAFE" position. The Red Band Marking Will **NOT** Be Visible.
- Completely unload the magazine and chamber. With the bolt open, look into the ejection port and visually check the chamber, carrier, and magazine to make sure the shotgun is completely unloaded. Also make sure the barrel is free of obstructions.
- Remove the magazine cap by turning counterclockwise.
- Place a large slotted screw driver into the magazine retainer. See Picture 11.

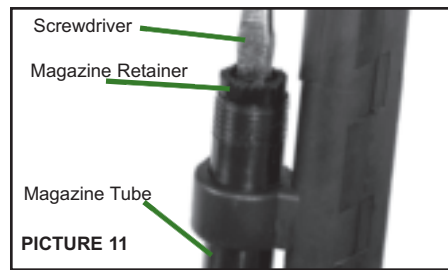

- Push down on the screw driver and retainer (approximately) one (1) inch or until you can turn the screw driver.

WARNING! Use extreme care when removing the magazine retainer, as the magazine spring is under compression. Always wear eye protection to avoid possible serious personal injury.

- Turn the screwdriver approximately 1/4 turn. Slowly release the magazine spring retainer as it is under pressure. Remove magazine retainer. Do not remove the magazine spring.
- Place the magazine plug, small end first, into the magazine spring. See Picture 12.

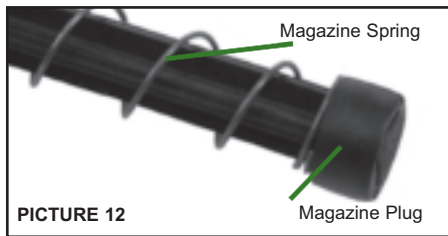

- Place the open end of the magazine spring retainer on top of magazine plug.
- While holding the magazine spring and retainer with one hand, place a slotted screw driver in the slot on top of the retainer.
- Push the magazine spring, plug, and retainer into the magazine tube while aligning the magazine spring retainer detent slots with the detents in the magazine tube. See Picture 13.

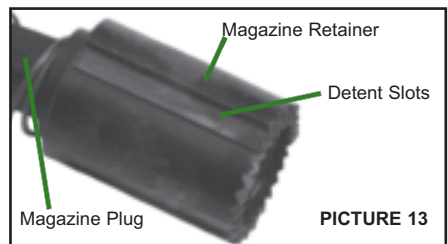

- Once the detents are aligned, push magazine spring, plug, and retainer down in the magazine tube (approximately 1 inch) until the screw driver can be turned 1/4 of a turn or until the detents are misaligned locking the retainer in position.
- Slowly remove the screw driver. When properly seated, the magazine spring retainer will be 1/4 inch higher than top of the magazine tube.
- Replace the magazine cap by turning clockwise until tight. **Do not over tighten.**

CLEANING, LUBRICATION AND MAINTENANCE

WARNING! Before cleaning, make sure your shotgun is completely unloaded (both the chamber and the magazine) and engage the safety mechanism in the "ON" or "SAFE" position.

WARNING! After each use, follow the lubrication and maintenance directions in this Manual. If the firearm is immersed in water, it must be thoroughly cleaned and lubricated as soon as possible. In case of saltwater immersion, first flush all parts with fresh water, then dry, clean and lubricate the firearm. If the firearm does not function properly, have it checked and corrected by a competent gunsmith before further use. Failure to follow these instructions may lead to firearm malfunctions which could result in serious personal injuries or death.

NOTE: The chamber and bore should be cleaned before loading and firing the firearm the first time.

Lubrication:

Over-lubrication should be avoided at all times. A light application of Rem™ Oil helps to prevent rusting. See note below.

WARNING! The use of a non-recommended lubricant could adversely affect the function and safe operation of your shotgun. Failure to properly maintain your shotgun can not only damage your firearm, it can expose you and others to unnecessary risks of personal injury or death.

When the firearm is to be stored, it should be carefully cleaned and thoroughly oiled. Outside metal surfaces

should be wiped with Rem™ Oil occasionally.

When the firearm is to be reused, all excess lubrication must be removed. The chamber and bore must be thoroughly wiped dry.

For safe and dependable operation of your shotgun, the barrel and action must be cleaned periodically.

NOTE: Remington Rem™ Oil is available from your local dealer. If your dealer is out of stock, ask him to order Rem™ Oil from his Remington Distributor.

To Disassemble The Firearm For Cleaning:

CAUTION: The Model 887™ NitroMag™ shotgun should not be disassembled beyond what is described in this manual, except by the factory or a REMINGTON® Authorized Repair Center.

WARNING! Unload the shotgun before cleaning. Look into the ejection port and visually check the chamber, loading port, and magazine to make sure there are no shells in the firearm. Always wear eye protection when disassembling and reassembling the firearm.

To Remove the Barrel:

- Point the firearm in a safe direction.
- Engage the safety by placing the safety mechanism in the "ON" or "SAFE" position. The Red Band Will **NOT** Be Visible.
- With the bolt open, look into the ejection port and visually check the chamber, carrier, and magazine to make sure the firearm is completely unloaded.
- Slide the fore-end forward approximately halfway.
- Remove the magazine cap by turning counterclockwise.
- Hold the barrel above the barrel ring and pull the barrel from the receiver. See Picture 14.

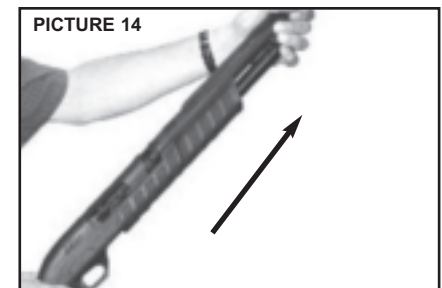

To Remove the Trigger Assembly:

1. Tap out the front and rear trigger assembly pins with a drive punch. See Picture 15.

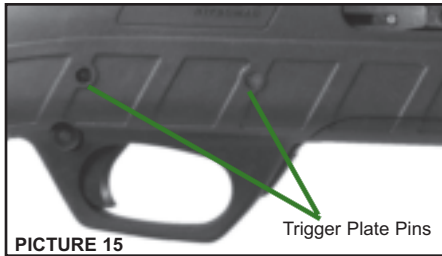

PICTURE 15

2. Remove the trigger assembly from the receiver by pulling downward. See Picture 16.

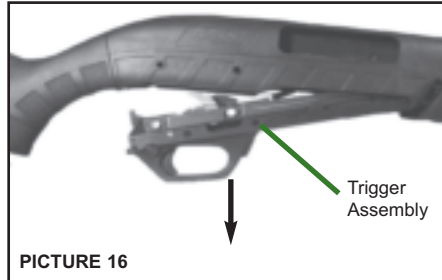

PICTURE 16

To Remove the Bolt Slide Assembly:

1. With the barrel and trigger assembly removed, move the fore-end forward until bolt assembly is free of receiver. See Picture 17.

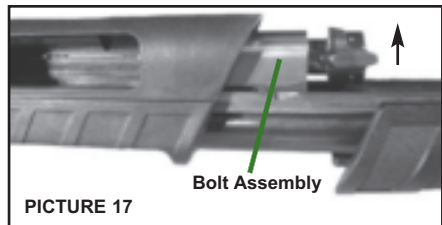

PICTURE 17

2. Remove bolt assembly from action bars by lifting bolt assembly upward.
3. Remove port cover from the bolt assembly by lifting port cover over the port cover guide pin then lift upward. See Picture 18.

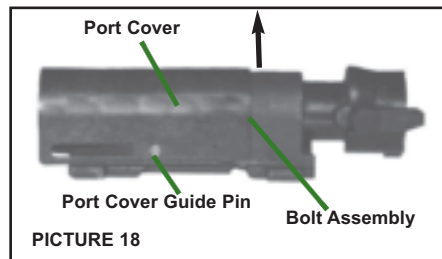

PICTURE 18

To Clean Barrel:

WARNING! The use of a non recommended lubricant or cleaner could adversely affect the function and safe operation of your shotgun.

1. Use the instructions and equipment provided in a quality cleaning kit such as a Remington® Cleaning Kit. For recommendations, see your dealer or a Remington® Authorized Gunsmith.
2. Saturate cleaning patch with Brite Bore™ or equivalent.
3. Attach the patch to a cleaning rod tip.
4. Pass the patch through bore from the chamber end to the muzzle several times removing loose residue and fouling.
5. Select the correct caliber cleaning brush and attach a brush to the cleaning rod.
6. Spray bore brush with Brite Bore.
7. Push the cleaning rod through the barrel several times.
8. Remove the brush from the rod and attach a tip with a cleaning patch.
9. Push the cleaning patch through the bore.
10. Repeat several times using a new cleaning patch each time until the patch is removed from the barrel without fouling residue.
11. Remove all shooting residue from the lock notch in barrel with Rem™ Action Cleaner. See Picture 19.

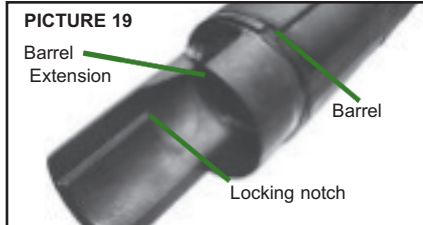

PICTURE 19

12. Push a clean patch saturated with Rem™ Oil through the barrel.
13. Push a clean dry patch through the barrel to remove excess lubricant.
14. Apply a light application of Rem™ Oil to the outside of the barrel extension with a soft clean cloth.

WARNING! After cleaning, make sure the barrel is free of obstructions.

To Clean the Choke Tube:

WARNING! The use of a non recommended lubricant or cleaner could adversely affect the function and safe operation of your shotgun.

1. Remove the choke tube from the barrel. See "To Change the Choke Tube", page 11.

2. Clean the choke tube, including the threads, with Rem™ Action Cleaner and wipe clean.
3. When dry, apply Rem™ Oil to the choke tube threads and reattach to barrel. See "To Change the Choke Tube", page 11.

To Clean the Bolt Assembly:

WARNING! The use of a non recommended lubricant or cleaner could adversely affect the function and safe operation of your shotgun.

1. Spray the bolt assembly and bolt head using Rem™ Action Cleaner and brush. See Picture 20.

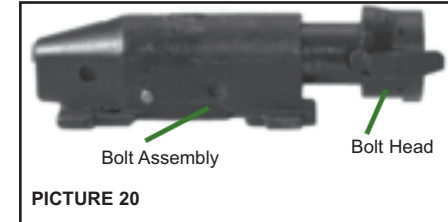

PICTURE 20

2. Wipe clean and let dry before applying a light application of Rem™ Oil to the bolt assembly and bolt head.

To Clean the Trigger Assembly:

WARNING: The use of a non-recommended lubricant could adversely affect the function and safe operation of your shotgun.

1. Thoroughly spray Rem™ Action Cleaner inside the trigger assembly where specified in Picture 21. Air dry or use compressed air to thoroughly dry the trigger assembly.
2. Apply a light application of Rem™ Oil to the areas specified in Picture 21.

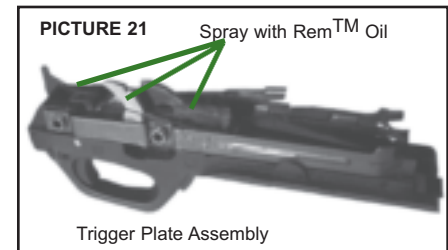

PICTURE 21

To Clean the Receiver Assembly:

WARNING! The use of a non recommended lubricant or cleaner could adversely affect the function and safe operation of your shotgun.

1. Thoroughly spray and brush all compo-

nents inside the receiver using Rem™ Action Cleaner.

2. Air dry or use compressed air to thoroughly dry the receiver assembly.
3. Spray the outside of the magazine tube with Rem™ Action Cleaner and wipe clean.
4. Wipe with a clean cloth and air dry or use compressed air to thoroughly dry the magazine tube.
5. Apply a light application of Rem™ Oil to the outside of the magazine tube and metal surfaces inside the receiver.

To Reassemble The Firearm:

WARNING! Visually check the chamber, ejection port, and magazine to make sure that the shotgun is completely unloaded and there are no shot shells anywhere in the shotgun.

1. With the port cover guide slot on the right side of the bolt assembly. Place the port cover over the port cover guide pin on the bolt assembly then snap the top of the port cover into place. See Picture 18.
2. Place Fore-end onto magazine tube with action bars bolt cuts in the up position as shown in Picture 22.

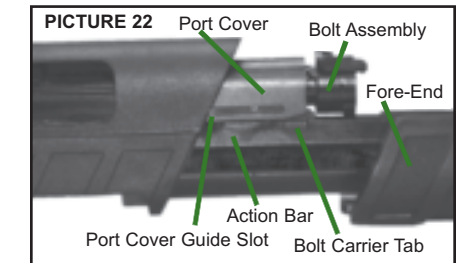

PICTURE 22

3. While holding the action bars with one hand, place the bolt assembly onto action bars with bolt head oriented toward the front of the receiver.
4. Align the action bars and bolt assembly with the right and left action rails in the receiver.
5. Move the fore-end rearward, sliding the bolt assembly halfway rearward.
6. Insert the barrel into the receiver and align the barrel ring over the magazine tube. See Picture 7.
7. Replace the magazine cap on top of the magazine. Secure by turning clockwise until hand tight. Do not over tighten.
8. Insert the trigger assembly by aligning the front notch into receiver. See Picture 23.

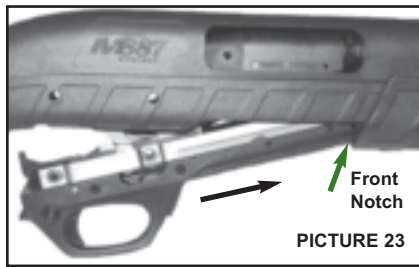

PICTURE 23

9. Align the trigger assembly with the mounting holes in the receiver by pressing bolt release while holding the Trigger Assemble in the receiver, move the fore-end fully rearward, then move fore-end fully forward.
10. Once the action is forward and the trigger assembly mounting holes are aligned with receiver, tap in the longer front trigger plate pin, then tap the shorter rear trigger assembly pin. See picture 24

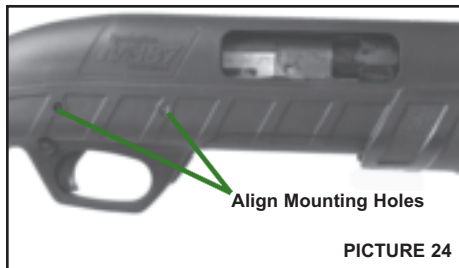

PICTURE 24

11. While pressing the bolt release, open the action by pulling the fore-end fully rearward.

To Function Test Firearm:

When the firearm is reassembled, a short function test should be conducted to ensure proper operation before loading or discharging the firearm. If firearm does not function as described in any of the Function Test then the firearm should be reassembled and function tested again. If the firearm fails the function test again, then the firearm should be sent to a REMINGTON® Authorized Repair Center or call: Remington's customer service number, 1-800-243-9700, Mon.-Fri., 9:00AM-5:00PM Eastern time.

WARNING! Completely unload the shotgun before Function Testing. Look into the ejection port and visually check the chamber, carrier, and magazine to make sure there are no

shells in the firearm. Always wear eye protection when handling the firearm.

1. Point the shotgun in a safe direction.
2. Engage the safety by placing the safety mechanism in the "ON" or "SAFE" position. The Red Band Will **NOT** Be Visible.
3. Press the bolt release and open the bolt by pulling the fore-end rearward.
4. Look into the ejection port, visually check the chamber, carrier, and magazine to make sure the shotgun is completely unloaded.
5. Close the action by moving the fore-end fully forward.
6. Without activating the bolt release, try to pull the fore-end rearward. The action should be locked into position and should not open.
7. Press the bolt release and open the bolt by pulling the fore-end rearward. The action should open without binding.
8. Close the action by moving the fore-end fully forward. The action should move freely and lock into the closed position.
9. Engage the safety by placing the safety mechanism in the "ON" or "SAFE" position. The Red Band Will **NOT** Be Visible.
10. Try to pull the trigger. The trigger should not move and the hammer should not fall.
11. Disengage the safety by placing the safety mechanism in the "OFF" or "FIRE" position.
12. Pull the trigger. The hammer should fall and the bolt should unlock.
13. Engage the safety by placing the safety mechanism in the "ON" or "SAFE" position. The Red Band Will **NOT** Be Visible.
14. Move the fore-end rearward. The bolt should be unlocked and move freely rearward.

WARNING! This firearm was designed and manufactured to properly perform with the original parts. It is the user's responsibility to insure all replaced parts are correctly installed and that neither replacements nor original components are altered or changed. Your firearm has many components that must work and relate correctly to other components for safe and accurate operation. Incorrectly assembling the firearm or with modified parts can result in damage to your firearm, or personal injury or death to you or others. Remington recommends all component replacements be performed by a Remington® Authorized Repair Center. If a repair or component replacement was not completed by a Remington® Authorized Repair Center we recommend that you have your firearm checked by an Authorized Repair Center. See page 22, for a Remington® Authorized Repair Center nearest you.

THE GUN OWNER and USER MUST ACCEPT FULL RESPONSIBILITY FOR THE CORRECT REASSEMBLY AND FUNCTIONING OF THE FIREARM AFTER DISASSEMBLY OR REPLACEMENT OF PARTS.

MODEL 887™ NitroMag™

Pump Action Shotgun Exploded View

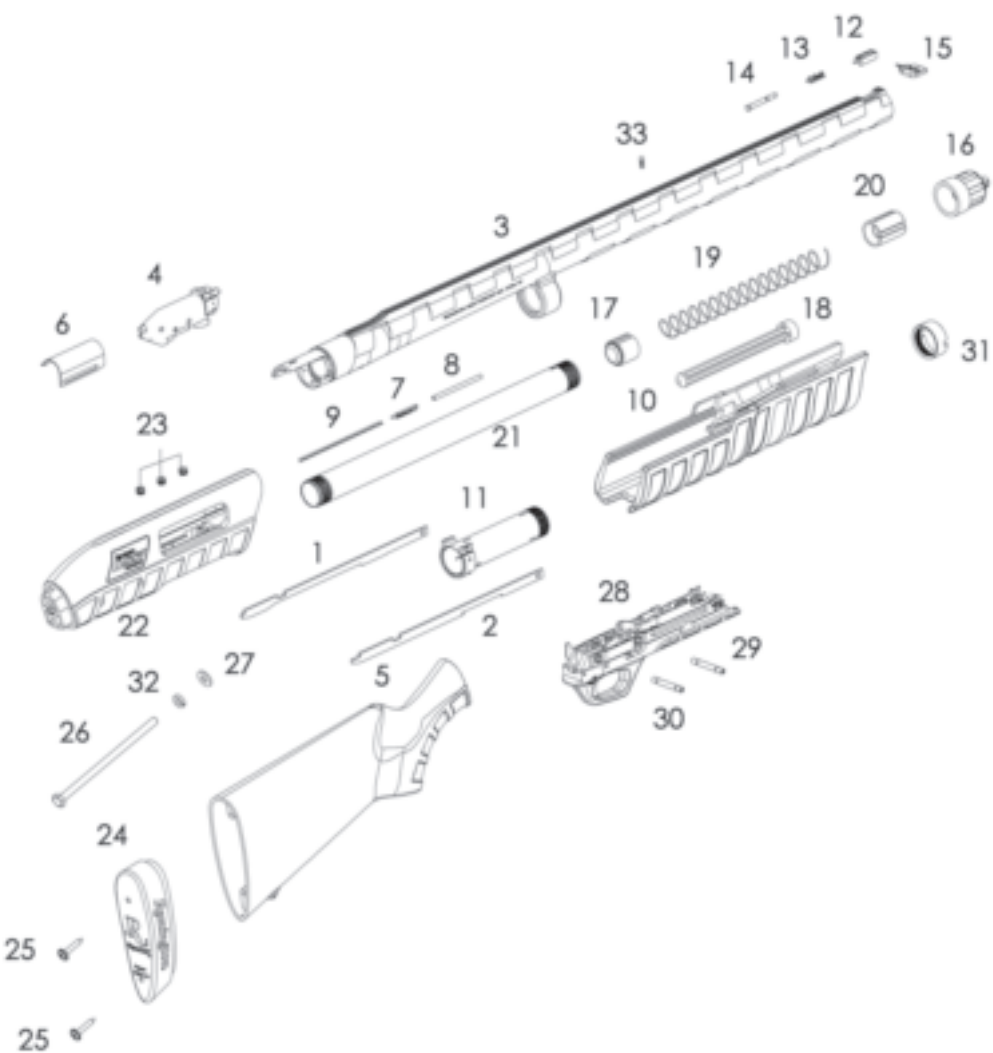

Schematic is provided for part identification only and should not be used as a guide to assemble the firearm.

MODEL 887™ NitroMag™

Pump Action Shotgun Parts List

Note: parts are subject to change without notice

ITEM NO.	PART NAME	ITEM NO.	PART NAME
1	Action Bar Left	18	Magazine Plug
2	Action Bar Right	19	Magazine Spring
3	Barrel	20	Magazine Spring Retainer
4	Bolt Assembly	21	Magazine Tube
5	Stock	22	Receiver
6	Ejection Port Cover	23	Receiver Plugs
7	Ejector	24	Recoil Pad
8	Ejector Retaining Pin	25	Recoil Pad Screw
9	Ejector Spring	26	Stock Attachment Bolt
10	Fore End	27	Stock Attachment Washer
11	Fore End Tube Assembly	28	Trigger Plate Assembly
12	Front Sight Base	29	Front Trigger Plate Pin
13	Front Sight	30	Rear Trigger Plate Pin
14	Lite Pipe	31	Tube Nut
15	Lite Pipe Key	32	Stock Lock Washer
16	Magazine Cap	33	Mid Bead
17	Follower		

MODEL 887™ NitroMag™

Pump Action Shotgun Exploded View

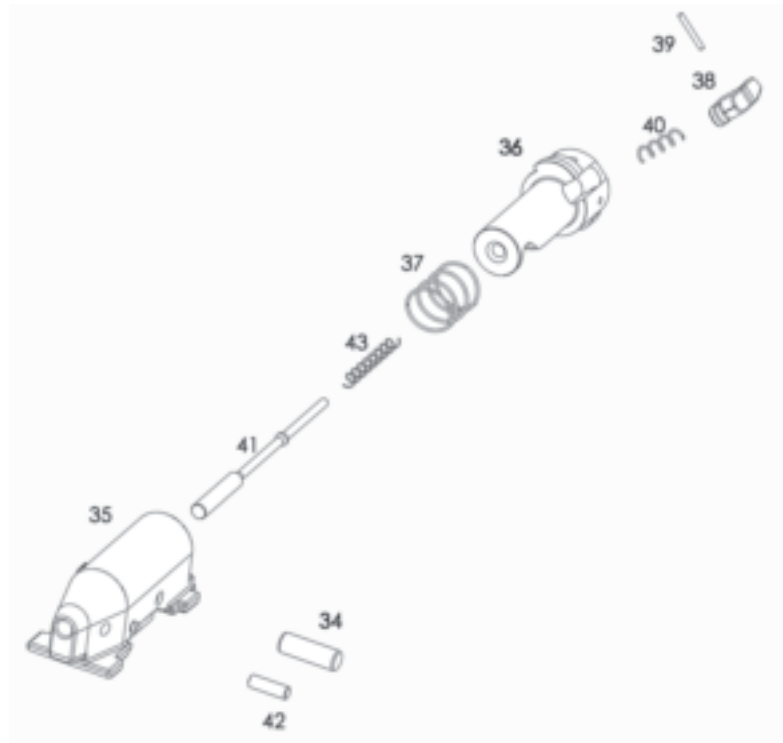

MODEL 887™ NitroMag™

Bolt and Trigger Plate Assembly Parts List

Bolt Assembly (4)

ITEM NO.	PART NAME
34	Bolt Cam Pin
35	Bolt Carrier
36	Bolt Head
37	Bolt Head Bias Spring
38	Extractor
39	Extractor Retaining Pin
40	Extractor Spring
41	Firing Pin
42	Firing Pin Retaining Pin
43	Firing Pin Spring

Trigger Plate Assembly (28)

ITEM NO.	PART NAME
44	Action Bar Lock
45	Action Bar Lock Release Button
46	Action Bar Lock Release
47	Action bar Lock Spring
48	Carrier
49	Carrier Dog
50	Carrier Dog Follower
51	Carrier Dog Follower Spring
52	Carrier Dog Pin
53	Carrier Dog Washer
54	Connector Pin
55	Disconnecter
56	Front Trigger Plate Bushing
57	Hammer
58	Hammer Pivot Pin
59	Hammer Plunger
60	Hammer Spring
61	Latch - Left
62	Latch - Right
63	Rear Trigger Plate Bushing
64	Right Connector
65	Safety Button
66	Safety Detent Ball
67	Safety Spring
68	Safety Spring Retaining Pin
69	Sear
70	Sear Pin
71	Sear Spring
72	Trigger
73	Trigger Pivot Pin
74	Trigger Plate
75	Trigger Plate Detent Spring

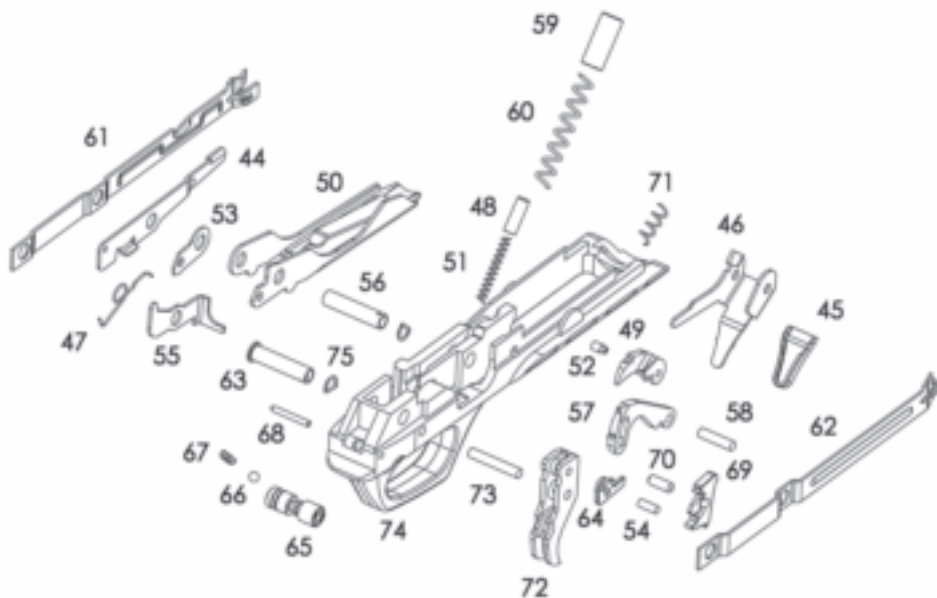

Note: parts are subject to change without notice.

HOW TO OBTAIN PARTS AND SERVICE FROM REMINGTON® ARMS COMPANY

To Order Parts:

Many Remington® Dealers and Authorized Repair Centers carry a full line of parts. Please check with them first before ordering parts.

To expedite your PARTS order or request REPAIR SERVICE visit our web site at www.remington.com. Detailed instructions are provided along with parts and/or service order forms. You may also reach Remington by calling our toll free customer service number, 1-800-243-9700, Mon.-Fri., 9:00 AM-5:00 PM Eastern time.

1. Fax completed order form (from the web site) to 1-336-548-7801.
2. To order by phone without the order form call 1-800-243-9700.

Please have the following information ready before you call.

- Firearm model and serial number.
- Part description and quantity. Part descriptions can be found on the parts listing page 20 in this manual.
- Your complete mailing address (P.O. Box and Street Address) including zip code, telephone number and e-mail address.
- Method of payment: MasterCard, Visa, Amex or Discover card number and expiration date. Prepayment may be made by check or money order. A quote may be made to you over the phone. (Sorry, no C.O.D.s.)

WARNING! USE ONLY REMINGTON PARTS IN REMINGTON'S FIREARMS.

NOTE: SOME PARTS MAY BE RESTRICTED. See parts list for details. Owner's manuals/instruction books may be requested via our web site at: www.remington.com or by calling 1-800-243-9700.

Repair Services

1. To locate the Remington Authorized Repair Center nearest you visit our web site at www.remington.com and use our Repair Service Locator. If you need additional on-line assistance, e-mail us at info@remington.com to obtain a listing of Authorized Repair Centers. Contact the Authorized Repair Center of your choice for evaluation of your firearm and/or additional shipping instructions.

2. If your Remington Authorized Repair Center cannot provide the service or repair you require and you need further assistance, please call our toll free number 1-800-243-9700, Mon.-Fri., 9:00 AM-5:00 PM Eastern time and select the option for repairs. Then, if shipment of your firearm is required, please:

- Record the serial number of your firearm before sending it to us.
- Pack your firearm for safety and to prevent further damage in shipping and handling. Preferably, ship in a firearm box.
- Remove all accessories from the firearm to prevent loss or damage.
- Enclose a letter with the firearm detailing the model name or number of your firearm and serial number along with a full description of the problem. Be sure to include your full name and address (P.O. Box and Street Address), including zip code, daytime telephone number and e-mail address.
- Ship your firearm by either United Parcel Service (UPS) or Parcel Post (US Post Office). Remington is not responsible for damage or loss during shipment, so you may elect to purchase insurance from your carrier.

Ship to: Remington Arms Company, Inc.
Attn: Arms Service Division/Repairs
14 Hoefler Ave.
Ilion, NY 13357

FIREARM OWNER'S RECORD

Model: _____

Serial # _____

Date Purchased: _____

Purchased From: _____

Price Paid: _____

Remember to complete and return the Firearm Warranty Registration Card in order to obtain full benefit of your Limited Two Year Firearm Warranty.

A WORD ON THE MAINTENANCE AND CARE OF YOUR REMINGTON FIREARM

Don't Alter or Modify Your Gun and Have it Serviced Regularly.

Your firearm has been designed to operate according to certain factory specifications. You'll jeopardize your safety and that of others around you by attempting to alter its trigger, mechanical safety or other mechanisms. Never alter or modify your firearm in any way.

Like any mechanical device, a firearm is subject to wear. It must be maintained and periodically serviced to assure optimum safety and performance. Only a qualified service facility should service, repair or modify your Remington® firearm. Consult your instruction book for location of the nearest Remington repair station. Remington recommends that you have your firearm professionally serviced annually. You should also have your firearm professionally serviced after prolonged storage, or if there is ever any question

pertaining to the proper functioning characteristics of your firearm.

Proper cleaning and lubrication are also important to firearm maintenance and are necessary to assure accuracy, safety and reliability. Before cleaning, always make sure that your gun is completely unloaded. And always clean the barrel from the chamber end to the muzzle when possible.

WARNING! DO NOT SEND LIVE OR SPENT SHELLS IN YOUR FIREARM OR IN THE SAME BOX WITH THE FIREARM. THIS IS A VIOLATION OF FEDERAL LAW. IF YOU FEEL YOU MUST SEND SPENT SHELLS, PLEASE SEND THEM IN A SEPARATE PACKAGE AND INCLUDE NAME, ADDRESS (WITH ZIP CODE), TELEPHONE NUMBER, MODEL AND SERIAL NUMBER OF YOUR FIREARM.