



TAURUS®

TCP SERIES INSTRUCTION MANUAL



General Safety,
Operating Instructions
and Limited Warranty

**READ CAREFULLY BEFORE
USING YOUR FIREARM**

**Important: Keep this manual with your
firearm.**

The information contained in this manual is useful, both for beginners and experienced shooters. In addition to important information about functioning, cleaning and care of the gun, the manual contains instructions that may be very helpful in shooting properly. The most important rule of safe gun handling is always keep the muzzle pointed in a safe direction!



ATTENTION

THIS BOOKLET

The safety warnings in this booklet are important. By understanding the dangers inherent in the use of any firearm, and by taking the precautions described herein, you can enjoy complete safety in the use of your Taurus firearm. Failure to heed any of these warnings may result in serious injury to you or others, as well as severe damage to the firearm or other property.

CONTENTS

1. Safety precautions Page 04

2. Get to know your pistol Page 13

Specifications Page 14

Taurus Security System Page 15

3. Ammunition Page 16

4. Operating instructions Page 19

5. Disassembly/Assembly Page 22

Disassembly Page 22

Assembly Page 24

6. Care and maintenance Page 25

7. Exploded view Page 27

Parts list Page 28

8. Taurus Service Policy Page 29

9. Taurus limited warranty Page 30

1. SAFETY PRECAUTIONS

PISTOLS are classified as FIREARMS or DANGEROUS WEAPONS and are sold by us with the specific understanding that we are not responsible in any manner whatsoever for their improper or negligent handling or resale under local laws and regulations.

Taurus shall not be responsible in any manner whatsoever for malfunctioning of the firearm, or for physical injury or property damage, resulting in whole or in part from (1) criminal or negligent discharge, (2) improper or careless handling, (3) unauthorized modifications, (4) defective, improper hand-loaded, or reloaded ammunition, (5) neglect, or (6) other influences beyond our direct and immediate control. This limitation applies regardless of whether liability is asserted on the basis of contract, negligence or strict liability (including any failure to warn). Under no circumstance shall Taurus be liable for incidental or consequential damages, such as loss of use of property, commercial loss and loss of earnings or profits.

SAFETY WARNINGS

NOT JUST FOR BEGINNERS

Regardless of your familiarity or experience with firearms, you need to study this manual.

The safe handling of firearms requires specialized training, discipline and caution. Firearms, by their nature and intended function, are deadly instruments. Accidental death or serious injury can result if they are handled improperly or carelessly.

Firearms rarely cause accidents. Firearms accidents almost always are caused by a failure to obey the basic rules of gun safety. Unfortunately, experienced shooters seem to violate these rules as frequently as beginners. Thus the basics of safe firearms handling cannot be repeated too often. Read, re-read and practice the basic principles of firearms safety until they become second nature: habits that you don't forget. If you have any question about your knowledge or ability to use this or any other firearm with complete safety you should seek supervised instruction. Personalized instruction is often available from firearms dealers, gun clubs, state hunter safety programs or police departments in the United States. If none of these sources is accessible, write to the National Rifle Association, 11250 Waples Mill Road, Fairfax, VA 22030 or at www.nra.org. THEY WILL ASSIST YOU.

A person with a firearm in his possession has a full-time responsibility. He must KNOW how to keep and use his firearm safely, and then must always TAKE the precautions necessary -all of them. He cannot guess; he cannot forget. This responsibility is his alone. It cannot be passed off to someone else. Remember: no firearm can be made accident-proof. A firearm is just a machine, with no judgement of its own. It responds to your actions, whether wise or foolish. The only truly effective safety device is the mind of a cautious shooter who never forgets that a moment's carelessness can produce permanent tragedy.

Firearms are not all alike

Many makes and models of firearms might LOOK nearly the same. However, they differ widely in design and operation, and in the location and function of various controls.

Study this manual thoroughly. Educate yourself on the characteristics and operation of your particular firearm before attempting to handle it. Do not permit others to handle it - unless they also have done so.

You should have an instruction manual for every firearm you own. If you do not, write the manufacturer and obtain one. Most manufacturers will gladly send you one free. If for any reason a manual is not available, visit your public library. Many books have been published which contain detailed information on obsolete or discontinued firearms.

You also may access the Taurus web site at taurususa.com to view and print manuals.

Your knowledge can prevent injuries.

Taurus firearms are designed and made to offer maximum safety when correctly used. However, as with any other weapon, it is not foolproof, and may become very dangerous if the next basic recommendations are not RIGIDLY observed:

**ALWAYS KEEP THE MUZZLE POINTED IN A SAFE DIRECTION
AND FINGER OFF THE TRIGGER.**

ATTENTION

WARNING: Pay special attention to the safety rules listed below.

NOTICE: Get instruction from a competent firearms instructor before using any firearm.

NOTICE: Never cock the firearm until you are ready to shoot.

DANGER: Never, never-ever point any firearm, loaded or unloaded, at anything you do not intend to shoot.

DANGER: Load and unload with the muzzle pointed in a safe direction.

DANGER: When receiving a firearm always check that it is unloaded (remove magazine and open slide to check if chamber is empty), even if you saw it done previously.

DANGER: Never put your hand over the muzzle of a firearm.

DANGER: Check ammunition to be sure it is the right size and caliber, and that it is not dented.

DANGER: WHILE HANDLING ANY FIREARM, NEVER ALLOW IT TO POINT AT ANY PART OF YOUR BODY OR AT ANOTHER PERSON. NO HARM SHOULD RESULT IF YOU OBEY THIS RULE, EVEN IF AN ACCIDENTAL DISCHARGE OCCURS.

DANGER: Don't try to change your firearm's trigger pull, because alteration of trigger pull usually affects sear engagement and may cause accidental discharge.

DANGER: Never engage a gun lock on a loaded firearm.

DANGER: This product is not intended for use by criminals, for use in the

commission of crimes or for any other wrongful purpose. Such uses constitute a misuse of the product and have a high likelihood of serious bodily injury or death for the criminal, the wrongdoer, law enforcement officers and/or innocent bystanders.

CAUTION: If there is any reason to suspect that a bullet is obstructing the barrel, immediately unload the firearm and look through the bore. It is not sufficient to merely look in the chamber.

WARNING: Keep your finger off the trigger until you are actually aiming at the target ready to shoot.

WARNING: Be certain the firearm is unloaded before cleaning.

WARNING: Always empty firearms before entering a place where there are people.

WARNING: Don't test the safety by pulling the trigger while the safety is on unless you are absolutely sure the firearm is empty and you are pointing the muzzle away from everyone and in a safe direction.

WARNING: Never pull a firearm towards you by the muzzle. Don't climb a tree or cross a fence with a loaded firearm.

WARNING: Never carry any handgun in your pocket, purse or waist-band. Use a pistol case or proper holster with safety flap or strap.

WARNING: Old or reloaded ammunition may be dangerous. We recommend against using it.

WARNING: Always treat every firearm as if it were loaded.

WARNING: Do not shoot or handle firearms after consuming beer, wine, other alcoholic beverages, any medications or other drugs that may affect your ability.

SAFETY FIRST: Never leave a loaded firearm unattended.

SAFETY FIRST: Store firearms and ammunition separately beyond the reach of children.

SAFETY FIRST: Be sure of your target and backstop before you shoot.

SAFETY FIRST: If a firearm fails to fire when the trigger is pulled, keep it pointed at the target for at least 30 seconds. Sometimes slow primer ignition will cause a “hang” fire and the cartridge will go off after a short pause.

SAFETY FIRST: Never shoot at hard flat surfaces or water. Bullet may ricochet.

SAFETY FIRST: Use a proper bench or support and aim the gun only if you intend to shoot.

SAFETY FIRST: Dry firing is bad for this firearm, whether the hammer block is engaged or not.

SAFETY FIRST: Treat this firearm as a precision instrument.

SAFETY FIRST: Write to us concerning any items or circumstances which might relate to your safety and the operation of our products.

SAFETY FIRST: Use a proper holster and draw only if you intend to shoot.

SAFETY FIRST: The safety is only a mechanical device, not a substitute for common sense.

WARNING

Taurus Pistols were manufactured to perform properly with the original parts as designed. It is your duty to make sure any parts you buy are installed correctly and that neither replacements nor originals are altered or changed. Your firearm is a simple tool but it has many parts that must relate correctly to other parts. Putting a firearm together with wrong or modified parts can result in a damaged firearm, danger and injury or death to you and others through malfunction. Always have a qualified gunsmith work on your firearm.

DANGER

THIS PISTOL IS CAPABLE OF FIRING WITH MAGAZINE REMOVED. INJURY OR DEATH MAY RESULT. NEVER POINT A LOADED PISTOL AT ANYONE OR ANYTHING YOU DO NOT INTEND TO SHOOT.

WARNING

To prevent injury or death, it is imperative that you must keep your firearm unloaded, securely locked, with ammunition in a separate location. In addition, take any other reasonable steps to limit the possibility of theft, crime, accident or suicide.

LOADING

- 1. DANGER:** Always make sure the muzzle is pointed in a safe direction.
- 2. SAFETY FIRST:** Never attempt to load or unload any firearm inside a vehicle, building or other confined space (except a properly constructed shooting range). Enclosed areas frequently do not offer a completely safe direction to point the firearm; if an accidental discharge occurs, there is a great risk of injury or property damage.
- 3. SAFETY FIRST:** Before loading, always clean all grease and oil from the bore and chamber, and check to be certain that no obstruction is in the barrel. Any foreign matter in the barrel could result in a bulged or burst barrel or other damage to the firearm, and could cause serious injury to the shooter or the others.

FIRING

1. DANGER: Keep the muzzle pointed in a safe direction and your finger away from the trigger when cocking any firearm.

2. WARNING: Never carry, handle or leave unattended any firearm which is cocked and ready-to-fire. When cocked, it will fire from slight pressure on the trigger. An accidental discharge could easily result if you fall or drop the firearm, or if the firearm is struck or disturbed by someone or something.

3. WARNING: Never fire any semi-automatic firearm with your finger, hand, face, or other part of your body over or adjacent to the ejection port, or in any position where you may be struck by reciprocating movement of the slide (or bolt). Both the ejection of the empty cartridge cases and the movement of the slide (or bolt) are part of the normal operating cycle of semi-automatic firearms, and pose no safety hazard to the shooter if the firearm is held in a normal grip and fired at arm's length (in the case of a handgun) as intended by its design.

4. CAUTION: Never allow other persons to stand beside you where they might be struck by an ejected cartridge case. The case is hot, and may be ejected with sufficient force to cause a burn, or cut, or injury to an unprotected eye. Make certain there is a clear, unobstructed path for safe ejection of the fired case. Remember, the case may bounce off a hard object nearby and strike you or someone else.

5. DANGER: If while shooting, your firearm develops ANY mechanical malfunction or binding, or "spits" powder, gas, or if a cartridge primer is punctured or a cartridge case is bulged or ruptured, or if the report on firing does not sound quite right, STOP SHOOTING IMMEDIATELY. It may be dangerous to continue. UNLOAD THE FIREARM. DO NOT try "one more shot". Take the firearm and ammunition to a gunsmith for examination.

6. SAFETY FIRST: While shooting any semi-automatic firearm, an unfired cartridge case may occasionally become jammed between the slide (or bolt) and the barrel. Clear the jam as follows, WHILE KEEPING THE MUZZLE POINTED IN A SAFE DIRECTION: Remove the magazine, then pull back the slide (or bolt) and hold or lock it to the rear. The jammed cartridge or case now can be removed by shaking it out or by picking it out.

SEMI-AUTOMATIC PISTOLS

1. SAFETY FIRST: Risk of an accident is greatly increased when any semi-automatic pistol, no matter how safely designed, is carried with a cartridge in the chamber. THIS PRACTICE IS NOT RECOMMENDED AND MAY BE JUSTIFIED ONLY IN CIRCUMSTANCE OF CLEAR AND PRESENT DANGER WHEN THE PISTOL MAY IMMEDIATELY HAVE TO BE USED IN SELF-DEFENSE. By far the safest procedure when carrying a loaded pistol is to leave the chamber empty.

2. SAFETY FIRST: Always point the muzzle in a safe direction when manually operating the slide to load the first cartridge from the magazine into the chamber. Malfunctions which allow the pistol to fire without the trigger being pulled when the slide snaps closed are rare but can happen. Always grip the slide so that your finger, hand, elbow and other parts of your body are BEHIND the pistol and your finger is off the trigger.

ALWAYS KEEP THE MUZZLE POINTED IN A SAFE DIRECTION
AND FINGER OFF THE TRIGGER.

2. GET TO KNOW YOUR PISTOL



TAURUS SECURITY SYSTEM

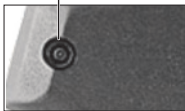

LOADED CHAMBER INDICATOR



**ALWAYS KEEP THE MUZZLE POINTED IN A SAFE DIRECTION
AND FINGER OFF THE TRIGGER.**

SPECIFICATIONS

MODEL	PT738	PT732
Caliber	.380 ACP	.32 ACP
Action	Double Action Only (DAO)	
Capacity	6+1 rounds	
Barrel length	2.84"	
Overall length	5.2"	
Overall height	3.75"	
Overall width	0.87"	
Sights	Front sight: Fixed Rear sight: Fixed	
Trigger pull	(5 - 7) lbs	
Weight (unloaded)	10.2 oz	10.5 oz
Materials	Slide: Stainless Steel or Steel Alloy Barrel: Stainless Steel Grip: Polymer with Metallic Subframe	
Safety Devices	Loaded Chamber Indicator	
Slide - finish	Matte Stainless Steel or Matte Blue	

TAURUS SECURITY SYSTEM

ATTENTION

Never engage the **Taurus Security System** on your Taurus Pistol with the **slide** in the **open** (rearward) position. This will result in permanent damage to your firearm.

Never attempt to engage the Taurus Security System on a Taurus pistol with a cartridge in the chamber.

Proceed as follow:

- Remove the **magazine**;
- Unload the gun by cycling the **slide**. **MAKE SURE THE CHAMBER IS EMPTY**;
- Engage the Taurus Security System;
- You may reinsert the magazine.

Engagement (secure)

Insert the **key** into the mechanism and turn **clockwise** until a click is felt or heard. The mechanism now partially protrudes above the surface of the grip. The action is locked in place and cannot function.

Disengagement (ready-to-fire)

To place the pistol in a firing condition, insert the **key** into the mechanism and turn it **counter-clockwise**. The mechanism is now virtually flush with the surface of the grip. The pistol can now be fired.

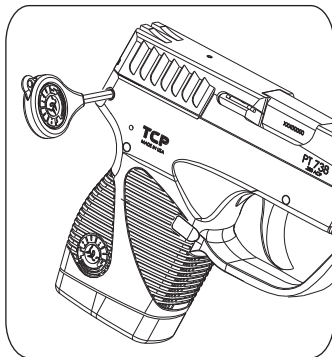

WARNING

Securing your firearm may inhibit access to it in a defense situation and result in injury or death.

WARNING

Failure to properly secure a firearm may result in injury or death.

**ALWAYS KEEP THE MUZZLE POINTED IN A SAFE DIRECTION
AND FINGER OFF THE TRIGGER.**

3. AMMUNITION

3.1 Use only high quality, original, factory-manufactured ammunition. Do not use cartridges that are dirty, wet, corroded, bent or damaged. Do not oil cartridges. Lubricant or other foreign matter on cartridges can cause potentially dangerous ammunition malfunctions. Use only ammunition of the caliber for which your firearm is chambered. The proper caliber is permanently engraved on your firearm; never attempt to use ammunition of any other caliber.

3.2 The use of reloaded (remanufactured) hand-loaded, or other non-standard ammunition voids all warranties. Improperly loaded ammunition can be extremely dangerous. Severe damage to the firearm and serious injury to the shooter or to others may result. Always use ammunition that complies with the industry performance standards established by the Sporting Arms and Ammunition Manufacturers Institute, Inc., of the United States, (SAAMI) or the equivalent from other countries.

3.3 Firearms may be severely damaged and serious injury to the shooter or to others may result from any condition causing excessive pressure inside the chamber or barrel during firing. Excessive pressure can be caused by obstructions in the barrel, propellant powder overload, or by the use of incorrect cartridges or defectively assembled cartridges. In addition, the use of a dirty, corroded, or damaged cartridge can lead to a burst cartridge case and consequent damage to the firearm and personal injury from the sudden escape of high-pressure propellant gas within the firearm's mechanism.

3.4 Immediately stop shooting and check the barrel for a possible obstruction whenever:

- You have difficulty in, or feel unusual resistance in, chambering a cartridge;
- A cartridge misfires (does not go off);
- The mechanism fails to extract a fired cartridge case;
- Unburned grains of propellant powder are discovered spilled in mechanism;
- A shot sounds weak or abnormal.

In such cases it is possible that a bullet is lodged part way down the barrel. Firing a subsequent bullet into the obstructed barrel can wreck the firearm and cause serious injury to the shooter or to bystanders.

3.5 Bullets can become lodged in the barrel.

- If the cartridge has been improperly loaded without propellant powder, or if the powder fails to ignite (ignition of the cartridge primer alone will push the bullet out the cartridge case, but usually does not generate sufficient energy to expel the bullet completely from the barrel).
- If the bullet is not properly seated tightly in the cartridge case. When such a cartridge is extracted from the chamber without being fired, the bullet may be left behind in the bore at the point where the rifling begins. Subsequent chambering of another cartridge may push

the first bullet further into the bore.

3.6 If there is any reason to suspect that a bullet is obstructing the barrel, immediately unload the firearm and look through the bore. It is not sufficient to merely look in the chamber. A bullet may be lodged some distance down the barrel where it can not easily be seen.

IF A BULLET IS IN THE BORE, DO NOT ATTEMPT TO SHOOT IT OUT BY USING ANOTHER CARTRIDGE, OR BY BLOWING IT OUT WITH A BLANK OR ONE FROM WHICH THE BULLET HAS BEEN REMOVED. SUCH TECHNIQUES CAN GENERATE EXCESSIVE PRESSURE, WRECK THE FIREARM AND CAUSE SERIOUS PERSONAL INJURY.

If the bullet can be removed with a cleaning rod, clean any unburned powder grains from the bore, chamber, and mechanism before resuming shooting. If the bullet cannot be dislodged by tapping it with a cleaning rod, take the firearm to a gunsmith. Dirt, corrosion, or other foreign matter on a cartridge can impede complete chambering and may cause the cartridge case to burst upon firing. The same is true of cartridges which are damaged or deformed.

3.7 Do not oil cartridges, and be sure to wipe the chamber clean of any oil or preservative before commencing to shoot. Oil interferes with the friction between cartridge case and chamber wall that is necessary for safe functioning, and subjects the firearm to stress similar to that imposed by excessive pressure.

3.8 Use lubricants sparingly on the moving parts of your firearm. Avoid excessive spraying of any aerosol firearm care product especially where it may get on ammunition. All lubricants and aerosol spray, lubricants in particular, can penetrate cartridge primers and cause misfires. Some highly penetrative lubricants can also migrate inside cartridge cases and cause deterioration of the propellant powder; on firing, the powder may not ignite. If only the primer ignites, there is danger that the bullet may become lodged in the barrel.

WARNING concerning ammunition marked “+P” and “+P+”. Recently there have been many developments by ammunition manufacturers and reloaders, not all of them good. It seems some ammunition manufacturers and reloaders are in a horsepower race to see who can develop the most case pressure and muzzle velocity with little regard for practicality or safety. Some of these loads exceed common sense and can virtually tear metal apart. Taurus Firearms rated for “+P” ammunition are rated for Sporting Arms and Ammunition Manufacturers Institute (SAAMI) compliant “+P” ammunition. **SAAMI does not recognize any “+P+” ammunition at all. It is DANGEROUS to fire “+P+” ammunition in any**

Taurus firearm and if you do so you may be seriously injured or killed.

In addition, it seems some ammunition marked "+P" is not SAAMI compliant either. **There are only four calibers that can carry a "+P" rating from SAAMI.** They are 38 Special +P, 9mm Luger +P, 38 Super Automatic and 45 Automatic +P. **There are no other SAAMI approved "+P" loads.** Any ammunition in any other caliber marked "+P" is not SAAMI compliant, may be dangerous and should not be used.

DANGER for "+P+"

Never use "Plus -P -Plus" (+P+) rated ammunition in any Taurus firearm. The Sporting Arms and Ammunition Manufacturers Institute (SAAMI) does not recognize such ratings and such ammunition can be very dangerous. Firing such ammunition can cause catastrophic failure in firearms resulting in serious bodily injury or death.

WARNING for "+P"

Only fire SAAMI rated Plus P ("+P") ammunition in Taurus Models designated by Taurus for +P use, as below. Firing +P ammunition in other Taurus products may be dangerous and can result in serious bodily injury or death.

Model 85 small frame revolver in 38 Special.

Model 850 small frame revolver in 38 Special.

Model 851 small frame revolver in 38 Special.

Model 85 Polymer small frame revolver in 38 Special.

Model 82 medium frame revolver in 38 Special.

Model 817 medium frame revolver in 38 Special.

All firearms chambered in 38 Super Automatic.

All firearms chambered in 45 Automatic.

All firearms chambered in 9mm Luger.

WARNING

Even if your Taurus firearm is rated for Plus P ("+P") ammunition, such ammunition generates pressures significantly in excess of the pressures associated with standard ammunition. Such pressures may affect the useful life of the firearm or exceed the margin of safety built into many firearms. Unless you need +P ammunition, do not use it, particularly for practice.

CAUTION

Discharging firearms in poorly ventilated areas, cleaning firearms, or handling ammunition may result in exposure to lead and other substances known to cause birth defects, reproductive harm, and other serious physical injury. Have adequate ventilation at all times. Wash thoroughly after exposure.

4. OPERATING INSTRUCTIONS

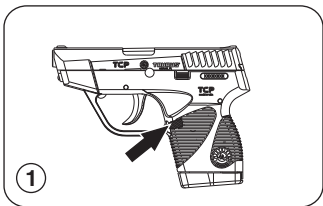

1. To remove the magazine press the **magazine release button**, located near the **trigger guard**, with your thumb.

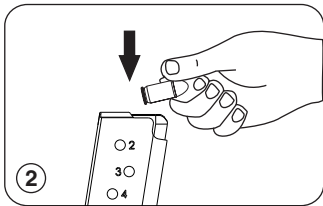

2. Hold the **magazine** with one of your hands and with the other one insert the cartridges one at a time, pressing them down and to the rear. Insert the **magazine** into the pistol until it is held by the **magazine catch**. If the **magazine** is not correctly inserted into the pistol, it can be dropped when you intend to shoot.

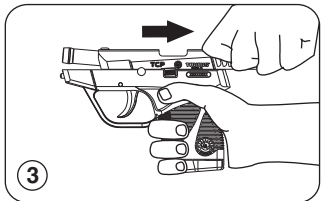

3. Hold the pistol with one hand keeping your finger away from the trigger. With the other hand pull the **slide** to its limit and release it, so **slide** will go forward under **recoil spring** pressure and will insert one cartridge in the chamber.

**ALWAYS KEEP THE MUZZLE POINTED IN A SAFE DIRECTION
AND FINGER OFF THE TRIGGER.**

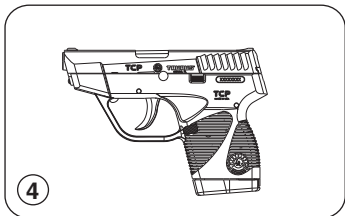

4. The pistol is **ready** for instant use. If the pistol is not to be use immediately, the **magazine** should be removed and the **chamber** unloaded. When the pistol is in the “semi-cocked” mode, the first shot can be fired **double-action** by pulling the trigger all the way to the rear, which fully

cocks and releases the hammer and then fires the pistol. Subsequent shots are fired in the same way by releasing and then pulling the trigger until the magazine is empty, the hammer being semi-cocked by the slide as it recoils from each shot. **After a shot is fired, the trigger must be allowed to move fully forward.** If the trigger is pulled before the trigger mechanism fully resets (two “clicks”) the hammer may or may not fire the cartridge.

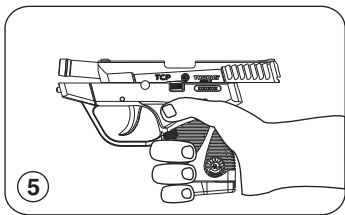

5. Immediately following the firing of a shot, and if a subsequent shot is not to be fired at once, remove the **magazine** and lock the slide back using the **slide catch**. Be sure the chamber is empty. If the **slide** is shut, the shooter should always assume that there is a **cartridge** in the

chamber! Don't rely on your memory to know if a gun or magazine is loaded. **Visually inspect the magazine and chamber.**

WARNING: These Taurus pistols do not have a magazine disconnect (safety). They are capable of firing with magazine removed.

ALWAYS KEEP THE MUZZLE POINTED IN A SAFE DIRECTION
AND FINGER OFF THE TRIGGER.

PROTECT YOUR EYES AND EARS

Always wear adequate shooting glasses and ear plugs or “ear muff” type protectors whenever you are shooting. Always make certain that persons close to you are similarly protected. Unprotected eyes may be injured by powder, gas, carbon residue, lubricant, metallic particles or similar debris which may emanate occasionally from any firearm in normal use. Without ear protection, repeated exposure to shooting noise may lead to cumulative, permanent hearing loss.

Empty cartridges are automatically ejected from your pistol at a considerable speed and may cause injury to people close to you. The pistol slide moves backwards during the shot. Therefore, keep your face away from the pistol. Do not use double-holding, a condition in which the thumb of the hand not used to hold the pistol stays over the other hand.



**ALWAYS KEEP THE MUZZLE POINTED IN A SAFE DIRECTION
AND FINGER OFF THE TRIGGER.**

5. DISASSEMBLY

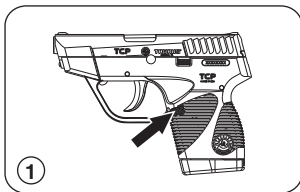

1. Remove the **magazine** by pressing the **magazine release**.

WARNING: After removing the magazine always check for loaded chamber.

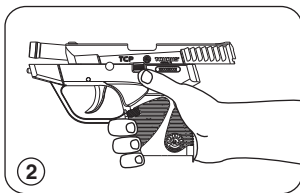

2. Pull **slide** to the rear and lock in the open position by pushing upward on the **slide catch lever**.

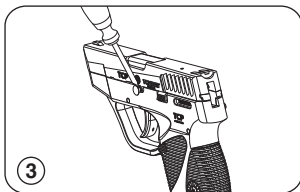

3. Loosen the **disassembly latch** using a screwdriver or other flat tool. Remove the **disassembly latch** completely.

WARNING:

While removing the disassembly latch make sure that the slide won't be damaged (scratched).

The tool is not included.

**ALWAYS KEEP THE MUZZLE POINTED IN A SAFE DIRECTION
AND FINGER OFF THE TRIGGER.**

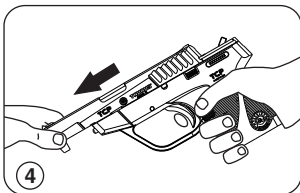

4. Carefully release **slide catch**, pull **slide** forward off of the **frame**.

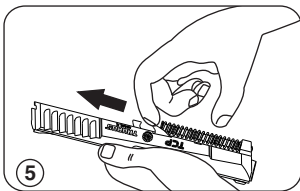

5. Release **recoil spring assembly** from its position on the bottom of the **barrel**.

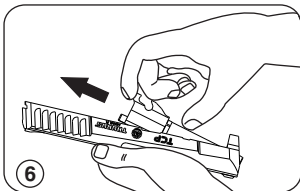

6. Remove the **barrel** from the **slide** by pulling to the front and up.

ATTENTION: No further disassembly is recommended unless done by a skilled gunsmith.

ASSEMBLY

In order to assemble the pistol, proceed by reversing the disassembling procedure while observing the following details:

1. Replace the **barrel** in the **slide** pushing it to the rearward position. Insert the **spring/guide rod** sub assembly into the **slide** over the **barrel**, compressing the spring slightly to get it into position.

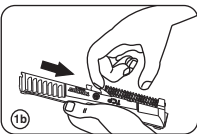
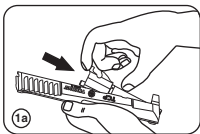

2. The **slide** should be mounted on the frame and pulled fully to the rear and the **slide catch** must be moved upward to hold the **slide** to the rear.

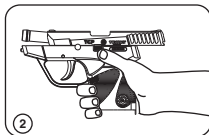

3. When reinstalling the **DISASSEMBLY LATCH**, you must make sure that the **barrel** is fully forward in the **slide**. The **pin** must be pushed through the **frame** and the mating portion of the bottom of the **barrel**. Once these parts have been lined up, and you gently push the latch in, a click will be heard indicating that the **PIN** is secured in place.

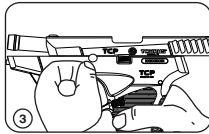

4. The **slide catch** then can be depressed which allows the **slide** to go forward.

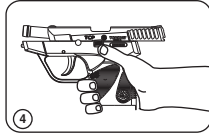

5. You should cycle the **slide** several times, with no magazine inserted and no rounds in the chamber, to insure that the **barrel/slide/frame** relationship is correct.

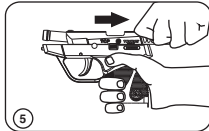

**ALWAYS KEEP THE MUZZLE POINTED IN A SAFE DIRECTION
AND FINGER OFF THE TRIGGER.**

6. CARE AND MAINTENANCE

WARNING: Be certain the firearm is unloaded before cleaning.

The firearm may be cleaned and lubricated under normal conditions with the disassembly steps described in section 5

- In special conditions, such as repairs, when disassembling is necessary, it is recommended the firearm be sent to a competent gunsmith or the importer.
- In order to keep a firearm in perfect condition it must be kept clean and covered with a slight film of good quality oil to prevent corrosion. This is especially necessary after use.
- For normal cleaning of firearm not used or kept in storage for some time, it is necessary to rub it with a lightly oiled cloth. In the same way proceed with the bore of the barrel. The excess of oil must be removed
- For cleaning after shooting it is of special importance that all residues of powder be removed from barrel and other adjacent areas using an appropriate brush. If particles of lead are detected in barrel they must be scrubbed with a brass brush, drenched with oil. Once cleaned, lubrication should be done as above described.
- Every time you shoot your firearm, it must be cleaned regardless of the number of shots fired. If you shoot more than 200 shots in a day, clean your firearm every 200 shots.
- The magazine also must be cleaned to keep the firearm in good operating condition. The magazine shall be disassembled as follows:

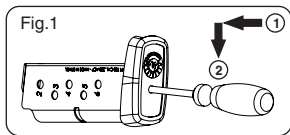

A) Use a **punch** to press the **magazine plate** down, then **pull** the magazine bottom out of the magazine body.

Attention: Please take care to prevent the forcible ejection of the magazine spring plate and compressed magazine spring.

B) Withdraw magazine spring plate and magazine spring from magazine body. Turn magazine upside down and remove magazine follower.

C) Reassemble in **reverse** order.

**ALWAYS KEEP THE MUZZLE POINTED IN A SAFE DIRECTION
AND FINGER OFF THE TRIGGER.**

SAFETY FIRST: PARTS

All firearms require periodic maintenance and inspection which may reveal a need for adjustment or repair. Have your firearm checked by a competent gunsmith annually, even if it seems to be working well, since breakage, improper functioning, undue wear, or corrosion of some components may not be apparent from external examination. If you notice ANY mechanical malfunction, do NOT continue to use the firearm. UNLOAD the firearm and take it to a competent gunsmith immediately.

Similarly, if water, sand, or other foreign matter enters the internal mechanism, the firearm should be dismantled for complete and thorough cleaning. Failure to keep your firearm clean and in proper working order can lead to a potentially dangerous condition.

Our Service Department maintains a full complement of replacement parts for our firearms of current manufacture. Even though most gunsmiths have the knowledge, training and ability to make the necessary repairs to your firearm, the skill and workmanship of any particular gunsmith is totally beyond our control. Should your firearm ever require service, we strongly recommend that you return it to Taurus. Follow the instructions outlined below. Remember, unauthorized adjustments or parts replacement can void your warranty.

It is the responsibility of the purchaser to be absolutely certain that any parts ordered from Taurus are of the correct type and are properly fitted and installed by a competent person. THIS FIREARM IS A PRECISION MECHANISM AND THE IMPROPER FITTING OF PARTS OR IMPROPER MECHANICAL ADJUSTMENT MAY RESULT IN A DANGEROUS MALFUNCTION, DAMAGE TO THE FIREARM, AND POSSIBLE SERIOUS INJURY TO THE SHOOTER OR TO OTHERS.

Therefore, the purchaser and/or installer of parts must accept full responsibility for the correct adjustment of and function of the firearm after such installation has been made or attempted.

Exploded View

(Please have your serial number ready when calling to order any parts)

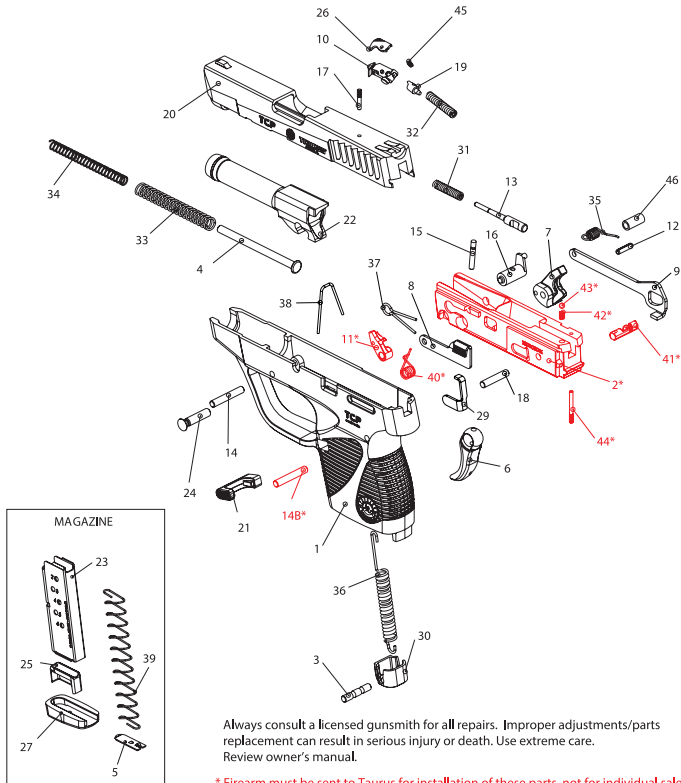

Always consult a licensed gunsmith for all repairs. Improper adjustments/parts replacement can result in serious injury or death. Use extreme care. Review owner's manual.

* Firearm must be sent to Taurus for installation of these parts, not for individual sale.

Recoil Spring Kit #53

(Please have your serial number ready when calling to order any parts)

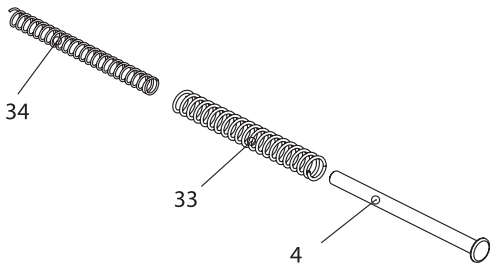

Slide Latch Kit #54

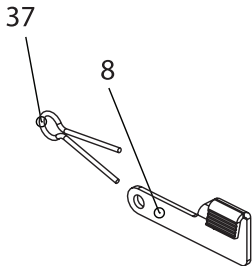

Extractor Kit #55

(Please have your serial number ready when calling to order any parts)

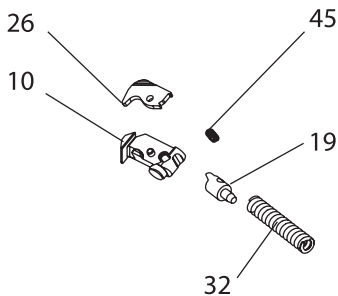

Sear Kit #56

RESTRICTED

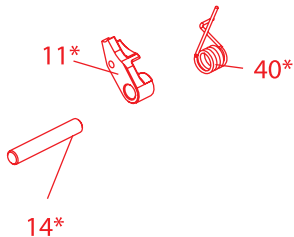

* Firearm must be sent to Taurus for installation of these parts, not for individual sale.

Firing Pin Kit #57

(Please have your serial number ready when calling to order any parts)

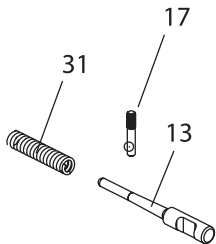

Magazine Release Kit #58

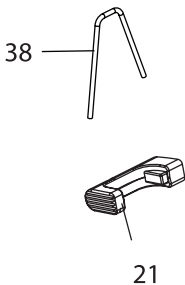

Slide Kit #59, #59A, #59B

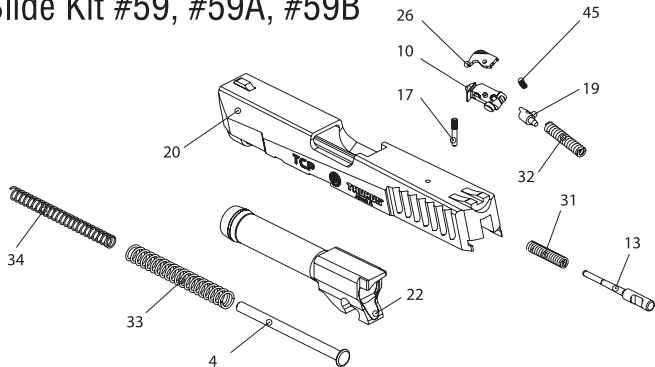

(Please have your serial number ready when calling to order any parts)

Grip Kit #60, #60A

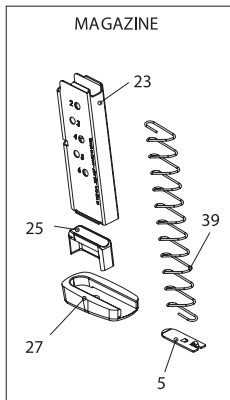
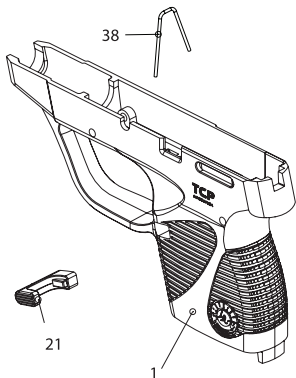

Parts List

Manual Number	Description	Part Number	Restricted	Retail
1	Polymer Grip (Black-TCP)	26051613	No	\$ 29.95
1A	Polymer Grip (Carbon Fiber-TCP)	26051613CF	No	\$ 29.95
1B	Polymer Grip (White-TCP)	26051613W	No	\$ 29.95
1C	Polymer Grip (Grey-TCP)	26051613G	No	\$ 29.95
1D	Polymer Grip (Hot Pink-TCP)	26051613HP	No	\$ 29.95
1E	Polymer Grip (Pink-TCP)	26051613P	No	\$ 29.95
1F	Polymer Grip (Raspberry-TCP)	26051613R	No	\$ 29.95
1G	Polymer Grip (Lavender-TCP)	26051613L	No	\$ 29.95
1H	Polymer Grip (Yellow-TCP)	26051613Y	No	\$ 29.95
2	Aluminum Frame (TCP)	26003848	Yes	
3	Hammer Spring Pin (TCP)	26012570	No	\$ 1.00
4	Recoil Spring Pin (TCP)	26051605	No	\$ 2.35
5	Magazine Spring Plate (TCP)	26119420	No	\$ 1.72
6	Trigger (TCP)	26012510	No	\$ 1.00
7	Hammer (TCP)	36124982	No	\$ 4.27
8	Slide Stop (TCP)	36124974	No	\$ 1.00
9	Trigger Bar (TCP/Curve)	26018500	No	\$ 5.84
10	Extractor (TCP)	26051761	No	\$ 2.42
11	Sear (TCP)	26012537	Yes	
12	Barrel Spring Pin (TCP)	26012561	No	\$ 1.00
13	Firing Pin (TCP)	26051591	No	\$ 2.73
14A	Grip Pin (TCP)	26012600	No	\$ 1.00
14B	Grip Pin (TCP)	26012600	Yes	
15	Trigger Pivot Pin (TCP)	26012006	No	\$ 1.00
16	Trigger Pivot (TCP)	26011999	No	\$ 2.56
17	Firing Pin Guide (TCP)	26011980	No	\$ 1.00
18	Hammer Pin (TCP)	26012553	No	\$ 1.12
19	Extractor Spring Pin (TCP)	26011972	No	\$ 4.55
20	Slide Stainless Steel (PT 738)	26033380	No	\$ 99.95
20A	Slide Carbon Steel (PT 738)	26033380B	No	\$ 99.95
20B	Slide Stainless Steel (PT 738)	26033380BSS	No	\$ 99.95
21	Magazine Release (TCP)	36124966	No	\$ 1.00
22	Barrel (PT 738)	26005620	No	\$ 39.99
23	Magazine Body (PT 738)	26119404	No	\$ 15.00
24	Disassembly Pin (TCP)	26012588	No	\$ 1.40
25A	Magazine Follower (PT 738)	26119412	No	\$ 1.79

Parts List (continued)

Manual Number	Description	Part Number	Restricted	Retail
26	Loaded Chamber Plate (TCP)	26051990	No	\$ 2.91
27	Magazine Bottom (TCP)	11-1015	No	\$ 1.00
29	Ejector (TCP)	26003937	No	\$ 1.00
30	Grip Cap (TCP)	26012529	No	\$ 1.00
31	Firing Pin Spring (TCP)	26040832	No	\$ 1.00
32	Extractor Spring (TCP)	26040891	No	\$ 1.00
33	External Recoil Spring (PT 738)	26040840	No	\$ 1.00
34	Internal Recoil Spring (PT 738)	26040859	No	\$ 1.00
35	Trigger Spring (TCP)	26040875	No	\$ 1.00
36	Hammer Spring (PT 738)	26040930	No	\$ 1.00
37	Slide Catch Spring (TCP)	26040883	No	\$ 1.00
38	Magazine Release Spring (TCP)	26040948	No	\$ 1.00
39	Magazine Spring (TCP)	26040913	No	\$ 3.40
40	Sear Spring (TCP)	26040964	Yes	
41	Lock Screw (TCP)	36125110	Yes	
42	Keylock Spring (TCP)	26041707	Yes	
43	Keylock Ball(TCP)	36350028	Yes	
44	Lock Screw Retaining Pin (TCP)	26012898	Yes	
45	Loaded Chamber Spring (TCP)	26041227	No	\$ 1.00
46	Frame Bushing (TCP)	26021340	No	\$ 2.80
53	Recoil Spring Kit (PT 738)	36100870	No	\$ 2.87
54	Slide Latch Kit (TCP)	36101010	No	\$ 1.00
55	Extractor Kit (TCP)	36101028	No	\$ 10.06
56	Sear Kit (TCP)	36101036	Yes	
57	Firing Pin Kit (TCP)	36002330	No	\$ 3.26
58	Magazine Release Kit (TCP)	36101133	No	\$ 2.00
59	Slide Kit (Stainless Steel PT 738)	36101087	No	\$ 160.89
59A	Slide Kit (Matte Blue PT 738)	36101095	No	\$ 160.89
59B	Slide Kit (Black Stainless PT 738)	36101109	No	\$ 160.89
60	Grip Assembly (TCP)	36101141	No	\$ 74.34
60A	Grip Assembly (PT 738)	36101150	No	\$ 97.33

8. TAURUS SERVICE POLICY

Before shipment, your firearm was carefully inspected and test fired in order to ensure that it conformed to our specifications and standards. Should your firearm require adjustment or repair, we strongly recommend that you return it to Taurus for factory service.

If there is any question regarding the performance of your firearm, please write to our Service Department fully describing all circumstances and conditions involved. If our Service Department makes the determination that your firearm requires factory service, you will be so advised and will be given instructions for the most expeditious handling of your shipment.

Our Service Department will give your firearm a complete inspection, and evaluate the problem (s) specified in your letter. If the work required is not covered under the terms of our "Warranty" (when applicable) you will receive an actual cost quotation, not an estimate. Any charge for repair work must be authorized by you, and no work will be done without your expressed approval.

Please follow these suggestions to expedite service in the United States of America to return any firearm to us for adjustment or repair.

1. Federal law permits you to return your firearm to the manufacturer for service via common carriers. However, state and local firearms laws vary greatly; you should consult your local prosecuting attorney regarding any restrictive laws in your jurisdiction regarding your shipment or receipt of firearms. With the above in mind, it is strongly recommended that any firearm sent to us for repair be sent through a Federally licensed dealer.

2. All firearms must be shipped to us prepaid. **WE WILL NOT ACCEPT COLLECT SHIPMENTS.**

Ship to: Taurus Customer Service, 16175 N.W. 49 Ave., Miami, FL 33014.

3. Be sure to enclose a letter stating your name, address and telephone number, serial number, caliber and barrel length of your firearm. Also state nature of trouble experienced or work required. Merely stating "defective" or "repair as necessary" is inadequate information. Be specific and enclose copies of any previous correspondence. Work (other than warranty repair) will bear minimum labor charge of \$10.00.

4. **FIREARMS MUST BE SHIPPED UNLOADED.** Double check the chamber of your firearm before shipping. If firearms are sent to Taurus in a loaded condition, we are required by law to notify the Federal authorities.

5. **DO NOT** include telescopic sights; custom grips, holsters, or other accessories with any firearm shipped to us.

9. TAURUS LIMITED WARRANTY

What Does This Warranty Cover?

This warranty covers any service and repair needed by any product manufactured in the United States by Taurus International Manufacturing, Inc.

How Long Does Coverage Last?

This warranty is of unlimited duration.

What Will We Do?

Taurus will service and/or repair all covered products free of charge.

What Does This Warranty Not Cover?

This warranty does not cover grips, sights, accessories, cosmetic defects after one year, or damage caused by customer abuse at any time. This express limited warranty is the only warranty on this product. This product is sold "as is" and has no implied warranties of merchantability or fitness for a particular purpose. There are no warranties which extend beyond the description on the face hereof.

How Do I Get Service?

To simplify repair and service Taurus International products are serviced and repaired by Taurus International. Questions regarding the products can be directed to Taurus International in Miami, Florida at 1-305-624-1115 or in writing to:

16175 NW. 49th Avenue
Miami, Florida 33014
In care of Customer Service.

TAURUS NEWS

If you desire to receive periodic e-mails relating to new products from us, you may utilize our product enrollment web page at <http://www.taurususa.com/product-enrollment.cfm>

Privacy Statement - We do not share, sell or reveal customer information. This information is for our records only. Your e-mail address and purchase information will be kept confidential.



This trademark, forged for 70 years of hard and dedicated work, became a symbol of quality in hand- guns for civilian, police and military use. This outstanding quality is the result of constant technological evolution and from the devoted work of expert gunsmiths and highly specialized professionals, which makes TAURUS a respected name in more than 75 countries all over the world.

IMPORTANT

DO NOT DISCARD

KEEP THIS MANUAL WITH
YOUR FIREARM UPON
CHANGE OF OWNERSHIP.

TAURUS INTERNATIONAL
MANUFACTURING, INC.

16175 NW 49 Avenue
Miami, Florida 33014

Telephone: (305) 624 1115

Fax: (305) 624 1126

www.taurususa.com
www.taurus.com.br

