



THOMPSON/CENTER
America's Master Gunmaker®

Safety & Instruction Manual

T/C® Dimension® Bolt Action Rifle



This Manual is for both right-hand & left-hand models. The instructions are written for the right-hand version. The left-hand version is simply a mirror image and the instructions are basically the same.



**Read the instructions and
warnings in this manual
CAREFULLY BEFORE
using this firearm.**

THOMPSON/CENTER ARMS
2100 Roosevelt Avenue • Springfield, MA 01104
Toll Free Phone (866) 730-1614
Web site: www.tcarms.com
Customer Service Email:
tca_customerservice@tcarms.com



WARNING



**READ THESE
INSTRUCTIONS AND
WARNINGS CAREFULLY.
BE SURE YOU UNDERSTAND
THESE INSTRUCTIONS AND WARN-
INGS BEFORE USING THIS FIREARM.
FAILURE TO READ THESE INSTRUC-
TIONS AND TO FOLLOW THESE WARN-
INGS MAY RESULT IN SERIOUS INJURY
OR DEATH TO YOU AND OTHERS
AND DAMAGE TO PROPERTY**

**This SAFETY & INSTRUCTION
MANUAL should always accompany
this firearm and be transferred with it
upon change of ownership or when the
firearm is presented to another person.**

**Always keep your firearm pointed in a
safe direction. Never point a firearm at
anything you do not intend to shoot.**

**If you don't have a manual, printed
copies are available free upon request
by contacting the factory at the address
below. They are also available via
download from the company's web site
shown below.**

**THOMPSON/CENTER ARMS
• CUSTOMER SUPPORT •**

2100 Roosevelt Avenue

Springfield, MA 01104

TEL. Toll Free (866) 730-1614

www.tcarms.com

TABLE OF CONTENTS

YOUR SAFETY RESPONSIBILITIES	3-6
SAFE STORAGE AND TRANSPORTATION	7-8
PREPARATION FOR FIRING	9
AMMUNITION	10-11
MODEL AND FEATURES IDENTIFICATION	12
INSPECTION AND INITIAL ASSEMBLY	13-15
LOADING.....	16
FIRING	17
CLEARING MISFIRES	18
UNLOADING.....	18
DISASSEMBLY / FIELD STRIPPING	19
SCOPE MOUNT	20-21
MAKING TRIGGER ADJUSTMENTS	21-22
CLEANING AND MAINTENANCE	23-24
CONVERSION PARTS	25-26
CHANGING A BARREL	27-32
CHANGING A STOCK	32-33
STOCK LENGTH SPACERS	33-34
ACCESSORY LOC™ SCOPE MOUNT APPENDIX	34-38
LIMITED LIFETIME WARRANTY	39-40
CONTACT AND SHIPPING FOR SERVICE.....	41-42
PATENT INFORMATION	43
CONTACTS.....	44

YOUR SAFETY RESPONSIBILITIES

SAFETY IS YOUR NUMBER ONE RESPONSIBILITY!!!!

- At home, in the field, at the range, or anywhere, the first concern of every firearm owner should be safety. Apply the following safety rules in every situation, with any kind of firearm. If you feel uncertain about any operational aspects of your firearm, please contact Thompson/Center before proceeding with its operation.
- If you are unfamiliar with firearms you should seek formal training before using your rifle.



WARNING: YOU MUST FOLLOW ALL OF THESE SAFETY RULES TO ENSURE THE SAFE USE OF YOUR FIREARM. THE FAILURE TO FOLLOW THE INSTRUCTIONS AND WARNINGS IN THIS MANUAL COULD CAUSE SERIOUS PERSONAL INJURY OR DEATH TO YOU OR OTHERS AND DAMAGE TO PROPERTY.

- As a firearm owner, you accept a demanding responsibility. How seriously you take this responsibility can be the difference between life and death. There is no excuse for careless or abusive handling of your firearm. At all times handle your firearm with intense respect for its power and potential danger.

YOUR SAFETY RESPONSIBILITIES CONTINUED

- **ALWAYS KEEP YOUR FIREARM POINTED IN A SAFE DIRECTION.** Never point a firearm at anyone or anything you do not intend to shoot whether or not it is loaded. This is particularly important when loading, unloading, or field stripping the firearm. ALWAYS control the direction of the firearm.
- **ALWAYS TREAT EVERY FIREARM AS IF IT IS LOADED AND WILL FIRE.** Do not take anyone's word that the firearm is unloaded – always check for yourself. Never pass your firearm to another person until the action is open and you visually check that it is unloaded. Keep your firearm unloaded and safely stored when not in use.
- **NEVER PLACE YOUR FINGER INSIDE THE TRIGGER GUARD OR ON THE TRIGGER UNLESS YOU INTEND TO FIRE.** Ensure that other objects do not touch the trigger.
- **ALWAYS BE SURE OF YOUR TARGET AND WHAT IS BEYOND IT.** Always be sure of where the bullet will strike and shoot only where there is a safe back stop free of obstructions, water or other surfaces which can cause ricochets. Be sure your bullet will stop behind your target. Bullets can glance off many surfaces like rocks or the surface of water and travel in unpredictable directions with considerable velocity. Do not fire randomly into the sky.
- **NEVER CROSS OBSTACLES SUCH AS FENCES OR STREAMS WITH A LOADED FIREARM.** Always make certain your firearm is unloaded before crossing a fence, climbing a tree, jumping a ditch or negotiating other obstacles.
- **SAFE FIREARM HANDLING IS YOUR PERSONAL RESPONSIBILITY AT ALL TIMES.** Firearms are dangerous and can cause serious injury or death if they are misused or used inappropriately. Safety must be the prime consideration of anyone who owns or handles firearms. Accidents are the result of violating the rules of safe firearm handling and common sense. Firearm safety training is available. Contact your firearms dealer, law enforcement agency, local sportsman's club, etc. for availability.
- **YOU ARE RESPONSIBLE FOR THE FIREARM AT ALL TIMES.** In owning a firearm, you must undertake full-time responsibility for your firearm's safety and security. You must protect yourself and all others against injury or death from misuse of the firearm 24 hours a day.
- **FIREARM SECURITY IS YOUR RESPONSIBILITY.** You must secure firearms safely from children and/or unauthorized users. Your firearm should always be kept unloaded and locked when not in use. Never assume that the use of this lock is sufficient to safely secure your firearm. You must always evaluate your personal situation and employ the security systems that meet your needs and prevent children and unauthorized users from gaining access to your firearm.

YOUR SAFETY RESPONSIBILITIES CONTINUED

- **APPROPRIATE USE FOR YOUR FIREARM MEANS USING YOUR FIREARM FOR LEGAL PURPOSES.** For example - target shooting, hunting and lawful resistance of deadly criminal force. It is your responsibility to ensure that you are in compliance with all applicable laws and ordinances regarding the use of your firearm.
- **NEVER RELY ON MECHANICAL FEATURES ALONE.** Only your safe firearm-handling habits will ensure the safe use of your firearm. This is your responsibility.
- **ALWAYS SAFELY STORE AND SECURE YOUR FIREARM.** Safe and secure storage of your firearm is one of your most important responsibilities. It is a full-time responsibility. You must always secure your firearm and ammunition separately so that they are not accessible to children and/or other unauthorized persons.
- **NEVER KEEP AMMUNITION IN THE SAME LOCATION AS THE FIREARM.** Store each in a separate and secure place.
- **ALWAYS WEAR EYE PROTECTION THAT IS SPECIFIED FOR USE WITH FIREARMS** every time you handle your firearm for cleaning and maintenance.
- **ALWAYS WEAR EYE AND HEARING PROTECTION THAT ARE SPECIFIED FOR USE WITH FIREARMS** every time you discharge your firearm. Make sure others in the vicinity of where you will be shooting do so as well.
- **NEVER USE ALCOHOL OR DRUGS BEFORE OR WHILE SHOOTING.** Do not use your firearm if you are on any medication which impairs, even slightly, your mental or physical ability.
- **ALWAYS HAVE ADEQUATE VENTILATION.** Discharging firearms in poorly ventilated areas, cleaning firearms, or handling ammunition may result in exposure to lead and other substances known to cause birth defects, reproductive harm, and other serious physical injury. Review the warnings and labels for all ammunition and cleaning products carefully. Wash hands thoroughly after exposure.
- **BEFORE HANDLING ANY FIREARM, UNDERSTAND ITS OPERATION.** Not all firearms are the same. Familiarize yourself with the mechanical features of any firearm you intend to use. If you feel uncertain about any operational aspects of your firearm, please contact Thompson/Center before proceeding with its operation.
- **NEVER ALLOW A FIREARM TO BE USED BY INDIVIDUALS WHO DO NOT UNDERSTAND ITS SAFE OPERATION OR HAVE NOT READ THESE FIREARM SAFETY RULES.**

YOUR SAFETY RESPONSIBILITIES CONTINUED

- **ALWAYS USE THE CORRECT AMMUNITION FOR YOUR PARTICULAR FIREARM** as indicated by the marking on the firearm. Never use non-standard, reloaded or “handloaded” ammunition which has not been subjected to internal ballistic pressure testing.
- **BEWARE OF BARREL OBSTRUCTIONS** Be sure the barrel is clear of obstructions before shooting. Mud, water, snow or other objects may inadvertently lodge in the barrel bore. A small obstruction can cause a dangerous increase in pressure and may damage your firearm and cause injury to yourself and others.
- **BE SURE ALL ACCESSORIES, SUCH AS HOLSTERS, GRIPS, SLINGS, SCOPES AND OTHER ACCESSORIES ARE COMPATIBLE** with the firearm and that the accessories do not interfere with safe operation. It is your responsibility to understand and follow all of the instructions in this manual, as well as those which may be supplied with your ammunition and any accessory.
- **NEVER DISASSEMBLE YOUR FIREARM** beyond the field stripping procedure outlined in this manual. Improper disassembly or reassembly of your firearm may be dangerous and can lead to serious injury or death.
- **NEVER MANIPULATE, ADJUST OR CHANGE ANY OF THE INTERNAL COMPONENTS OF YOUR FIREARM UNLESS SPECIFICALLY INSTRUCTED TO DO SO IN THIS MANUAL.** Improper manipulation of any other internal component may affect the safety and reliability of your firearm and may cause serious injury or death.
- **NEVER ALLOW ANY ALTERATION OR REPLACEMENT OF PARTS IN YOUR THOMPSON/CENTER FIREARM UNLESS PERFORMED BY A QUALIFIED GUNSMITH** using genuine Thompson/Center parts. If you do otherwise, improper functioning of your firearm may occur and serious injury or death and damage to property may result.



WARNING: SAFE USE OF A FIREARM IS YOUR PERSONAL RESPONSIBILITY AND THE FAILURE TO FOLLOW ALL OF THESE BASIC SAFETY RULES MAY RESULT IN SEVERE PERSONAL INJURY OR DEATH TO YOU OR OTHERS. YOU ARE THE MOST IMPORTANT SAFETY DEVICE WHEN IT COMES TO THE USE OF YOUR FIREARM AND THOMPSON/CENTER AND ITS PARENT COMPANY WILL NOT BE RESPONSIBLE FOR ANY PERSONAL INJURY, DEATH OR PROPERTY DAMAGE THAT RESULTS FROM:

(1) THE CRIMINAL OR NEGLIGENT USE OF THIS FIREARM; (2) A DISREGARD OF THESE SAFETY INSTRUCTIONS AND WARNINGS; (3) IMPROPER OR CARELESS HANDLING OF THIS FIREARM; (4) THE USE OF NON-STANDARD, DEFECTIVE, IMPROPER AMMUNITION; OR (5) IMPROPER OR NEGLIGENT MODIFICATIONS OR REPAIRS TO THE FIREARM.

SAFE STORAGE AND TRANSPORTATION



WARNING: ALWAYS POINT THE MUZZLE IN A SAFE DIRECTION.



WARNING: FIREARMS ARE DANGEROUS WHEN USED AND STORED IMPROPERLY. THEY POSE A RISK OF SERIOUS OR FATAL INJURIES. FIREARMS CAN BE ESPECIALLY DANGEROUS TO CHILDREN WHEN THEY ARE STORED IN AN IRRESPONSIBLE AND UNSAFE MANNER. FOR YOUR SAFETY AND THE SAFETY OF OTHERS, IT IS IMPERATIVE THAT YOU KEEP YOUR FIREARM LOCKED AND UNLOADED IN A SECURE PLACE. THE AMMUNITION SHOULD BE STORED IN A SEPARATE, SECURE LOCATION WHEN IT IS NOT IN USE. SAFE AND SECURE STORAGE OF YOUR FIREARM IS ONE OF THE MOST IMPORTANT RULES OF FIREARM SAFETY. YOUR FAILURE TO FOLLOW THESE RULES MAY RESULT IN SERIOUS INJURY OR DEATH TO YOU OR OTHERS.

- **ALWAYS SECURE YOUR FIREARM IN A MANNER THAT WILL PREVENT UNAUTHORIZED ACCESS.** Whenever your firearm is not in use, keep it unloaded and locked. Your safety and the safety of others requires that you always secure and store your firearm in a manner that will prevent unauthorized access. Never leave a firearm unattended unless it is locked, unloaded and secured.
- **ALWAYS USE THE LOCK PROVIDED BY THOMPSON/CENTER TO SECURE YOUR FIREARM.** Please read and follow the instructions packaged separately for the use of this lock. A lock, when properly used, can be an effective tool in preventing unauthorized access to your firearm. There are other alternative locks and safe storage containers available in the marketplace which may also be appropriate for your particular needs. Consult your local gun shop, hardware store, or local police department for guidance on the variety of other safe storage devices or practices which may be appropriate for your particular needs. By purchasing this firearm you have accepted the responsibility of safely securing the firearm at all times and preventing its unauthorized use. Never assume that the use of this lock alone is sufficient to safely secure your firearm. It is your personal responsibility to select and use whatever measures or practices that will enable you to be absolutely certain that your firearm is secure at all times.



WARNING: NEVER LOCK A LOADED FIREARM AND NEVER LOAD A LOCKED FIREARM!!

SAFE STORAGE & TRANSPORTATION CONTINUED

- **ALWAYS STORE YOUR FIREARM AND AMMUNITION SEPARATELY** so that they are not accessible to children or other unauthorized persons. Safe and secure storage of your firearm and ammunition are your responsibility. It is a full-time responsibility.
- **NEVER ASSUME THAT A “HIDING” PLACE IS A SECURE STORAGE METHOD.** Others may be aware of your storage location or come upon it by chance. It is your personal responsibility to use common sense when storing your firearm and ammunition and to always make sure they are not accessible to children or other unauthorized persons.
- **NEVER TRANSPORT A LOADED FIREARM.** When transporting your firearm, be sure it is unloaded and locked. Safe and secure transportation of your firearm is your responsibility.
- **ALWAYS FOLLOW THE LAW!** Many jurisdictions have laws that make it a crime to keep a firearm unlocked and in an area accessible to children or others. Keeping a firearm locked and unloaded when not in use is not only common sense safety practice... IT IS THE LAW. You must be familiar with all local, state, and federal laws regarding the safe storage and transportation of your firearm. Failure to know and follow the law may result in unauthorized access or use of your firearm by another. Obey all laws relating to the storage and transportation of firearms. Your local police department or gun shop can furnish you with available information on storing and/or transporting a firearm safely and legally.
- **YOUR FIREARM IS YOUR RESPONSIBILITY.** You must prevent your firearm from being stolen or from being used by untrained or unqualified individuals. Keep it locked, unloaded and secured when not in use.
- Use the lock provided to prevent unauthorized use, follow the instructions supplied with the lock.
- Never leave the key with the stored firearm.

PREPARATION FOR FIRING



WARNING: FAILURE TO FOLLOW THESE FIREARM SAFETY REQUIREMENTS WILL CAUSE SERIOUS PERSONAL INJURY OR DEATH TO YOU OR OTHERS.

- **ALWAYS TREAT ALL FIREARMS AS IF THEY ARE LOADED AND WILL FIRE IF THE TRIGGER IS PULLED.**
- **ALWAYS BE SURE THAT THE ACTION OF THE DIMENSION® IS OPEN, THAT THE CHAMBER IS CLEAR OF A CARTRIDGE AND THAT THE DIMENSION® IS POINTING IN A SAFE DIRECTION.**
- **ALWAYS WEAR ADEQUATE AND PROPER HEARING PROTECTORS SPECIFIED FOR FIREARM USE** to prevent permanent damage to your hearing. Make sure others who are nearby are wearing hearing protection as well.
- **ALWAYS WEAR SAFETY GLASSES SPECIFIED FOR FIREARM USE**, whether indoors or out. Safety glasses should protect your eyes from the firing flash and particles associated with the discharge of ammunition. Failure to do so creates a risk of personal injury from particle or debris spitting or ricochets.
- **ALWAYS BE ALERT AND ALWAYS FOLLOW THE SAFETY INSTRUCTIONS OF THE RANGE OFFICER.** Never shoot if you are tired, cold or impaired in any way.
- **ALWAYS BE AWARE OF OTHER PEOPLE** so that persons do not accidentally walk into the line of fire.
- **THE SHOOTER (AND ALL OTHERS IN THE SHOOTING AREA) MUST ALWAYS BE IN A POSITION THAT IS OUT OF THE LINE OF FIRE** and are not within an area where they may be struck by a ricochet or particles spitting from a firearm, or by ejected cases from some types of firearms.
- **NEVER SHOOT AT SURFACES THAT MAY CAUSE A RICOCHET.** Always select a place to shoot that has a safe backstop, is free from obstructions and has no surfaces which may cause a ricochet.
- **NEVER FIRE RANDOMLY INTO THE SKY.** Always select a place to shoot that has a safe backstop.
- **NEVER USE ALCOHOL OR DRUGS BEFORE OR WHILE SHOOTING OR HANDLING ANY FIREARM.**

AMMUNITION



WARNING: NEVER USE AMMUNITION NOT SPECIFICALLY DESIGNATED FOR USE IN YOUR FIREARM. FAILURE TO USE THE CORRECT TYPE OR CALIBER OF AMMUNITION MAY CAUSE THE FIREARM TO JAM, OR FAIL TO FIRE, OR MAY GENERATE EXCESSIVE PRESSURE WHICH CAN DAMAGE OR EVEN RUPTURE YOUR FIREARM, CAUSING PERSONAL INJURY OR DEATH TO THE SHOOTER OR BYSTANDERS.

- Locate the cartridge designation marked on the barrel. This information indicates the correct ammunition that must be used in this firearm (FIGURE 1).

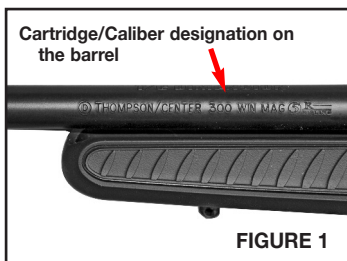

- You are responsible for selecting ammunition that meets industry standards and is appropriate in type and caliber for this firearm.

- Never mix ammunition.



WARNING: IN SOME CASES, A ROUND OF AMMUNITION NOT SPECIFIED ON YOUR FIREARM AND NOT LISTED AS ALTERNATE AMMUNITION IN THIS MANUAL, MAY FIT INTO THE CHAMBER. FIRING THIS AMMUNITION MAY CAUSE A RUPTURE RESULTING IN DAMAGE TO THE FIREARM AND PERSONAL INJURY OR DEATH TO THE SHOOTER OR BYSTANDERS. FOR MORE INFORMATION REGARDING UNSAFE CALIBER COMBINATIONS, REFER TO THE FOLLOWING URL: [HTTP://WWW.SAAMI.ORG/SPECIFICATIONS_AND_INFORMATION/PUBLICATIONS/DOWNLOAD/SAAMI_ITEM_211-UNSAFE_ARMS_AND_AMMUNITION_COMBINATIONS.PDF](http://www.saami.org/specifications_and_information/publications/download/saami_item_211-unsafe_arms_and_ammunition_combinations.pdf)



WARNING: ALWAYS INSPECT YOUR AMMUNITION BEFORE USING IT. NEVER USE DIRTY, CORRODED OR DAMAGED AMMUNITION. A BURST CARTRIDGE MAY RESULT CAUSING DAMAGE TO THE FIREARM AND PERSONAL INJURY OR DEATH TO THE SHOOTER OR BYSTANDERS.

- Use only commercially manufactured ammunition with internal ballistic pressures which are in strict accordance with the specifications of the Sporting Arms and Ammunition Manufacturers' Institute (SAAMI). If you are uncertain, contact your ammunition supplier for verification.

AMMUNITION CONTINUED



WARNING: NEVER USE NON-STANDARD, RELOADED OR "HANDLOADED" AMMUNITION WHICH HAS NOT BEEN SUBJECTED TO INTERNAL BALLISTIC PRESSURE TESTING. RELOADED OR HANDLOADED AMMUNITION, MAY HAVE MANY MANUFACTURING AND QUALITY VARIABLES (SUCH AS THE TYPE AND AMOUNT OF GUN POWDER). CARTRIDGE CASES THAT HAVE BEEN RELOADED AND FIRED MULTIPLE TIMES MAY SUFFER PHYSICAL DAMAGE WHICH COULD SIGNIFICANTLY IMPACT OR REDUCE THE INTEGRITY OF THE CARTRIDGE, POSSIBLY RESULTING IN BULLET SETBACK OR UNSEATING. CASE FAILURE AND INJURY TO THE SHOOTER OR BYSTANDERS AND DAMAGE TO THE FIREARM MAY RESULT WHEN SUCH A ROUND IS FIRED. ANY AMMUNITION THAT IS IMPROPERLY MANUFACTURED OR RELOADED, EVEN IN THE SLIGHTEST DEGREE, MAY FAIL TO FIRE OR MAY GENERATE EXCESSIVE INTERNAL PRESSURES WHICH CAN DAMAGE OR EVEN RUPTURE THE FIREARM, CAUSING PERSONAL INJURY OR DEATH TO THE SHOOTER OR THOSE IN THE IMMEDIATE VICINITY.

- A firearm and ammunition are a system and must work together. There are different types of ammunition for different types of firearms. Your firearm has been designed for ammunition of a specific type and a specific gauge or caliber. It is important to select the proper ammunition for your firearm.
- Different combinations of bullet velocity, bullet weight and firearm weight can have major impact on felt recoil; a high level of felt recoil can be uncomfortable to some shooters.



WARNING: NEVER USE CARTRIDGES OR SHELLS OTHER THAN THOSE DESIGNATED BY THE MARKING ON THE BARREL. DOING SO CAN RESULT IN DANGEROUSLY HIGH PRESSURES THAT MAY DAMAGE THE FIREARM AND POSSIBLY CAUSE SERIOUS INJURY TO YOURSELF AND OTHERS.



WARNING: DEATH, SERIOUS INJURY AND PROPERTY DAMAGE CAN RESULT FROM THE USE OF INCORRECT AMMUNITION OR BORE OBSTRUCTIONS. NEVER USE RELOADED AMMUNITION THAT HAS NOT BEEN SUBJECTED TO INTERNAL BALLISTIC PRESSURE TESTING.



WARNING: DISCHARGING FIREARMS IN POORLY VENTILATED AREAS, CLEANING FIREARMS, OR HANDLING AMMUNITION MAY RESULT IN EXPOSURE TO LEAD AND OTHER SUBSTANCES KNOWN TO CAUSE BIRTH DEFECTS, REPRODUCTIVE HARM, AND OTHER SERIOUS PHYSICAL INJURY. HAVE ADEQUATE VENTILATION AT ALL TIMES. WASH HANDS THOROUGHLY AFTER EXPOSURE.

MODEL AND FEATURES IDENTIFICATION

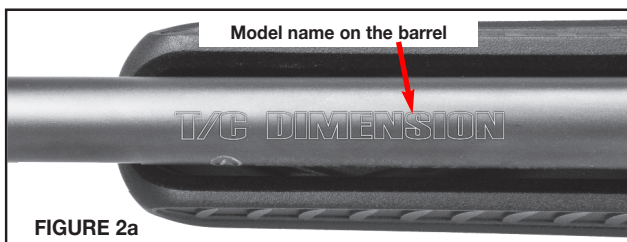
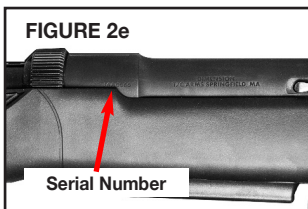
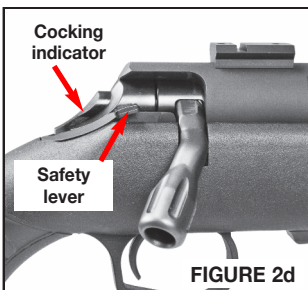
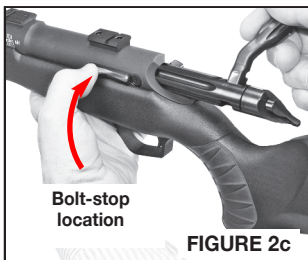
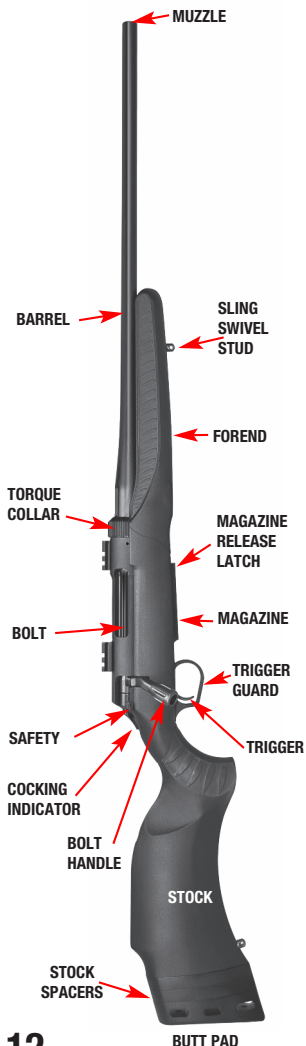

FIGURE 2b



INSPECTION AND INITIAL ASSEMBLY



WARNING: ALWAYS ENSURE THAT THE FIREARM IS UNLOADED BEFORE INSPECTING, DISASSEMBLING, ASSEMBLING OR CLEANING AND ALWAYS KEEP THE MUZZLE POINTED IN A SAFE DIRECTION.

- Your Thompson/Center Dimension® rifle comes completely assembled from the factory except for the bolt, which has been removed for transportation and storage. The bolt is packed separately in the shipping carton.

INSPECT

- Grasp the rifle, keeping your finger outside the trigger guard and off the trigger. Point the muzzle in a safe direction.
- If the bolt has not been installed yet, verify that the chamber is empty.
- If the bolt has been installed, lift the bolt handle and pull the bolt open to check that the chamber is empty (FIGURE 3).
- Ensure that the magazine is empty (FIGURE 4).
- Press the magazine latch rearward to release the magazine (FIGURE 5).
- Orient the rifle as shown to allow the magazine to drop out of the rifle when the magazine latch is released (FIGURE 6). Catch the magazine as it falls clear of the rifle.

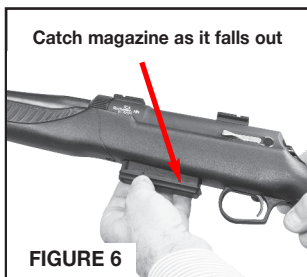
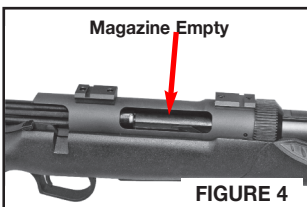
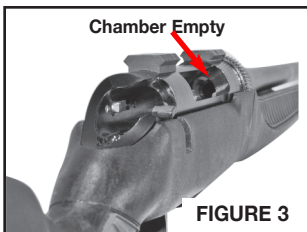

INSPECTION AND INITIAL ASSEMBLY CONTINUED

INSTALLING THE BOLT

- Grasp the bolt by its handle and slide the bolt forward into the receiver as shown (FIGURE 7). Note that the bolt handle touches the stock.

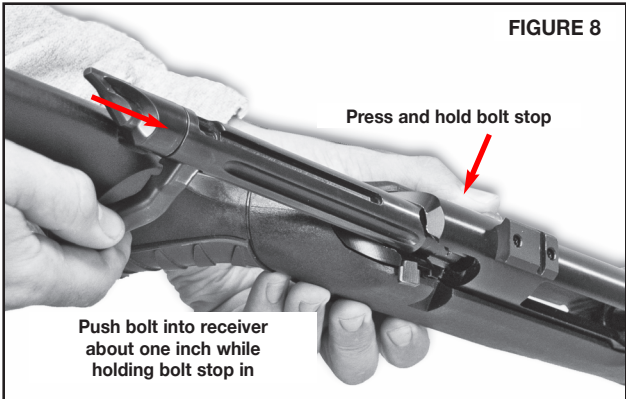
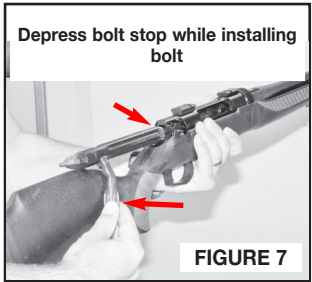

- While pressing the bolt stop in, continue to push the bolt forward into the receiver about one inch (FIGURE 8).

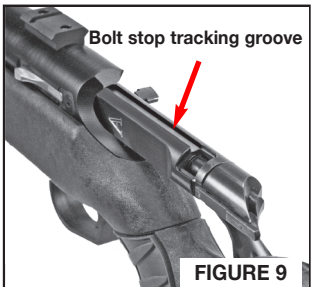

- FIGURE 9 shows the bolt stop tracking groove, to distinguish it from the bolt flutes.

- While continuing to press the bolt stop in (so it doesn't get caught in the bolt flutes) rotate the bolt handle until the bolt stop engages the bolt stop track (FIGURE 10).

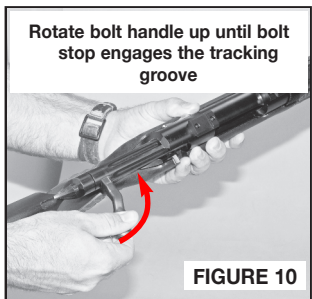

INSPECTION AND INITIAL ASSEMBLY CONTINUED

- Push the bolt fully forward into the receiver once the bolt engages the bolt stop track and the handle is in this position (FIGURE 11).
- Close the bolt fully by pushing it fully forward and then turning the bolt handle down (FIGURE 12).
- Before using your firearm for the first time, it should be cleaned.

THE SAFETY LEVER

- For right-hand models it is located on the right side at the rear of the receiver, it has two positions that are set by the user:
- For left-hand models it is located on the left side at the rear of the receiver, it has two positions that are set by the user:
- Fully rearward - In the "SAFE" position (FIGURE 13).
- Fully forward in the - "FIRE" position (FIGURE 14) where the red dot on the stock is now visible and the firearm can be fired by pulling rearward on the trigger.

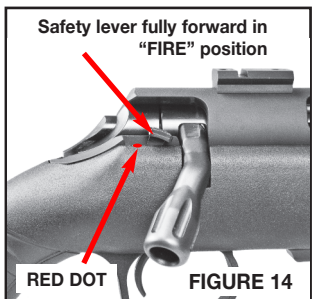
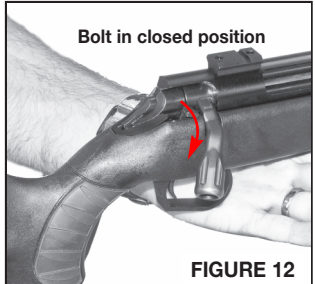
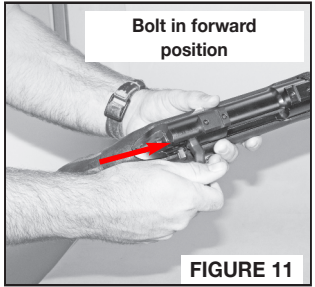

 **WARNING: NEVER RELY ON MECHANICAL FEATURES ALONE. ONLY YOUR SAFE FIREARM HANDLING WILL ENSURE THE SAFE USE OF YOUR FIREARM. THIS IS YOUR RESPONSIBILITY.**

 **WARNING: NEVER MODIFY ANY OF THE PARTS IN YOUR FIREARM. DO NOT ADD OR REPLACE ANY OF THE PARTS IN YOUR FIREARM UNLESS THEY ARE GENUINE THOMPSON/CENTER PARTS AND YOU FOLLOW THE INSTRUCTIONS SUPPLIED BY THOMPSON/CENTER. IF YOU DO OTHERWISE, IMPROPER FUNCTIONING MAY OCCUR AND SERIOUS INJURY OR DEATH MAY RESULT.**

LOADING



WARNING: ALWAYS KEEP THE MUZZLE POINTED IN A SAFE DIRECTION.

- Open the bolt and inspect the rifle's bore for obstructions (and clean if necessary) (FIGURE 15).
- Keep your finger outside the trigger guard and off the trigger. Point the muzzle in a safe direction.
- Do not load the rifle until you have read and fully understand this manual.
- Do not load the rifle until you are ready to use it.
- Never load your rifle until you are sure of your target, what is beyond it and are fully prepared to fire.

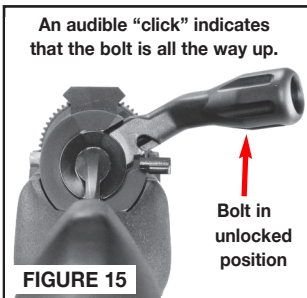

- Place the safety lever in the "SAFE" position (FIGURE 16).
- Remove the magazine from the rifle in order to load the cartridges into it. Insert the cartridges into the magazine as shown (FIGURE 17).



- Just prior to firing, open the bolt fully and then insert the loaded magazine and "snap" it into place, tipping the back in first and then lifting the front until it "clicks" into locked position (FIGURE 18).

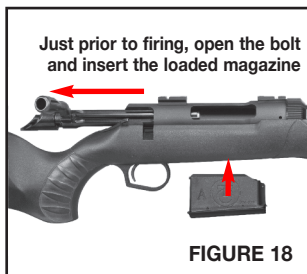

WARNING: NEVER CARRY THIS RIFLE WITH A CARTRIDGE IN THE CHAMBER. FAILURE TO FOLLOW THIS INSTRUCTION CAN LEAD TO PERSONAL INJURY OR DEATH TO YOU OR OTHERS.

FIRING



WARNING: ALWAYS KEEP THE MUZZLE POINTED IN A SAFE DIRECTION.



WARNING: WEAR EYE AND HEARING PROTECTION SPECIFIED FOR FIREARM USE EVERY TIME YOU DISCHARGE YOUR FIREARM. MAKE SURE OTHERS IN THE VICINITY OF WHERE YOU WILL BE SHOOTING DO SO AS WELL.

- Make certain that the safety is in the “SAFE” position (FIGURE 19).
- Close the bolt to strip a round from the magazine and put it into the chamber.
- Grasp firearm with one hand on the fore-end and other hand on the grip with the trigger finger resting along and outside of the trigger guard. Raise firearm and pull buttstock firmly into shoulder. Aim at your target.

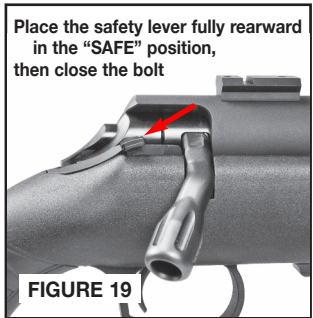

- Push the safety lever to the fully forward “FIRE” position (FIGURE 20).
- The rifle will now fire when pressure is applied to the trigger.
- Place your finger on trigger and squeeze it until the rifle fires.
- You may continue to fire by fully cycling the bolt and squeezing the trigger until the rifle is empty.

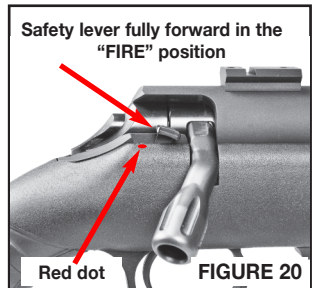

- To reload, see the **Loading Section**.

CLEARING MISFIRES



WARNING: ALWAYS KEEP THE MUZZLE POINTED IN A SAFE DIRECTION.



WARNING: IF YOUR FIREARM GIVES ANY INDICATION THAT IT IS NOT PERFORMING PROPERLY OR THE OPERATION OF YOUR FIREARM HAS CHANGED “THE WAY IT FEELS OR SOUNDS,” STOP FIRING. MAKE SURE THE FIREARM IS POINTED IN A SAFE DIRECTION, UNLOAD THE FIREARM AND HAVE IT INSPECTED BY A FACTORY TECHNICIAN. CALL THOMPSON/CENTER CUSTOMER SUPPORT.

- If a cartridge fails to fire, keep the muzzle pointed in a safe direction and wait 10 seconds before opening the bolt and ejecting the suspect cartridge. Then remove the magazine and make sure that the rifle is unloaded.

UNLOADING



WARNING: ALWAYS KEEP THE MUZZLE POINTED IN A SAFE DIRECTION.

- Open the bolt and ensure that the chamber is empty (FIGURE 21).

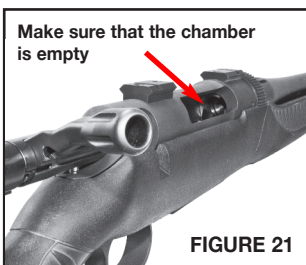

- Set safety lever to the “SAFE” position (FIGURE 22).



- Press the magazine latch rearward and remove the magazine (FIGURES 23 & 24).



DISASSEMBLY / FIELD STRIPPING



WARNING: ALWAYS KEEP THE MUZZLE POINTED IN A SAFE DIRECTION.



WARNING: NEVER DO ANYTHING BEYOND WHAT YOU ARE SPECIFICALLY INSTRUCTED TO DO IN THIS MANUAL. NEVER ALTER OR MODIFY THE PARTS IN YOUR FIREARM.



WARNING: WEAR SAFETY GLASSES EVERY TIME YOU ASSEMBLE OR DISASSEMBLE YOUR FIREARM.



WARNING: DO NOT ALTER, MODIFY OR REPLACE ANY OF THE PARTS OF YOUR FIREARM UNLESS THIS WORK IS PERFORMED BY A QUALIFIED GUNSMITH USING GENUINE THOMPSON/CENTER PARTS. IF YOU DO OTHERWISE, IMPROPER FUNCTIONING MAY OCCUR AND SERIOUS INJURY MAY RESULT.

FIELD STRIPPING FOR THE PURPOSE OF CLEANING

- Lift the bolt handle and draw the bolt fully to the rear.
- Place the safety lever in the “SAFE” position.
- Check through the ejection port to confirm that the chamber and magazine are both empty.
- Remove the magazine from the rifle.
- At this point, press the bolt stop in as shown (FIGURE 25).

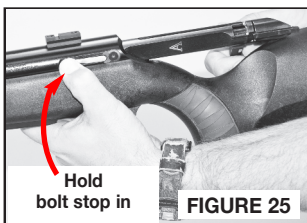

- Continue to hold the bolt stop depressed while you rotate the bolt as shown (FIGURE 26) and continue to pull the bolt from the receiver rearward (FIGURE 27) taking care not to hit the stock, causing cosmetic damage.

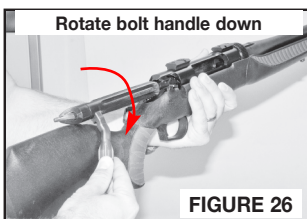

- This is the extent to which the rifle needs to be disassembled for the purpose of cleaning and maintenance. See the section in this manual for cleaning instructions.

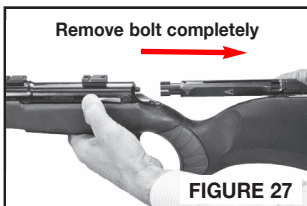

MOUNTING A SCOPE



WARNING: ALWAYS ENSURE THAT THE FIREARM IS UNLOADED BEFORE INSTALLING A SCOPE OR ANY OTHER ACCESSORIES. FAILURE TO DO THIS CAN CAUSE PERSONAL INJURY OR DEATH TO YOU OR OTHERS.

- We recommend that you have a competent gunsmith install your scope and mount.
- The T/C Dimension® is factory equipped with Weaver-style scope mount bases. These bases accept a ring and scope combination of your choice. Different scopes have varying lengths of recommended eye relief. You need to choose a combination that allows for adequate clearance between the scope and your eyebrow. Follow the instructions supplied with the scope and rings for proper installation (FIGURE 28).



WARNING: A SCOPE WHICH IS NOT SECURELY MOUNTED MAY BECOME DETACHED UPON RECOIL OF THE FIREARM. IF IT BECOMES DETACHED IT MAY FLY BACK AND STRIKE THE SHOOTER OR A BYSTANDER AND CAUSE INJURY. OBSERVE THE CONDITION OF ALL THE SCOPE MOUNT SCREWS AFTER FIRING. IF THE MOUNTING SCREWS SHOW SIGNS OF LOOSENING DO NOT FIRE THE FIREARM AGAIN; TAKE IT TO A QUALIFIED GUNSMITH FOR ASSISTANCE.



WARNING: FIRING A SCOPED FIREARM WITH YOUR EYE TOO CLOSE TO THE SCOPE EYE PIECE, OR FAILING TO HOLD THE FIREARM SECURELY AGAINST RECOIL, MAY RESULT IN SERIOUS PERSONAL INJURY INCLUDING, BUT NOT LIMITED TO, BLINDNESS.

SCOPE MOUNT CONTINUED

- A LOC™ bridge-type scope mount base is offered as an accessory (FIGURE 29). The advantage of the bridge-type system is that the “sighted-in” scope stays with the barrel when the barrel is changed out for another barrel. The one rear cross-bolt ties the base rigidly to the receiver. This one bolt needs to be removed to allow the barrel to be removed from the receiver. See section in this manual for details on the bridge-type scope mount base system. T/C suggests using low rings with the LOC™ bridge-type mount to provide proper eye relief.

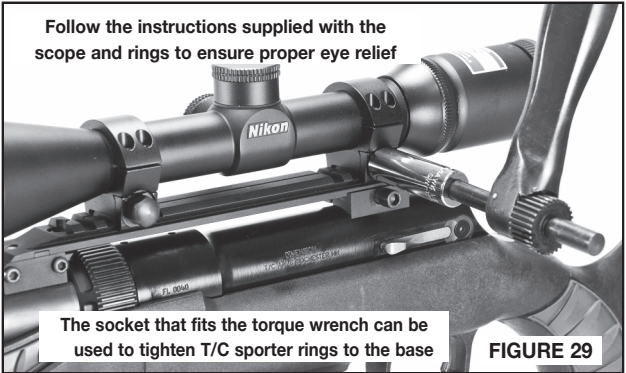

MAKING TRIGGER ADJUSTMENTS



WARNING: ALWAYS ENSURE THAT THE FIREARM IS UNLOADED BEFORE ADJUSTING THE TRIGGER OR DRY FIRING.

NOTE: The T/C Dimension® trigger pull is user adjustable for weight of pull. The trigger pull has been set at the factory with proper over-travel and sear engagement.

- After determining that the firearm is unloaded proceed as follows:
- Trigger “Weight of Pull” adjustment can be made by first removing the bolt from the receiver to gain access to the adjustment screw (FIGURE 30). The appropriate tool is included in the box from the factory (FIGURE 31).

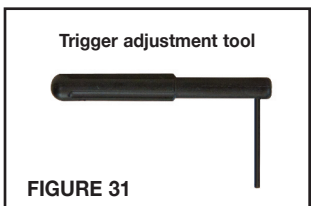
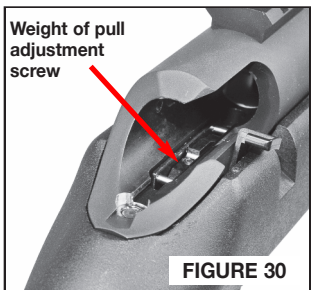

MAKING TRIGGER ADJUSTMENTS CONTINUED

- Turn the screw clockwise (as viewed from the top of the rifle) to increase the trigger pull force required. A trigger adjustment tool is provided with the T/C Dimension® rifle (FIGURE 29).
- Turn the adjustment screw counter-clockwise to decrease the trigger pull force required.
- After each adjustment, with the chamber empty and the rifle pointed in a safe direction, dry fire the rifle until the desired pull is achieved.
- Do not attempt any other trigger adjustments. When turning the adjustment screw, once resistance is met, do not force the screw to turn further in either direction.

DRY FIRING NOTE

- Be certain that the chamber is unloaded and the magazine is removed from the rifle. Keep the firearm pointed in a safe direction. The Thompson/Center Dimension® rifle can be dry fired without damage to the firing pin or other components. To dry fire, cock the rifle by lifting the bolt handle fully and returning it to the closed position and then pulling the trigger.

NOTE REGARDING DIMENSION® STOCK FINISH AND CLEANING:

To help preserve the ARMORSOFT® coating on your Thompson/Center Arms Dimension® rifle stock, remove the stock from the barreled receiver when using solvents to clean the bore.

CAUTION: Do not allow the following chemicals to come in contact with the ARMORSOFT® coating: Gun Scrubber®, T17® Foaming Bore Cleaner, acetone or any DEET-based insecticide or repellent. Damage to the finish will result.

If you have further questions, please call our Customer Service Department at 1-866-730-1614.

CLEANING AND MAINTENANCE



WARNING: ENSURE THAT YOUR FIREARM IS UNLOADED BEFORE BEGINNING TO CLEAN IT. (SEE “INSPECTING YOUR FIREARM” SECTION). ALWAYS FOLLOW THE FUNDAMENTAL NRA RULES OF SAFE FIREARM HANDLING.



WARNING: WEAR EYE PROTECTION SPECIFIED FOR FIREARM USE EVERY TIME YOU CLEAN OR MAINTAIN YOUR FIREARM.

- Before using your firearm for the first time, it should be cleaned.
- Your firearm was treated at the factory with either a preservative or oil to protect it against corrosion during shipping and storage.
- Preservative and oil should be wiped from the bore, chamber and exposed areas using a clean swab or patch before using the firearm.

CAUTION: Never disassemble your firearm beyond the instructions in the Field Stripping and Inspection sections of this manual.

- Purchase cleaning supplies from your firearms dealer that are specifically designated for your type and caliber of firearm. Many suppliers offer these in kit form for your convenience.
- Follow the instructions provided with your cleaning supplies.

NOTE: A basic firearm cleaning kit should include: a brass bore brush and a cleaning jag of appropriate size for the bore being cleaned, high-quality gun cleaning solvent and gun oil/lubricant, cotton cleaning patches and a cleaning rod that is long enough to push the brush and jag completely through the barrel.

- Remove excessive firing residue from the bore and chamber using a properly fitted brush.
- Clean the exterior of the firearm using a non-abrasive cleaning cloth.
- After cleaning, lightly coat the metal parts, internal and external with a firearm oil.
- Whenever your firearm has been exposed to sand, dust, extreme humidity, water or other adverse conditions, it must be cleaned and lubricated.



WARNING: ALWAYS HAVE ADEQUATE VENTILATION. CLEANING FIREARMS IN POORLY VENTILATED AREAS, DISCHARGING FIREARMS, OR HANDLING AMMUNITION MAY RESULT IN EXPOSURE TO LEAD AND OTHER SUBSTANCES KNOWN TO CAUSE BIRTH DEFECTS, REPRODUCTIVE HARM AND OTHER SERIOUS PHYSICAL INJURY. WASH HANDS THOROUGHLY AFTER EXPOSURE.

CLEANING AND MAINTENANCE CONTINUED

- Run a few patches saturated with good quality firearm cleaning solvent through the bore, preferably from the chamber end to avoid damage to the rifling at the muzzle. Use of a bronze bore brush may be required periodically. More extensive cleaning, especially after the T/C Dimension® has been subjected to rain or snow, would include wiping all of the external metal surfaces with a dry cloth, followed by a light coating of oil. If the internal components require cleaning, it is recommended that you return the firearm to Thompson/Center's Service Department.

CAUTION: Always follow the instructions provided with your firearm cleaner and firearm lubricant.

CAUTION: Some cleaners can cause damage to your firearms. You should avoid prolonged solvent immersion and prolonged ultrasonic cleaning of your firearm. Choice of solvent should be restricted to those products specifically developed for firearms maintenance. Damage to a firearm's finish may occur if these cautions are ignored. Ammoniated solvents or other strong alkaline solvents, should not be used on any Thompson/Center firearm.

 **WARNING: NEVER MANIPULATE, ADJUST OR CHANGE ANY OF THE INTERNAL COMPONENTS OF YOUR FIREARM UNLESS SPECIFICALLY DIRECTED TO DO SO IN THIS MANUAL. IMPROPER MANIPULATION OF ANY INTERNAL COMPONENT MAY AFFECT THE SAFETY AND RELIABILITY OF YOUR FIREARM AND MAY CAUSE SERIOUS INJURY OR DEATH. IT ALSO VOIDS YOUR WARRANTY.**

 **WARNING: ANY MAINTENANCE, ADJUSTMENT OR SERVICE NOT SPECIFIED IN THIS MANUAL MAY AFFECT THE SAFETY AND RELIABILITY OF YOUR FIREARM AND MUST BE PERFORMED BY A QUALIFIED GUNSMITH USING GENUINE THOMPSON/CENTER PARTS. IF YOU DO OTHERWISE, IMPROPER FUNCTIONING OF YOUR FIREARM MAY OCCUR AND SERIOUS INJURY OR DEATH MAY RESULT.**

- If your firearm will be used in a cold climate, be sure to use an oil of an appropriate weight so that it will not congeal in cold temperatures, causing the interaction of important parts to be slowed or halted.

MAINTENANCE BEFORE STORAGE

- When storing, do not encase your firearm in anything that will attract or hold moisture, for example, leather or heavy cloth. Also, do not store guns with a plug inserted in the barrel for this can be a contributing factor to moisture accumulation. If your firearm is to be stored for an extended period, the bore, chamber and internal surfaces should be oiled with a high-quality lubricating oil or preservative intended for firearms. The external parts; receiver, bolt and barrel should be coated with an anti-rust oil. Before using your firearm again, be sure to clean it. Every time you clean your firearm, check it for signs of wear. If wear is noted, do not use the firearm. Return it to Thompson/Center for service or have it checked by a qualified gunsmith.

CONVERSION PARTS

- The T/C Dimension® is a modular design. Each of the four (4) interchangeable parts will have a letter marking that indicates that it is to be used with similarly marked parts (FIGURES 32-35).

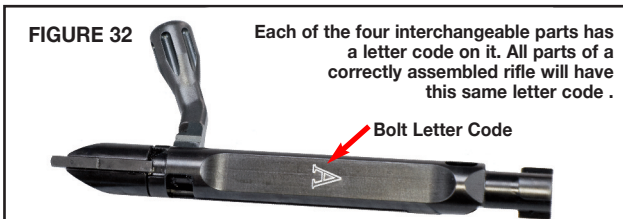

WARNING: ALWAYS ENSURE THAT THE FIREARM IS ASSEMBLED USING PARTS WITH THE SAME LETTER CODE MARKINGS ON THE INTERCHANGEABLE PARTS. A MIX OF LETTER CODES COULD RESULT IN A DANGEROUS COMBINATION, POSSIBLY RESULTING IN INJURY AND/OR DEATH TO THE SHOOTER OR BYSTANDERS AND DAMAGE TO PROPERTY.

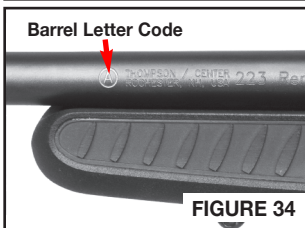
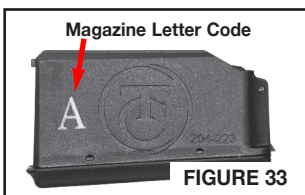

- The stock and receiver are the same for all calibers. The letter codes designate “families” of cartridges that share common lengths and case dimensions. These common sizes allow them to function correctly in the rifle with appropriately marked parts.

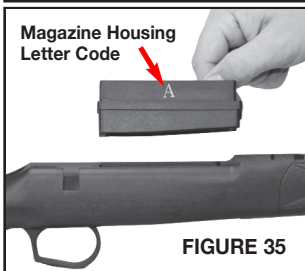

WARNING: NEVER USE AMMUNITION NOT SPECIFICALLY DESIGNATED FOR USE IN YOUR FIREARM. FAILURE TO USE THE CORRECT TYPE OR CALIBER OF AMMUNITION MAY CAUSE THE FIREARM TO JAM, FAIL TO FIRE OR EVEN GENERATE EXCESSIVE PRESSURE WHICH CAN DAMAGE OR EVEN RUPTURE YOUR FIREARM, CAUSING PERSONAL INJURY, DEATH OR PROPERTY DAMAGE.

- The cartridge/caliber marking on the barrel must be strictly adhered to. The marking on the barrel is specific to one cartridge and that is the only one that should be used in that barrel.

CONVERSION PARTS CONTINUED

- FIGURE 36 shows the uses of the various parts of the T/C Dimension rifle LOC™ Hand Tools.

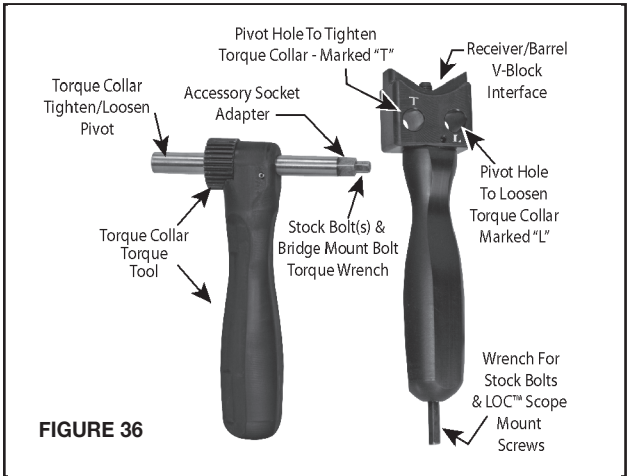

WARNING: DO NOT ADD OR REPLACE ANY OF THE PARTS IN YOUR FIREARM UNLESS THEY ARE GENUINE THOMPSON/CENTER PARTS AND YOU FOLLOW THE INSTRUCTIONS SUPPLIED. IF YOU DO OTHERWISE, IMPROPER FUNCTIONING MAY OCCUR AND SERIOUS INJURY OR DEATH MAY RESULT. IN ADDITION TO THE DANGERS PRESENTED, THE USE OF NON-FACTORY PARTS, INCLUDING BUT NOT LIMITED TO BARRELS AND SPRINGS, VOIDS ALL WARRANTIES.

NOTE: The magazine for the T/C Dimension® 22-250 Rem. is listed as a part of the "B" family of interchangeable components. The steep shoulder of the cartridge dictates that a slight change to the standard "B" series mold be made to ensure reliable cartridge feeding from the magazine into the chamber. The magazine is marked with a "B" and the 22-250 Rem reference for clarity.

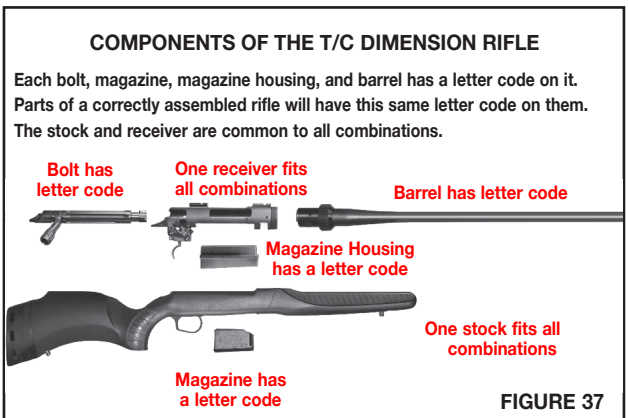

CHANGING A BARREL



WARNING: ALWAYS KEEP THE MUZZLE POINTED IN A SAFE DIRECTION.



WARNING: ALWAYS ENSURE THAT THE FIREARM IS UNLOADED BEFORE INSPECTING, PERFORMING ADJUSTMENTS OR MAINTENANCE, ASSEMBLING OR DISASSEMBLING.

CAUTION: THE USE OF TOOLS TO CHANGE PARTS ON YOUR T/C DIMENSION COMES WITH THE RISK OF BEING PINCHED AS PARTS COME TOGETHER. BE CAREFUL WHEN USING TOOLS TO PREVENT THIS POTENTIAL PROBLEM.

NOTE: The modular nature of the T/C Dimension® design allows easy interchanging of barrels, bolts, stocks and scope mounts. Each piece of the correct combination of four (4) interchangeable parts will have a letter marking (A,B,C,D, etc.) that indicates that it is to be used with components with the same mark.

TO REMOVE A BARREL

NOTE: The high comb of the stock prevents the bolt from coming straight out rearward. The bolt handle must be tipped down to provide clearance in disassembly.

Step 1: Open the bolt and draw it fully rearward. Depress and hold the bolt stop in and remove the bolt from the receiver. (FIGS. 38 & 39).

NOTE: The bolt handle must be rotated down until the bolt handle touches the stock when withdrawing it. Cosmetic damage to the stock may result if the bolt isn't rotated before it is withdrawn.

Step 2: Unlatch and remove the magazine from the rifle (FIGURES 40 & 41).

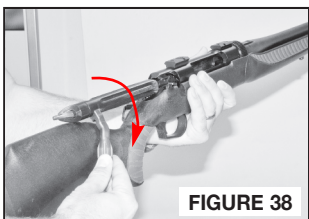

CHANGING A BARREL CONTINUED

Step 3: Remove the stock from the barreled receiver. The take-down/assembly torque tool has a correctly sized Allen wrench for this task. There are two bolts that need to be removed, one in front of the magazine well and one behind the trigger guard (FIGURES 42 & 43). The stock assembly bolts are designed not to be completely removed from the stock. Loosen the bolts until the receiver comes free of the stock. Break these bolts free using the leverage provided by the torque wrench - then spin them out with the hex end of the Leverage Handle.

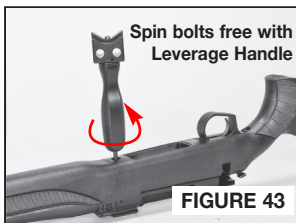
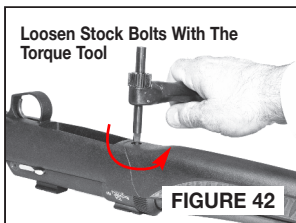

Step 4: Remove the magazine housing from the stock if you are switching to a different letter series of magazine (FIGURE 44). Install the replacement housing into the stock at this point as shown - making certain that the letter code matches that of the other parts being changed to.

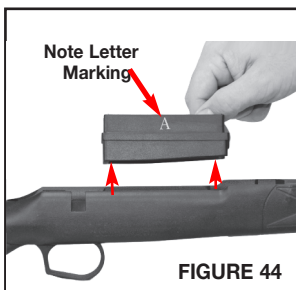

Step 5: Align and thread the Leverage handle into the receiver as shown (FIGURE 45) until the wrench is snug



- Insert the shaft of the gear drive on the torque wrench as shown into the hole marked "L" in the leverage handle (FIGURE 46) making sure that the gear teeth mesh fully before applying leverage.



CHANGING A BARREL CONTINUED

- Pull the handles of the tools together to loosen the Torque Collar (FIGURES 47 & 48).
- After initially loosening the barrel nut, remove the wrenches (by first loosening the Leverage Tool to relieve tension against the Torque Collar and finish unscrewing the Torque Collar by hand).
- Remove the barrel from the receiver.

NOTE: If a LOC™ bridge scope mount base is installed, the rear scope mount bolt must be removed and the Leverage Handle have to be removed because the barrel has to be pulled forward progressively as the Torque Collar is loosened, as the Torque Collar butts up against the LOC™ bridge mount as it is removed (see page 34 for details).



TO INSTALL A BARREL

- Locate the cartridge designation marked on the barrel. This information indicates the correct ammunition that must be used in this firearm. (FIG. 49).



Step 6: For barrels without a bridge-type scope mount:

Install new barrel onto receiver, taking care to align the locator pin in the slot of the receiver (FIGURES 50 & 51). Once the barrel extension is in place, carefully thread the barrel nut onto the receiver until it is snug.

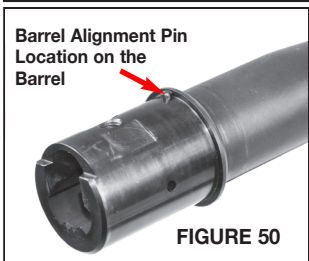

Step 6: For barrels with a bridge-type scope mount installed:

Slide the new barrel onto receiver until the barrel nut contacts the front of the receiver. Once the Torque Collar contacts the receiver the barrel nut must be threaded carefully onto the receiver until the barrel alignment pin engages the corresponding slot in the receiver (FIGURES 50 & 51).



CHANGING A BARREL CONTINUED

- Once the barrel is in the receiver with the locator pin aligned and the Torque Collar snugged down hand-tight, screw the Leverage Handle into place as shown (FIGURE 52).
- Once the Leverage Tool is screwed into position, insert the leverage handle into the Leverage Tool pivot hole marked "T" (FIGURE 53).

CAUTION: THE USE OF TOOLS TO CHANGE PARTS ON YOUR T/C DIMENSION COMES WITH THE RISK OF BEING PINCHED AS PARTS COME TOGETHER. BE CAREFUL WHEN USING TOOLS TO PREVENT THIS POTENTIAL PROBLEM.

- Pull the handles of the tools together until an audible "click" is heard. When the Torque Tool "clicks" the Torque Collar is tightened to the correct specification (FIGURE 54).
- Avoid getting pinched when bringing the handles together (FIGURE 55).
- After tightening the torque collar, remove the torque wrench (by first loosening the leverage handle to relieve tension against the torque collar).

Step 7: Be sure that you have installed the correct magazine housing into the stock for the letter series of caliber that you intend to use (FIGURE 56).

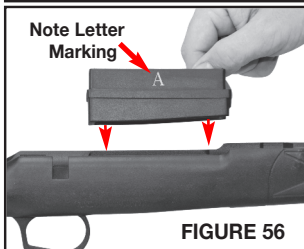
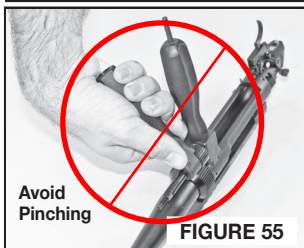
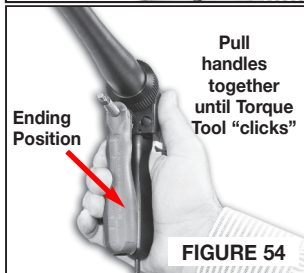
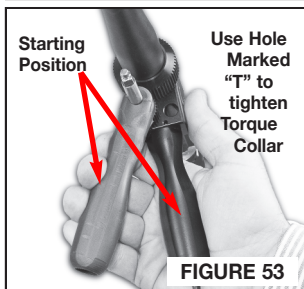

CHANGING A BARREL CONTINUED

Step 8: Reassemble barreled action into the stock. Use the Allen wrench end of the leverage handle to get the stock bolts “snug.” Once the bolts are snug, then use the Allen wrench at the end of the torque tool to torque the front bolt first. Turn the wrench clockwise (as viewed from the bottom) until it “clicks.” At this point the stock bolt is tightened correctly. Repeat the process with the rear stock bolt (FIGURES 57 through 59).

- Avoid getting pinched when the wrench “snaps” as the correct amount of torque is achieved (FIGURE 60).

CAUTION: THE USE OF TOOLS TO CHANGE PARTS ON YOUR T/C DIMENSION COMES WITH THE RISK OF BEING PINCHED AS PARTS COME TOGETHER. BE CAREFUL WHEN USING TOOLS TO PREVENT THIS POTENTIAL PROBLEM.

Step 9: Install the appropriately lettered bolt into receiver (FIGURE 61) making certain to match the rest of the conversion parts using the same letter code. Depress and hold the bolt stop in while installing the bolt.

- Push the bolt fully forward into the receiver once the bolt engages the bolt stop track and the handle is in this position (FIGURE 62).

- Close the bolt fully by pushing it fully forward and then turning the bolt handle down.

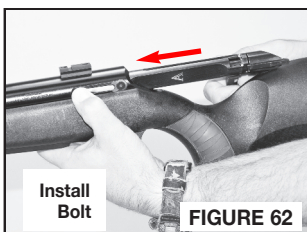
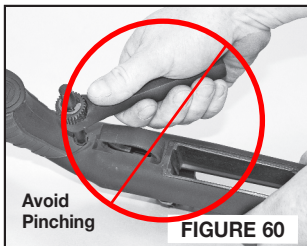
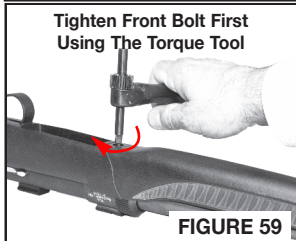
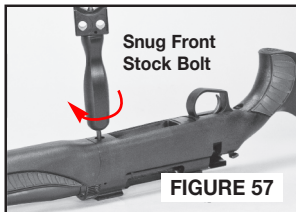

CHANGING A BARREL CONTINUED

Step 10: Insert the appropriately lettered magazine into position (FIGURE 63).



CHANGING A STOCK



WARNING: ALWAYS KEEP THE MUZZLE POINTED IN A SAFE DIRECTION.



WARNING: ALWAYS ENSURE THAT THE FIREARM IS UNLOADED BEFORE INSPECTING, PERFORMING ADJUSTMENTS OR MAINTENANCE, ASSEMBLING OR DISASSEMBLING.

NOTE: The modular nature of the T/C Dimension® design allows easy interchangeability of barrels, bolts, stocks and scope mounts. Each interchangeable piece of the correct combination of parts will have a letter marking that indicates that it is to be used with similarly marked components. The stock and the receiver are the same for all calibers.

- Open the bolt and ensure that the chamber is empty (FIGURE 64).
- Set safety lever to the “SAFE” position (FIGURE 65).
- Remove the magazine from the rifle (FIGURES 66 & 67).
- Loosen the two stock bolts (one behind the trigger guard and one in front of the magazine well) using the hex wrench end of the torque wrench tool (FIGURE 68).

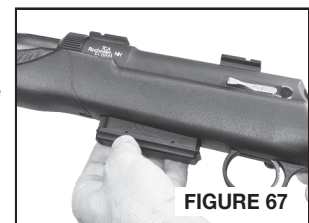

CHANGING A STOCK CONTINUED

NOTE: The stock bolts are designed to remain captive in the stock and do not come completely out.

- Once the stock bolts are fully loosened, the barrel/receiver assembly is free to be removed from the stock.
- In re-assembling a new combination of parts to match the task at hand, each piece of the correct combination of parts will have a letter marking that indicates that it is to be used with similarly marked components. The stock and the receiver are the same for all calibers. The bolt, magazine, magazine housing and barrel will be marked (A, B, C, D, etc).
- Make certain that the correct magazine housing (FIGURE 69) is present in the stock to match the magazine that the rifle is being converted to.

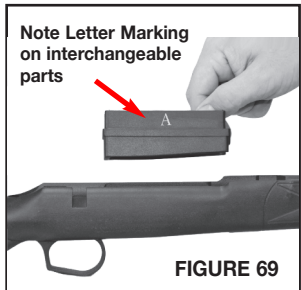
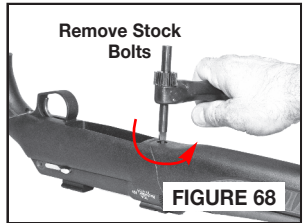

- Align the replacement stock with the bolt holes in the receiver and tighten the stock bolts using the torque wrench tool. The front bolt should always be tightened first. When the wrench “clicks” the correct torque has been applied to the stock bolts.

DIMENSION[®] STOCK SPACER

 **WARNING: ALWAYS KEEP THE MUZZLE POINTED IN A SAFE DIRECTION.**

 **WARNING: ALWAYS ENSURE THAT THE FIREARM IS UNLOADED BEFORE INSPECTING, PERFORMING ADJUSTMENTS OR MAINTENANCE, ASSEMBLING OR DISASSEMBLING.**

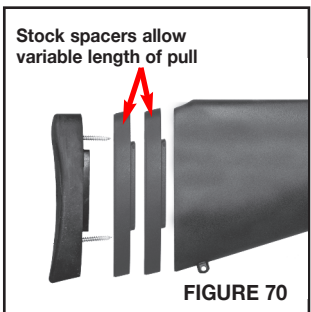

- The length of pull can be adjusted to help match the shooter’s needs by adding or removing the spacers at the end of the buttstock (FIGURE 70).

DIMENSION® STOCK SPACER CONTINUED

- The recoil pad is held in place with two phillips head screws. By removing these screws from the stock and adding or removing spacers, the length of the stock can be matched to the shooter's needs.
- The spacers are held in place by the same screws that hold the recoil pad onto the buttstock.

INSTALLING A LOC™ BRIDGE SCOPE MOUNT APPENDIX

(Mount is Sold Separately)



WARNING: ALWAYS KEEP YOUR FIREARM POINTED IN A SAFE DIRECTION. NEVER POINT A FIREARM AT ANYTHING YOU DO NOT INTEND TO SHOOT.



WE RECOMMEND THAT YOU HAVE A COMPETENT GUNSMITH INSTALL YOUR SCOPE & MOUNT.



NEVER ATTEMPT TO INSTALL A SCOPE MOUNT ON A LOADED FIREARM. ALWAYS ENSURE THAT THE FIREARM IS NOT LOADED.



A SCOPE WHICH IS NOT SECURELY MOUNTED MAY BECOME DETACHED UPON RECOIL OF THE FIREARM. IF IT BECOMES DETACHED IT MAY FLY BACK AND STRIKE THE SHOOTER OR A BYSTANDER AND CAUSE INJURY. OBSERVE THE CONDITION OF THE MOUNTING SCREWS AFTER FIRING. IF THE MOUNTING SCREWS SHOW SIGNS OF LOOSENING DO NOT FIRE THE GUN AGAIN; CALL THE CUSTOMER SERVICE DEPARTMENT FOR ASSISTANCE, TOLL FREE AT 866-730-1614.

- If you decide to install the bases yourself, the tools needed for this project are: A T-15 Torx Wrench (provided), a 1/8" Hex Wrench (provided), the 3/16" Hex end on the Torque Wrench (provided with rifle), a small screwdriver and low - strength LocTite® ThreadLocker (FIGURE 1).

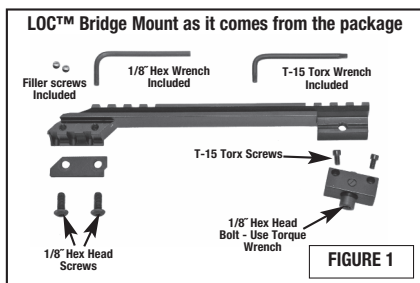

INSTALLING A BRIDGE SCOPE MOUNT CONTINUED

- This scope mount base is designed to provide maximum accuracy from the Dimension® rifle when it is installed correctly and then stay sighted-in when the barrel is changed out with another barrel (FIGURES 2 and 3).



Once installed, The LOC™ Bridge Mount stays sighted-in on the T/C Dimension® barrel when it is changed out for a different caliber barrel.



- As received from the factory, the Dimension® rifle has Weaver-style bases installed (FIGURE 4). These bases need to be removed to allow the LOC™ Bridge Mount to be installed.

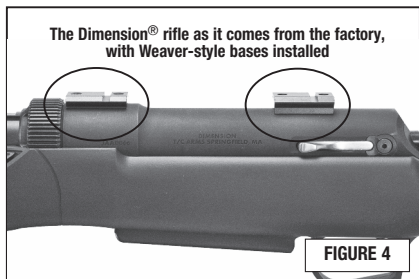

- Remove the Weaver-style bases from the receiver using the T-15 Torx wrench (see FIGURES 5 and 6).

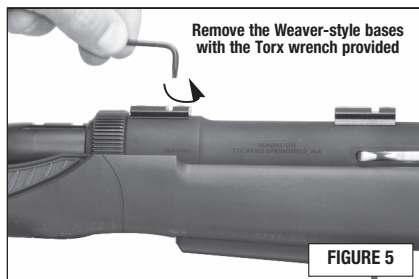

- Set the bases and screws aside for possible later use. Note that the rear base is taller than the front base - should you wish to reinstall them at some later date.

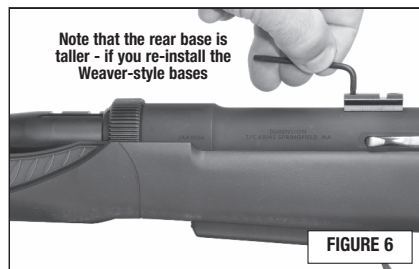

INSTALLING A BRIDGE SCOPE MOUNT CONTINUED

Use the supplied filler screws to plug the empty holes where the front base used to be (FIGURE 7).

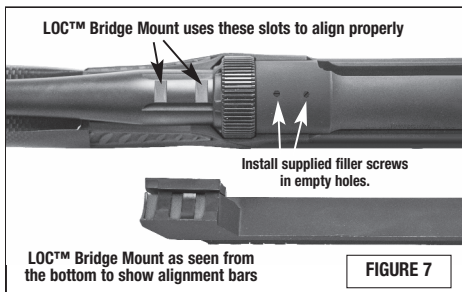

Assemble the front clamp of the scope mount as shown, with the 1/8" Hex screws loose (to allow assembly onto the barrel) so the mount will fit over the corresponding grooves in the rifle's barrel (FIGURE 7 & FIGURE 8).

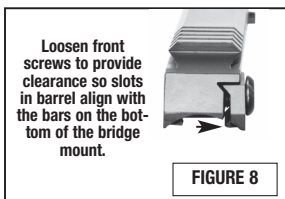

Install the LOC™ Bridge Mount rear adapter onto the receiver as shown (FIGURE 9) using the Torx Wrench to tighten the two screws. We recommend the use of LocTite® on these screws to help prevent them loosening during use.

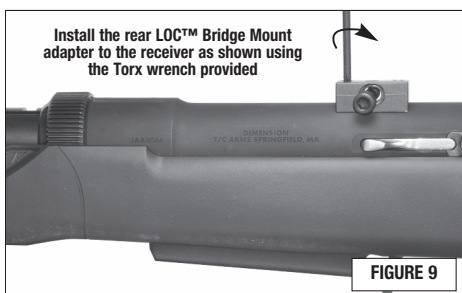

Follow the instructions provided with the LocTite® Threadlocker for proper application.

After assembling the front clamp with the two 1/8" hex screws, set the bridge mount into position and finger-tighten the two front screws and the rear screw to ensure that the mount is aligned correctly before final tightening is done (FIGURE 10).

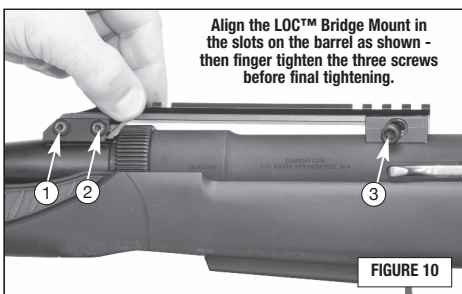

INSTALLING A BRIDGE SCOPE MOUNT CONTINUED

Tighten the two front screws using the 1/8" hex wrench. Do not exceed 25 inch/pounds torque (FIGURE 11).

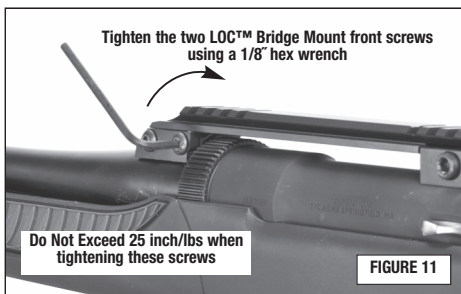

Tighten the rear screw using the 3/16" hex wrench end on the Torque Wrench that was supplied with the rifle. When the tool "clicks" the screw is tightened properly. Do not exceed 65 inch/pounds torque (FIGURE 12).

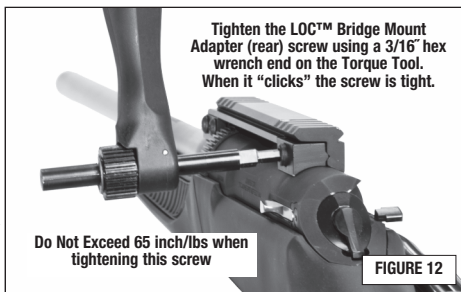

Proceed to install the rings and scope according to the manufacturer's instructions provided with those parts. We recommend T/C part number 50027 Low-Sporter Rings as a good match when using most one-inch diameter scopes (FIGURE 14).

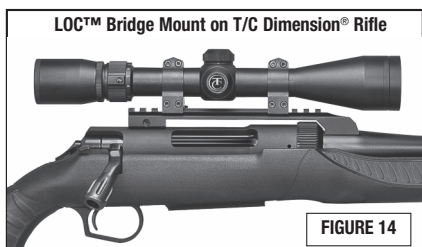
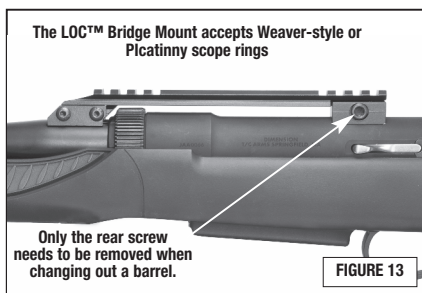

INSTALLING A BRIDGE SCOPE MOUNT CONTINUED

NOTE: The LOC™ Bridge Scope Mount Base is made to accept either Weaver-style rings or scope rings with Picatinny dimensions.

WHEN CHANGING OUT BARRELS

- When the user is ready to change barrels on the Dimension® rifle, follow the directions in this manual starting on page 27 after first fully loosening the rear 3/16" Hex screw (FIGURE 15). This screw is held captive in the base

adapter - once fully loosened, the screw stays with the adapter on the rifle - ready to thread into the LOC™ Bridge Mount being used with the new barrel.

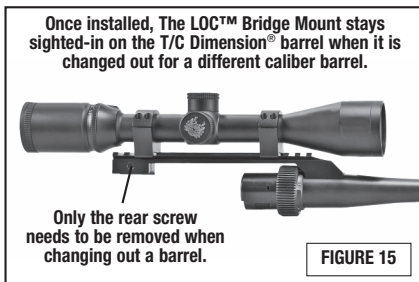

WARNING: FIRING A SCOPED FIREARM WITH YOUR EYE TOO CLOSE TO THE SCOPE EYE PIECE, OR FAILING TO HOLD THE FIREARM SECURELY AGAINST RECOIL, MAY RESULT IN SERIOUS PERSONAL INJURY INCLUDING, BUT NOT LIMITED TO, BLINDNESS.

LIMITED LIFETIME WARRANTY

This warranty is granted by Smith & Wesson Corp. doing business as Thompson/Center Arms. This warranty is effective from the date of purchase for the lifetime of the original retail purchaser of any factory finished firearm. In order to be eligible for service under this warranty, the original retail purchaser must return a completed authorized warranty card or register online at <http://www.tcarms.com/warranty-details/registration> within thirty (30) days of purchase of such firearm. With respect to such firearm, this warranty supersedes any and all other warranties.

Thompson/Center Arms brand firearms are warranted to be free from defects in material and workmanship. Any such defects of which Smith & Wesson receives written notice by the original retail purchaser will be remedied without charge within a reasonable time after such notification and delivery of the firearm as provided below.

Warranty claims (in writing) and the firearm or part thereof concerned should be delivered, postage prepaid, to the factory at Smith & Wesson, 2100 Roosevelt Ave., Springfield, MA 01104, Attn: Service Department. In addition, a copy of the bill of sale in the original retail purchaser's name, or, where applicable, a copy of ATF Form 4473 indicating date of purchase must be included. Please include your physical address and phone number. You must comply with all applicable federal, state and local laws and regulations in the shipment of firearms to Smith & Wesson.

NOTE: See the Contact & Shipping section of this manual for further details regarding returns.

Warranty claims should state the model and, where applicable, the serial number of the firearm concerned and the description of the difficulty experienced. It is recommended that shipments be insured by the owner, since Smith & Wesson will accept no responsibility for loss or damage in transit. Transportation and insurance charges for return to the owner will be paid by Smith & Wesson if the claim is covered by this warranty.

If the work required is not covered by our "Limited Lifetime Warranty" you will receive a quotation which must be authorized by you. No actual work will be done without your approval. Return shipments can be shipped via UPS, FedEx or mail at your cost. Repaired product will be shipped back to you via FedEx requiring an adult signature upon receipt.

UNDER NO CIRCUMSTANCES SHALL SMITH & WESSON BE RESPONSIBLE FOR INCIDENTAL OR CONSEQUENTIAL DAMAGES WITH RESPECT TO ECONOMIC LOSS, INJURY, DEATH OR PROPERTY DAMAGE, WHETHER AS A RESULT OF BREACH OF THIS WARRANTY, NEGLIGENCE OR OTHERWISE.

LIMITED LIFETIME WARRANTY CONTINUED

Some states do not allow the exclusion or limitation of incidental or consequential damages, so the above limitation or exclusion may not apply to you.

Smith & Wesson will not be responsible for:

- Defects or malfunctions resulting from careless handling, unauthorized adjustments or modifications made or attempted by anyone other than a qualified gunsmith following authorized procedures, or failure to follow the instructions in Safety & Instruction manual that was provided with the firearm from the factory.
- Use of defective or improper ammunition and/or propellant, corrosion, neglect, abuse, ordinary wear and tear, or unreasonable use.
- Use of replacement parts, including but not limited to barrels and springs, other than factory or authorized parts.
- Criminal misuse, negligence, or use under the influence of drugs or alcohol.

Services that were performed by the Thompson/Center Arms Custom Shop and/or that are performed by the Smith & Wesson Repair Department do not void this warranty. This warranty gives you specific legal rights, and you may also have other rights which vary from state to state.

NOTE: All liability is excluded in the event that the instructions provided in the Safety and Instruction manual that was provided with the firearm from the factory are not observed.

CONTACT AND SHIPPING FOR SERVICE

NOTE: A Return Merchandise Authorization (**RMA**) is the first step in the process of returning a product in order to receive a repair, replacement or refund.

Please contact Thompson/Center's Customer Service Dept. (e-mail: tca_customerservice@tcarms.com or by phone at 800-331-0852 ext. 4125) to obtain authorization to return your firearm so we can process it quickly and efficiently. The RMA number that is supplied by Thompson/Center Arms must be displayed on the outside of the returned product's packaging; returns without an RMA number will be routed differently which will result in delayed processing.

The issuance of an Return Merchandise Authorization (**RMA**) allows Thompson/Center Arms an opportunity to try to diagnose and correct a customer's concerns with the product (such as ammunition problems) before it is returned. Accordingly, please contact us before returning your Thompson/Center firearm.

Shipping Address: Thompson/Center Arms
2100 Roosevelt Avenue
Springfield, MA 01104

Should your Thompson/Center firearm require service, it should be returned to the Thompson/Center factory.

- Call or e-mail the Customer Service Dept. for authorization and shipping instructions.
- Ensure that the magazine and chamber are unloaded.
- **Do not attempt to ship a firearm via US Postal Service; only federally licensed dealers may ship a firearm by US Postal Service.**
- **DO NOT SHIP ANY AMMUNITION.**
- Enclose a letter which includes your full name and address (no P.O. Boxes, please), daytime telephone number, e-mail address, the serial number of the firearm, and details of the problem experienced (stating the brand and type of ammunition used when the problem occurred) or work desired.
- Record the serial number before shipping, in case you wish to check on the repair status of your firearm.
- Please remove all custom parts and accessories, such as stocks, special sights and scopes, or slings from your firearm before returning.
- Place the firearm in its original case or in a similarly secure container and pack it securely.

CONTACT AND SHIPPING CONTINUED

- The package must **NOT** bear any markings which indicate the identity of the contents.
- It is most important that you comply with federal, state, and local laws and regulations. The following guidelines are meant to help, but you must seek assistance from the appropriate authorities if necessary.
- If your firearm must be replaced, it **may** be necessary to ship the replacement to a dealer rather than directly to you. You **may** be requested to furnish a signed FFL (Federal Firearms License) from your dealer in such an instance.
- Warranty repair work will begin upon receipt and examination of the firearm. In the case of repairs or work not covered by the warranty, a quotation covering the cost of the work plus shipping charges will be sent to you. Repairs or modification will be scheduled upon receipt of payment.



WARNING: YOU MAY PURCHASE ACCESSORIES FOR YOUR THOMPSON/CENTER FIREARM. YOU MUST HAVE SOME OF THESE PARTS INSTALLED BY A GUNSMITH QUALIFIED TO PERFORM SERVICE ON THOMPSON/CENTER FIREARMS. NEVER ATTEMPT TO MODIFY YOUR FIREARM OR INSTALL REPLACEMENT PARTS IN YOUR FIREARM. ALWAYS USE A QUALIFIED THOMPSON/CENTER GUNSMITH EVEN IF THE REPAIR SEEMS SIMPLE.

PATENT INFORMATION

- This product may be covered by one or more patents. Visit www.tcarms.com for virtual patent information.

BATTERY WARNINGS



WARNING: IF A BATTERY OPERATED ACCESSORY OR ATTACHMENT (I.E. LASER, OPTICAL SIGHT OR FLASH-LIGHT, ETC.) IS SUPPLIED OR USED WITH THIS FIREARM, THE FOLLOWING WARNINGS AND INSTRUCTIONS MUST BE ADHERED TO.



WARNING: KEEP BATTERIES AWAY FROM CHILDREN. THERE IS A CHEMICAL BURN HAZARD ASSOCIATED WITH BATTERIES.



WARNING: IF A NEW OR USED LITHIUM BUTTON/COIN CELL BATTERY IS SWALLOWED OR ENTERS THE BODY, IT CAN CAUSE SEVERE INTERNAL BURNS AND CAN LEAD TO DEATH IN AS LITTLE AS 2 HOURS. ALWAYS COMPLETELY SECURE THE BATTERY COMPARTMENT. IF THE BATTERY COMPARTMENT DOES NOT CLOSE SECURELY, STOP USING THE PRODUCT, REMOVE THE BATTERIES, AND KEEP IT AWAY FROM CHILDREN. IF YOU THINK BATTERIES MIGHT HAVE BEEN SWALLOWED OR PLACED INSIDE ANY PART OF THE BODY, SEEK IMMEDIATE MEDICAL ATTENTION.

- When used correctly, batteries provide a safe and dependable source of portable power. However, misuse or abuse may result in leakage, fire, or explosion.
- Batteries can explode or leak and cause burns if installed backwards, disassembled, charged, or exposed to water, fire or high temperature.
- Always take care to install your batteries correctly observing the “+” and “-” marks on the battery and the device.
- Always replace the whole set of batteries at one time, taking care not to mix old and new batteries, or batteries of different types.
- Store unused batteries in their original packaging and away from metal objects that may short-circuit them.
- Remove discharged batteries from equipment promptly to avoid possible damage from leakage.
- Never dispose of batteries in fire. (Failure to observe this precaution may result in an explosion.)
- The batteries are supplied in a charged state and are not designed for recharging. Recharging may cause leakage, fire, or explosion.
- The batteries should be disposed of properly, including keeping them away from children.
- Dispose of used batteries immediately. Even used batteries may cause injury.

CONTACT INFORMATION

T/C Mailing Address:

(for questions & comments)

Thompson/Center Arms

2100 Roosevelt Avenue • Springfield, MA 01104

T/C Shipping Address:

(for repairs or warranty work)

Thompson/Center Arms

ATTN: Repair Department

2100 Roosevelt Avenue • Springfield, MA 01104

Web Address:

www.tcarms.com

Customer Service Phone:

Toll Free (866) 730-1614

Customer Service email:

tca_customerservice@tcarms.com



00084013