



GERMAN SPORT GUNS

FireFly



Instruction Manual



WARNING!

Please read and understand this owner's manual before taking your new FireFly pistol out of the box. It is vital to your safety and to the safety of others that you accurately follow the information contained in this manual, **as well as** the information supplied by the ammunition manufacturer.



FireFly

Table of Contents

1	General instructions	2	10	Scope of supply	22
1.1	Congratulations	2	10.1	Standard version	22
1.2	Firearms safety is your responsibility	2	10.2	Sport version	22
2	Safety regulations	3	10.3	Silencer version	22
2.1	Safety indications	4	10.4	Conversion set Sport version	22
3	Product description	6	10.5	Conversion set Silencer version	22
3.1	Main parts	6	11	Accessories	22
3.2	Technical data	6	13	Disposal	22
4	Transporting the pistol	7	14	List of replacement parts	22
5	Safety mechanisms	7			
5.1	Manual safety	7			
5.2	Integral safety lock (key operated)	7			
5.2.1	Magazine safety	8			
6	Handling the pistol	8			
6.1	General	8			
6.2	Ammunition	8			
6.3	Loading the magazine	9			
6.4	Loading the pistol (ready for firing)	10			
6.5	Firing	11			
6.6	Reloading during firing	12			
6.7	Unloading the pistol; magazine not empty	12			
6.8	Unloading the pistol; magazine empty, slide open	13			
7	Sight adjustment	14			
7.1	Sight adjustment for windage	14			
7.1.1	Rear sight adjustment	14			
7.2	Sight adjustment for elevation	14			
8	Pistol maintenance	15			
8.1	Field stripping the pistol	15			
8.2	Cleaning the pistol	16			
8.3	Pistol assembly	17			
8.4	Functional check	18			
8.5	Care of the pistol	19			
9	Service and repairs	19			
9.1	Fault detection, fault removal	19			
9.2	Safekeeping and storage of pistol	21			
9.3	Shipping the pistol	21			
9.3.1	Warranty Statement	21			



FireFly

General Instructions

1 General instructions

1.1 Congratulations

You are now the owner of one of the world's finest and most superbly engineered firearms. The GSG FireFly Pistol has been designed and crafted to meet the stringent requirements of law enforcement agencies and the military. Used with the proper ammunition and given reasonable maintenance, it will serve you dependably for many years.

To make sure you get the best performance and reliability from your pistol, please read and follow the procedures outlined in this manual.

You'll notice that we place a heavy emphasis on safe firearms handling. Like any other mechanical devices, such as automobiles or power tools, high quality firearms are inherently safe unless they are handled in a careless or irresponsible manner. Always remember that you, the owner, are the ultimate firearms safety device.

1.2 Firearms safety is your responsibility



WARNING!

Uncontrolled shot discharge with pistol safety off

Possibly death or serious injuries

PISTOLS are classified as FIREARMS and are sold by us with the specific understanding that we are not responsible in any manner whatsoever for their safe handling or resale under local laws and regulations.

GSG shall not be responsible in any manner whatsoever for malfunctioning of the firearm, for physical injury or for property damage resulting in whole or in part from

1. criminal or negligent discharge,
2. improper or careless handling,
3. unauthorized modifications,
4. defective, improper, hand-loaded, or reloaded ammunition,
5. corrosion,
6. neglect, or
7. other influences beyond our direct and immediate control.

This limitation applies regardless of whether liability is asserted on the basis of contract, negligence or strict liability (including any failure to warn).

Under no circumstances shall GSG be liable for incidental or consequential damages, such as loss of use of property, commercial loss and loss of earnings or profits.

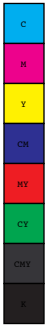



FireFly

Safety Regulations

2 Safety regulations

Please read and understand these instructions carefully before each and every handling of the GSG FireFly Pistol.

- Never use the pistol under the influence of drugs or alcohol, while ill or suffering other such difficulties. These conditions can impair your powers of judgment and reflexes.
- Always think of the pistol as being loaded and with the safety off until you have established the opposite through the unloading procedure.
- Always keep the muzzle of the pistol in a safe direction with all handling. A safe direction is towards an area where there are no people, other life forms or property that is not a recognized target.
- Never point the pistol at doors, panes of glass, walls, concrete, stone or flat surfaces (water included). A bullet can penetrate such surfaces or be ricocheted in an unsafe direction.
- Never aim at yourself or other life forms.
- Never rely on safety mechanisms alone. Safety mechanisms are not a substitute for careful, correct and secure handling of the pistol.
- Always treat your pistol as if the safety mechanisms were not functioning. The best safety precaution is a correct, well-trained and safe handling of the pistol.
- Never shoot with a pistol which has been penetrated by water, sand, dirt or other foreign bodies.
- Never decock the hammer by holding on to the hammer and pulling the trigger at the same time.
- Never let a loaded pistol out of your hand.
- Always unload the pistol immediately after firing, before putting the pistol away, putting into a holster or handing it to another authorized person.
- Never give the pistol to a person who has not thoroughly familiarized himself or herself with the safety instructions and handling of the pistol, by reading the corresponding instructions.
- Never leave the pistol lying unattended. Unauthorized persons could cause damage with it, threaten or kill other people, for which you could be held liable.
- Never store the pistol loaded, but remove the magazine and verify that there is no cartridge left in the chamber of the barrel by following the unloading procedure.
- Always keep the pistol and the ammunition separate from one another, and ensure that neither is obtained by unauthorized persons or children.



GERMAN SPORT GUNS

FireFly



Safety Regulations

2.1 Safety indications

In the individual sections of these instructions, the following safety indications alert you to risks:



WARNING!

Information on dangers, which if not scrupulously observed, can lead to severe bodily harm or death.



CAUTION!

Information on dangers, which if not scrupulously observed, can lead to bodily harm, damage to property and damage to the pistol.



CAUTION!

Information on technical requirements, which if not scrupulously observed, can lead to damage to the pistol.

- Each of these safety indications consists of:
 - a headline with a signal word, a signal pictorial and a corresponding color code
 - a description of the danger type and source
 - a description of possible consequences if the safety indications message is ignored
 - a description of actions or regulations for danger prevention

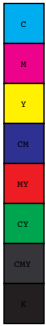



FireFly

GERMAN SPORT GUNS
Product Description



Fig. 1, Standard version

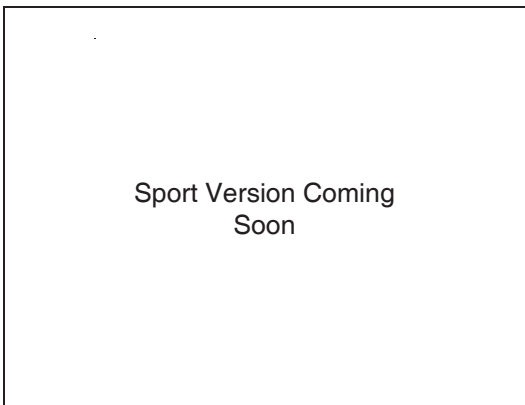

Fig. 2, Sport version



Fig. 3, Silencer version

5 US





FireFly

Product Description

3 Product description

3.1 Main parts

Item Description

- 1 Barrel block
- 4 Slide
- 5 Front sight A, B, C
- 6 Rear sight
- 15 Frame
- 16 Takedown lever
- 18 Slide catch lever
- 20 Trigger

Item Description

- 29 Hammer
- 40 Decocking lever
- 43 Magazine catch
- 46 Manual safety
- 51 Magazine
- 77 Counterweight ^a
- 78 Cap ^a
- 81 Threaded cap ^b

a. only Sport version
b. only Silencer version

3.2 Technical data

Technical data	Standard version	Sport version	Silencer version
Calibre	.22 Long Rifle	.22 Long Rifle	.22 Long Rifle
Overall length	7.2 in	207 in	207 in
Overall height	5.3 in	5.3 in	5.3 in
Overall width	1.5 in	1.5 in	1.5 in
Barrel length	3.9 in	4.9 in	4.9 in
Rifling length	1 in 15, right	1 in 15, right	1 in 15, right
Number of grooves	6	6	6
Sight base	7.2 in	6.5 in	7.2 in
Weight without magazine	22.9 oz.	26.1 oz.	22.9 oz.
Magazine weight, empty	1.7 oz.	1.7 oz.	1.7 oz.
Trigger pool, approx.	SA 4.0 lbs DA 12.1 lbs	SA 4.0 lbs DA 12.1 lbs	SA 4.0 lbs DA 12.1 lbs
Magazine capacity/rounds	10	10	10

Subject to change without notice

4 Transporting the pistol



WARNING!

Uncontrolled discharge of shot May lead to death or severe injuries

- For your own safety and the safety of others, always transport the pistol unloaded (see section 6.7 and 6.8), decocked and closed.
- Never carry a pistol with the hammer cocked and a round in the chamber.
- Always carry the pistol so that if you fall or slip, you always maintain control of the muzzle.
- Transport the pistol separate from the ammunition, in a locked case.
- Keep the firearm out of the reach of children, and other inexperienced or unauthorized persons.
- Follow all applicable Federal, State, & local regulations regarding the transport of firearms.

5 Safety mechanisms



WARNING!

Uncontrolled shot discharge Possibly death or serious injuries

- Never completely trust any safety mechanism. Any safety mechanism can break down or malfunction. The safest pistol is one that is fully unloaded.

5.1 Manual safety

Engaging manual safety:

1. Push the safety lever (manual safety) **46** down fully to engage (see Fig. 6 on page 13). This prevents firing of the pistol.

Disengaging manual safety:

1. Push safety lever (manual safety) **46** up fully to disengage (see Fig. 6 on page 13). Red dot is visible. This allows the pistol to be fired.

5.2 Integral safety lock (key operated)

Locking: (see Fig. 5, on page 8)



WARNING!

Uncontrolled shot discharge Possibly death or serious injuries

- Pistol must be decocked.
1. Insert key into opening at bottom rear of the grip.
 2. Push key to depress lock and rotate 90 degrees.
 3. Remove key leaving end of lock below the grip surface (see Fig. 5, on page 8, right).

This locking feature prevents the firing of the pistol.

Unlocking: (see Fig. 4, left/right)



WARNING!

Uncontrolled shot discharge Possibly death or serious injuries

- Pistol must be decocked.
1. Insert key into opening at bottom rear of grip. Push key to depress lock and rotate 90 degrees.



GERMAN SPORT GUNS

FireFly

Safety Mechanisms

Handling

- Remove key leaving end of lock flush or even with bottom of grip (see Fig. 4, right).

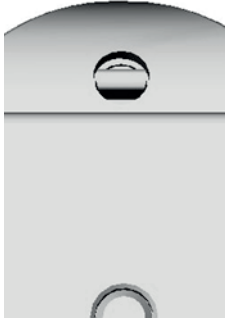

Fig. 4, decocked (left), unlocked (right)

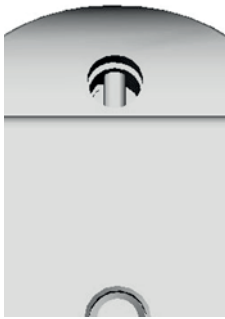

Fig. 5, secured (left), locked (right)

5.2.1 Magazine safety

Removing the magazine fully from the pistol prevents the pistol from being fired. The magazine must be fully inserted into the magazine well in order to fire the pistol.

6 Handling the pistol

6.1 General

The pistol is generally delivered preserved with a thin, protective grease and oil coating and must be stripped before being used for the first time, protective oil or grease removed and lubricated again. "First use" (see section 9).

Procedure:

- Strip pistol (see section 9.1).
- Clean and relubricate pistol (see section 9.2).
- Assemble pistol (see section 9.3).

6.2 Ammunition



WARNING!

Inadmissible ammunition

Possibly death or serious injuries and damage to the pistol

- For your pistol, use only commercial grade ammunition in its original packing for which corresponds with the calibre of the pistol. The correct calibre is imprinted on the pistol .22 Long Rifle.
- Never use reloaded, "refurbished", hand-loaded, non-standard ammunition or ammunition of a different calibre.
- Never use dirty, wet, corroded, bent, damaged or oiled ammunition.
- Never leave the ammunition lying unattended.



FireFly

Handling

Information:

The FireFly pistol has been constructed according to updated knowledge of modern gun manufacturing for caliber .22.

We have therefore decided to make an adjustment to the loads that have priority for use with the FireFly, which are the two major groups, utility and high-speed rounds. So to increase the round compatibility, we provide two slide springs for every pistol. The bigger bored version is designed for high-speed loads and is fitted in the pistol with delivery. The simple coiled smaller spring (marked white) is for standard loads and is supplied with the pistol.

Tip:

It has been proven that many types of utility rounds function more smoothly if the rounds are lightly oiled.

6.3 Loading the magazine

Procedure:

1. Place round on feeder close to the magazine lips.
2. Push the side lock on the magazine down.
3. Only load the number of rounds that are to be shot (max.10 rounds).

The number of inserted rounds can be determined through the slot on the magazine.



WARNING!

Uncontrolled shot discharge Possibly death or serious injuries

- Never oil high-speed rounds, as the pistol can unbolt too quickly while shooting.





6.4 Loading the pistol (ready for firing)



WARNING!

Lacking in awareness of potential dangers Possibly death or serious injuries

- Never load or unload the pistol inside a vehicle, inside a building or any other enclosed space (except in a designated firing range).
- Before loading always wipe off any excess grease and oil and check to see if there are any foreign objects/ material in the barrel.
- Always keep the muzzle of the pistol pointed in a safe direction.
- Do not put your finger on the trigger. Keep your finger outside the trigger guard.
- Only insert the loaded magazine immediately before firing.
- Never cock the hammer back by hand, in order to prevent the unintentional discharge of the pistol.
- Never rely on the safety mechanisms alone. Safety mechanisms are not a substitute for careful and proper handling of the pistol.
- Never let a loaded pistol out of your hand.

Procedure:

1. Point pistol in a safe direction.
2. Insert full magazine and ensure that it is fully engaged.
3. Pull slide back fully and release.
 - The pistol is loaded and ready for firing in the single action (cocked) mode.
 - The pistol can now be decocked using the decocking lever. It is then loaded, decocked and ready for firing in the double action (decocked) mode.
 - The pistol is decocked and ready for firing.

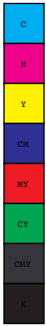



6.5 Firing



WARNING!

Lacking in awareness of potential dangers Possibly death or serious injuries

- Ensure that the target and surroundings allow shots to be fired without danger.
- Be certain when firing that your fingers, hands or other parts of the body are not in front of, above or beside the barrel muzzle or the ejector port.
- Never allow a person to stand next to you where they could be hit by ejected cartridge cases.
- When shooting, always wear ear protection and protective eye glasses. Inform other people close to you about the need to wear ear protection.
- Stop shooting immediately and unload the pistol if you suspect that a round is not inserted correctly, a case is jammed, a round may have blocked the barrel or a shot sounds or gives the sensation that it may be "weak" or unusual.
- Never try to dislodge a blockage by firing another round.



WARNING!

Missing Dry Fire Plug

Dry firing can cause damage to your pistol and create an unsafe condition

- Only dry fire your pistol with the Dry Fire Plug installed in the chamber and the manual safety off. Observe safe handling procedures when dry firing – keep the muzzle pointed in a safe direction!

Procedure:

1. Aim pistol at a safe target.
2. Place finger on trigger and squeeze the trigger (activates firing).
3. Keep the pistol aimed at the target and fire further shots as required.
4. Remove magazine and unload pistol. If the magazine has been shot empty, the slide remains in the open position. Reload pistol if further shots are to be fired.



WARNING!

Pistol is ready to fire

Possibly death or serious injuries

- Double action/single action pistols are in a cocked and ready to fire status after each firing.
- If you want to interrupt shooting, you must action the decocking lever to lower the hammer. The pistol is then in the loaded, decocked and ready to fire status.
- Once you decide to stop shooting immediately unload the pistol.

6.6 Reloading during firing

The slide is held in the open position.



WARNING!

**Lacking in awareness of potential dangers
Possibly death or serious injuries**

- Never let the pistol out of your hand.
- Keep the pistol aimed at the safe target.

Procedure:

1. Remove the empty magazine.
2. Insert full magazine and ensure that it is fully engaged.
3. Depress slide catch lever or retract slide fully and release.
 - The pistol is loaded and ready to fire.
 - The pistol can also be decocked using the decocking lever.
 - The pistol is now loaded, decocked and ready to fire.

6.7 Unloading the pistol; magazine not empty



WARNING!

**Pistol is ready to fire
Possibly death or serious injuries**

- Never let the pistol out of your hand before it is unloaded.
- The pistol is loaded; a round is in the chamber.
- Perform the unloading action with only two fingers from the rear.
- Never place your hand over the slide opening.

Procedure:

1. Keep the pistol muzzle pointed in a safe direction.
2. Press the decocking lever; the hammer is lowered and held in the safety notch.
3. Depress magazine catch and remove magazine.
4. Retract slide fully and engage the slide catch lever. The round is ejected and the slide is held in the open position.
5. Check (visually and manually with appropriate aid) to ensure that the round has been ejected and that there is no round in the chamber (see Fig. 6).
6. Depress slide catch lever - the slide closes.
7. Depress decocking lever - hammer lowers.
8. Empty magazine.
9. Pick up ejected round and clean pistol.

The pistol is unloaded and decocked.



GERMAN SPORT GUNS

FireFly

Handling



WARNING!

Not properly cleaned pistol
Possibly death or serious injuries, damage to the pistol

- The pistol must be cleaned after each firing. (see section 9.2).



Fig. 6

6.8 Unloading the pistol; magazine empty, slide open



WARNING!

Pistol is loaded
Possibly death or serious injuries

- You must not let the pistol out of your hand until the magazine has been removed and the pistol is unloaded.

Procedure:

1. Keep the pistol muzzle pointed in a safe direction.
2. Press magazine catch and remove magazine.
3. Check (visually and manually with appropriate aid) to ensure that there is no round in the chamber (see Fig. 6).
4. Depress slide catch lever - the slide closes.
5. Depress decocking lever - hammer lowers.

The pistol is unloaded and decocked.



WARNING!

Decocking lever
Possibly death or serious injuries

- Always use the **decocking lever** to decock your GSG pistol. This is the only way to safely lower the hammer from the cocked position and prevent an accidental discharge.
- Never lower the hammer by pulling the trigger and attempting to ease the hammer forward manually.
- **Manually lowering the hammer is dangerous** and prevents full application of the pistol's safety features - the consequence can be serious injury or death - only and **ALWAYS use the decocking lever!**

7 Sight adjustment



CAUTION!

Possibly damage to the pistol

- Any adjustment to sights should only be done on an unloaded pistol, by an armorer, gunsmith or other qualified person.

7.1 Sight adjustment for windage

7.1.1 Rear sight adjustment



CAUTION!

Possibly damage to the pistol when turning the adjusting screw clockwise

- Turn the adjusting screw **clockwise** only until you notice a light resistance. Do not turn the screw any further!
- The rear sight must not exceed the edge shown in Fig. 12.

Turning the lateral adjusting screw **clockwise** one full rotation moves the point of impact approximately 3 inches **to the left** at a distance of 25 yards.

Turning the lateral adjusting screw **counter clockwise** one full rotation moves the point of impact approximately 3 inches **to the right** at a distance of 25 yards.

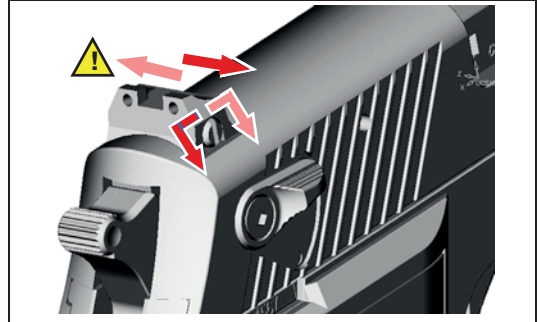

Fig. 11

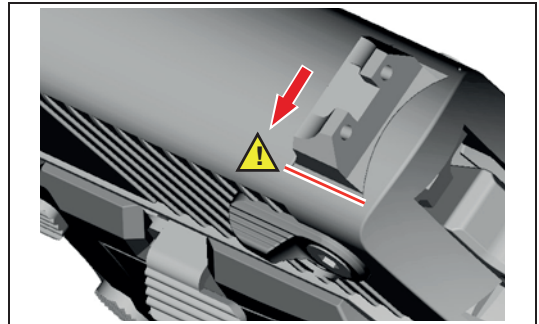

Fig. 12

7.2 Sight adjustment for elevation

Your pistol includes two additional front sights of different heights.

Changing to the **higher front sight lowers** the **point of impact** approximately 7.5 inches at 25 yards.

Changing to the **lower front sight raises** the **point of impact** approximately 7.5 inches at 25 yards.



8 Pistol maintenance



WARNING!

Pistol is ready to fire

Possibly death or serious injuries

- Magazine must be removed from the pistol.
- Before field stripping your pistol for cleaning, verify again that it is not loaded (see sections 6.7 and 6.8).
- Do not put your fingers into the slide.

8.1 Field stripping the pistol

Procedure:

1. Unload pistol (see sections 6.7 and 6.8).
2. Remove the threaded cap of the Silencer version (see chapter 7.2.1), resp. the counterweight of the Sport version (see chapter 7.1.1).
3. Retract slide **4** fully and lock open by engaging the slide catch lever **18** (see Fig. 13).



Fig. 13

4. Check to ensure there is no round in the chamber.

5. Depress slide catch lever to close slide.

6. Rotate takedown lever **16** clockwise 180° until it points forward (see Fig. 14).



Fig. 14

7. Retract slide fully; lift rear of slide until clear of frame and slowly move slide group forward towards muzzle end of pistol (see Fig. 15 and Fig. 16).



Fig. 15



Fig. 16



- Remove slide assembly (slide, recoil spring guide and recoil spring) from the barrel muzzle.

This level of stripping is sufficient for a thorough cleaning after firing.



CAUTION!

Possibly damage to the pistol

- Further dismantling of the pistol may only be carried out by qualified armorers and gunsmiths.

8.2 Cleaning the pistol



CAUTION!

Possibly damage to the pistol

- Never clean the barrel from the front (muzzle end) and never use steel brushes, as these can damage the smooth surface of the barrel. Use a suitable cleaning rod and brush designed for .22 caliber.
- Solvents can damage the surface of the pistol. Before using a cleaning or solvent agent, take note of the instructions and warnings provided by the manufacturer.

Procedure:

- Moisten cleaning brushes with gun oil and insert into the barrel through the chamber. Carefully remove all powder residue and dirt in the barrel and chamber with the cleaning brush.
- Remove powder residue and oil using from the chamber and barrel using a cleaning patch.
- Clean external surfaces of the barrel with a brush that has been moistened with gun oil.
- Wipe off frame, slide, recoil spring guide and recoil spring with a cloth lightly coated with gun oil or grease.
- Lightly oil barrel bore and chamber. Be sure to remove excess lubricant.



Fig. 17, Cleaning Standard version



GERMAN SPORT GUNS

Maintenance

FireFly



Sport Version
Coming Soon

Fig. 18, Cleaning Sport version



Silencer Version
Coming Soon

Fig. 19, Cleaning Silencer version

8.3 Pistol assembly

Procedure:

1. Inspect the pistol interior and remove any foreign matter.
2. Slide recoil spring 3 onto the spring guide 2.
3. Insert spring guide with recoil spring into the frame 15. The flat portion of the recoil spring guide faces the rear of the pistol.



CAUTION!

Frame, recoil spring guide and recoil spring are loosely connected
Possibly damage to the pistol and bodily harm

- Careful handling of the slide and the parts connected to the recoil spring.
4. Slip slide over the recoil spring and recoil spring guide.
 5. Retract the slide fully to the rear and down until the slide guide can click into the frame guide.
 6. Slowly move the slide forward until closed.
 7. Install the threaded cap of the Silencer version (see chapter 7.2.2), resp. the counterweight of the Sport version (see chapter 7.1.2).
 8. Rotate the takedown lever counter clockwise 180° until it points towards the rear of the pistol.

Note:

The pistol is unloaded and decocked.



FireFly

Maintenance

8.4 Functional check

Note:

The check of all functions must be made on the assembled pistol:

- to determine any causes of malfunctioning,
- after completion of repairs,
- and after each cleaning and assembly of the pistol.

Procedure:

1. Ensure the magazine is removed and pistol is unloaded (see sections 6.7 and 6.8).
2. Check spring tension of the recoil spring and slide cycling (no binding).
 - Retract slide fully and release.
 - Verify slide closes rapidly and fully under spring tension.
 - Repeat check again.
3. Check double action (DA).
 - Insert empty magazine (gun has a magazine safety).
 - Pull trigger fully with decocked hammer.
 - Verify hammer travels fully to rear and releases. Hammer should impact firing pin with adequate force. Hammer should reset into safety intercept notch (verify by pressing back of hammer).
4. Check trigger path and trigger interruption.
 - Insert empty magazine (gun has a magazine safety).
 - Pull trigger fully to rear and hold.
 - Retract slide fully and release.
 - Verify hammer remains cocked to rear; release trigger
5. Check single action trigger function (SA).
 - Insert empty magazine (gun has a magazine safety).
 - Pull trigger fully

- Hammer should fall & impact firing pin with adequate force. Hammer should reset into safety intercept notch.
6. Check decocking lever and hammer safety intercept notch.
 - Remove magazine
 - Cock hammer by retracting slide fully and releasing.
 - Depress decocking lever to lower hammer.
 - Verify hammer is locked in safety intercept notch by pushing back of hammer.
 7. Check slide catch lever.
 - Insert empty magazine; retract slide fully and release
 - Check that the slide remains locked to the rear.
 - Depress slide catch lever.
 - Verify slide closes fully and with adequate force.
 - Depress decocking lever. Remove magazine.
 8. Check magazine.
 - Inspect the magazine tube (lips and floorplate) for signs of damage or dirt.
 - Verify that magazine floorplate is properly secured.
 - Verify the feeder is under sufficient spring tension and is not binding during movement.
 - Insert the magazine into the pistol magazine well and ensure there is no binding.
 - Ensure the magazine catch does not bind when depressed and released.
 9. Check external condition of the pistol.
 - Inspect front sight, rear sight, grip plates and takedown lever for damage and dirt.
 - Verify tightness of sights and grip plates.



8.5 Care of the pistol



CAUTION!

Neglecting the pistol

Possibly damage to the pistol and bodily harm

- Always keep your pistol clean and in good working order.
- Clean the pistol after 250 rounds, before every ammunition type change and after every use. The chamber in particular must be thoroughly cleaned.
- Never change or repair parts of your pistol yourself.
- Have your pistol checked once a year by a qualified gunsmith or armorer, as defects, wear and tear, corrosion etc. may not always be visible from the exterior.
- For repair or service work, we recommend that you return your pistol to GSG.
- If you order replacement parts without returning the pistol, you are responsible for ordering the correct replacement part and its installation by a qualified gunsmith or armorer.

GSG cannot be held liable for pistol faults or malfunctions if the pistol has been modified or parts have been installed or repaired by third parties.

9 Service and repairs

9.1 Fault detection, fault removal

Faults can be prevented with the proper maintenance of the pistol (cleaning and inspection). Should, however, a malfunction occur while firing, proceed as follows:



WARNING!

Uncontrolled shot discharge

Possibly death or serious injuries

- Keep the pistol pointed in a safe firing direction and remove your finger from the trigger while you carry out the steps shown below.
1. Remove the magazine.
 2. Retract the slide fully and lock to the rear (open) using the slide catch lever.
 3. Check (visually and manually with appropriate aid) to ensure there is no round, bullet, case or foreign bodies in the chamber or in the barrel bore. If a bullet is lodged in the barrel bore, strip the pistol and have the bullet removed by a qualified gunsmith using the proper tools.
 4. Remove all ammunition & foreign matter. Clean, lubricate and assemble pistol.
 5. Have pistol checked by a gunsmith or armorer.



FireFly

GERMAN SPORT GUNS
Servicing



Part/fault	Possible cause of fault/defect	Possible fault/defect removal
Ammunition feeding: Failure to feed.	Magazine is not inserted correctly, deformed or dirty.	Insert magazine correctly or replace it.
	Pistol or rounds dirty or greased too much.	Strip, clean and lubricate pistol, clean or replace ammunition.
	Failure to chamber.	Large (heavy) slide spring installed and standard ammunition used.
	Pistol defective.	Repair by manufacturer.
Slide: Slide does not close properly.	Pistol or rounds dirty or greased too much.	Strip, clean and lubricate pistol, clean or replace ammunition.
	Pistol defective.	Repair by manufacturer.
Case ejection: Empty case remains in the chamber or gets stuck in ejector port.	Underloaded ammunition.	Replace ammunition.
	Recoil not sufficient due to dirt.	Strip, clean and lubricate pistol.
	Pistol defective.	Repair by manufacturer.
Misfiring: Hammer hits; no discharge.	Firing pin sticks in the firing pin guide.	Strip, clean and lubricate pistol. Have pistol checked by armorer.
	Ammunition fault.	Manually cycle slide to load new round
	Pistol defective.	Repair by manufacturer.





FireFly

9.2 Safekeeping and storage of pistol



WARNING!

Uncontrolled shot discharge Possibly death or serious injuries

- Only store your pistol unloaded and cleaned.
- Keep your pistol separate from ammunition and locked away. The pistol and ammunition must always be in a place inaccessible to children and unauthorized persons.

Service:

www.americantactical.us

1-800-290-0065

customerservice@americantactical.us

For all warranty questions please have a look on the American Tactical warranty page.

9.3 Shipping the pistol

Note:

- Familiarize yourself with all laws and regulations governing shipping and transport of firearms.
1. Check pistol to ensure it is unloaded and decocked.
 2. Pack the pistol well (if possible in the original packaging) to prevent damage during shipment. If returning in original case, cover the case with a second outer layer. Ammunition and accessories (other than magazines) should not be included in the package.
 3. Enclose a letter with the following information:
 - Your name
 - Your address
 - Your telephone number, at which you can be contacted during the day
 - A detailed description of the problems encountered or the work that is to be carried out.
 4. Send the pistol insured and postage paid (parcels with incorrect postage will not be accepted) to:

- Be sure to retain your sales slip as proof of purchase date when making a claim.



GERMAN SPORT GUNS

FireFly

Scope of supply

Accessories

10 Scope of supply

10.1 Standard version

- 1 Pistol
- 1 Magazine
- 1 Gun case
- 1 Safety & Handling booklet
- 1 Test group card
- 1 Cable lock
- 1 Dry fire plug
- 1 Gun oil
- 2 Exchangeable front sights
- 1 Recoil spring

10.2 Sport version

As Standard version and additionally: 1

- x Allen wrench

10.3 Silencer version

As Standard version and additionally: 1

- x Assembly wrench

10.4 Conversion set Sport version 1

- x Barrel Sport version

1 x Counterweight

1 x Cap

1 x Threaded pin

1 x Allen wrench

10.5 Conversion set Silencer version

1 x Barrel Silencer version

1 x Threaded cap

1 x assembly wrench

11 Accessories

- Case locks
- Gun oil
- Leather holsters
- Kydex holsters
- X-POINT sights
- Mount for X-POINT sights

12 Disposal

- Comply with all Federal, State & local laws regarding the disposal of handguns.

13 List of replacement parts

Required information when ordering replacement parts

- Pistol type (calibre, description of type)
- Pistol number
- Item number
- Part designation

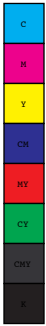



FireFly

GERMAN SPORT GUNS

List of replacement parts

Pos.-Nr. Item Description

- | | | | |
|----|------------------------------------|----|-------------------------------------|
| 1a | Barrel a | 35 | Action Casing Half (Left) |
| 1b | Barrel b | 36 | Ball Centering |
| 1c | Barrel c | 37 | Action Casing Half (Right) |
| 2 | Recoil Spring Guide | 39 | Magazine Safety |
| 3 | Recoil Spring, White (Standard) | 40 | Decocking Lever |
| 4 | Slide | 42 | Decocking Lever Spring |
| 5 | Front Sight A | 43 | Magazine Catch |
| 5 | Front Sight B | 44 | Safety Lever (Manual Safety), Right |
| 5 | Front Sight C | 45 | Magazine Catch Spring |
| 6 | Rear Sight | 46 | Safety Lever (Manual Safety), Left |
| 7 | Slide Breech Block Pin | 48 | Grip Plate, Right |
| 8 | Trigger Bar Spring | 49 | Grip Plate, Left |
| 9 | Breech Block | 50 | Grip Plate Screw |
| 11 | Firing Pin | 51 | Magazine |
| 12 | Firing Pin Spring | 56 | Threaded Socket For Grip Plates |
| 13 | Safety Lock | 57 | Retainer |
| 14 | Safety Lock Spring | 58 | Screw For Grip |
| 15 | Frame | 59 | Hammer Reset Spring |
| 16 | Takedown Lever | 60 | Hammer Pivot Pin |
| 17 | Stike Pin For Integral Safety Lock | 62 | Trigger Bar Pin |
| 18 | Slide Catch Lever | 63 | Spring For Magazine Safety |
| 19 | Slide Catch Lever Spring | 64 | Safety Lever Pin |
| 20 | Trigger | 65 | Magazine Safety Pivot Pin |
| 21 | Trigger Pivot | 66 | Screw For Decocking Lever |
| 22 | Trigger Bar | 67 | Screw For Safety Lever |
| 23 | Lock | 69 | Key |
| 24 | Sear | 70 | Main Spring Washer |
| 25 | Takedown Lever Insert | 71 | Main Spring Washer |
| 27 | Spring For Integral Safety Lock | 75 | Breech Block Pin |
| 28 | Safety Lever | 76 | Breech Block Spring |
| 29 | Hammer | 77 | Counterweight |
| 30 | Spring For Safety Lever | 78 | Cap |
| 31 | Ball For Safety Lever | 79 | Threaded Pin |
| 33 | Hammer Strut | 81 | Threaded Cap |
| 34 | Mainspring | 82 | Assembly Wrench |
| | | 83 | Breech Block Pin |





FireFly

GERMAN SPORT GUNS

List of replacement parts

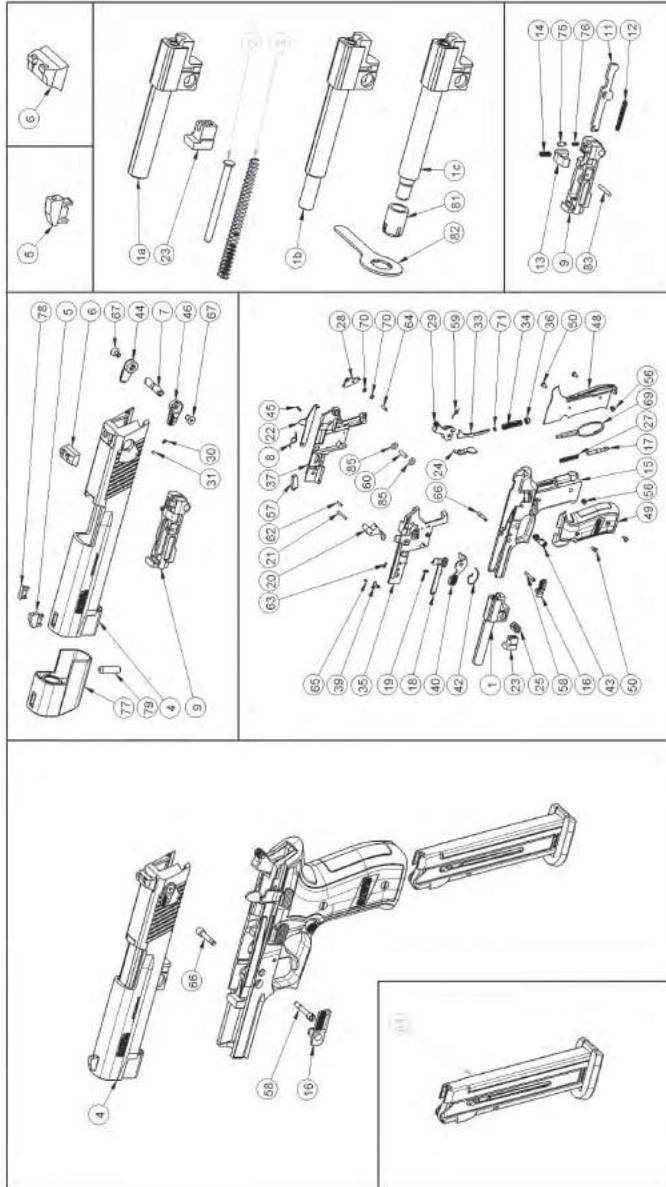
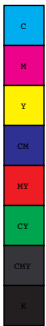

Fig. 20, Spare parts for GSG FireFly



Notice



Notice

