

STORING YOUR SHOTGUN IN A CARRYING CASE IS NOT ADVISABLE. RUST MAY OCCUR DUE TO TRAPPED MOISTURE IN THE CASE.

## 1-SAFETY RULES

**WARNING: THE FAILURE TO FOLLOW THESE SHOTGUN SAFETY REQUIREMENTS WILL CAUSE SERIOUS PERSONAL INJURY OR DEATH TO YOU OR OTHERS.**

- ALWAYS TREAT A FIREARM AS IF IT WERE LOADED. NEVER ASSUME THAT IT IS UNLOADED.
- NEVER POINT THE FIREARMS AT SOMETHING THAT IS NOT SAFE TO SHOOT.
- ALWAYS STORE FIREARMS TO PREVENT CHILDREN FROM HAVING ACCESS TO THEM. IT IS YOUR RESPONSIBILITY TO INSURE THAT UNAUTHORIZED PERSONS DO NOT GAIN ACCESS TO YOUR FIREARM. TO REDUCE THE RISK OF ACCIDENTS INVOLVING CHILDREN, UNLOAD YOUR FIREARM, LOCK IT AND STORE THE AMMUNITION IN A SEPARATE LOCKED LOCATION.
- ALWAYS WEAR ADEQUATE AND PROPER EAR PROTECTORS.
- ALWAYS WEAR SAFETY PROTECTIVE GLASSES SPECIFIED FOR FIREARM USE.
- ALWAYS BE ALERT AND ALWAYS FOLLOW THE SAFETY INSTRUCTIONS OF THE RANGE OFFICER. NEVER SHOOT IF YOU ARE TIRED, COLD OR IMPAIRED IN ANY WAY.
- ALWAYS BE AWARE OF YOUR SURROUNDINGS, AND BE ALERT THAT PEOPLE CAN WALK INTO YOUR LINE OF FIRE.
- THE SHOOTER (AND ALL OTHERS IN THE SHOOTING AREA) MUST ALWAYS BE IN A POSITION THAT IS OUT OF THE LINE OF FIRE.
- NEVER SHOOT AT HARD SURFACES, WATER OR RANDOMLY INTO THE SKY. ALWAYS SELECT A PLACE TO SHOOT THAT HAS A SAFE BACKSTOP AND IS FREE FROM OBSTRUCTIONS AND WATER SURFACES WHICH CAUSE RICOCHETS.
- NEVER CLIMB A TREE, FENCE OR OBSTRUCTION WITH A LOADED FIREARM. OPEN AND EMPTY THE CHAMBER OF YOUR FIREARM AND ENGAGE THE MANUAL SAFETY BEFORE CLIMBING OR DESCENDING A TREE OR BEFORE CLIMBING A FENCE OR JUMPING OVER A DITCH OR OBSTRUCTION.
- NEVER TRANSPORT A LOADED FIREARM.
- NEVER USE ALCOHOL OR DRUGS BEFORE OR WHILE SHOOTING OR HANDLING ANY FIREARM.

## 2-NOMENCLATURE

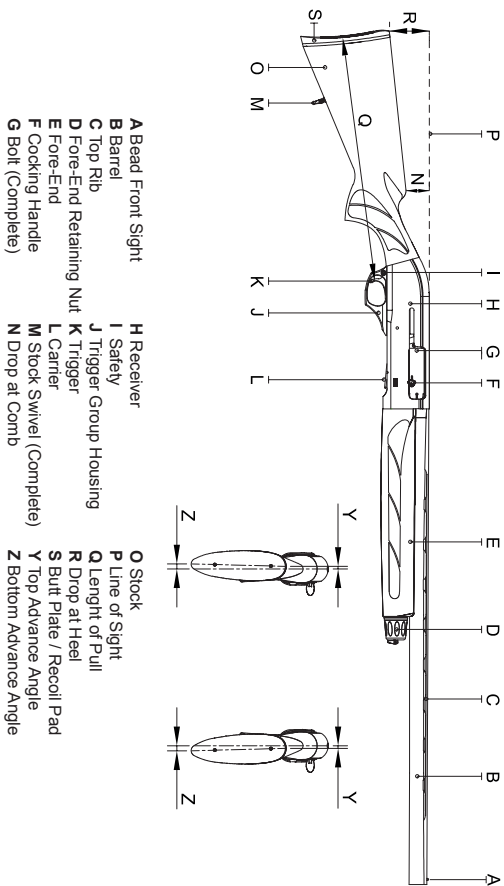

### 3-INITIAL ASSEMBLY AND INSPECTING

- Your shotgun is shipped from the factory with the barrel not assembled to the receiver(Figure 1).



- Unscrew the fore-end retaining nut (Figure 2) and remove the fore-end by pulling it forward (Figure 3).



- Next, assemble the barrel to the receiver(Figure 4). When doing this you might need to pull/release the cocking handle for easier fitting. Assemble the fore-end (Figure 5) and then screw the fore-end retaining nut (Figure 6).

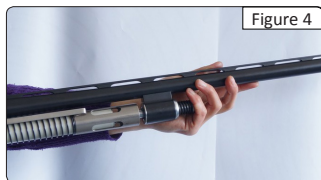

## 4-SAFETY BUTTON

The safety is designed to stop the trigger mechanism.

The safety on any gun is a mechanical device, and it is not intended as a substitute for common sense or safe gun handling. Always keep the muzzle pointed in a safe direction.

- The safety is located behind the trigger, and provides protection against accidental or unintentional discharge under normal usage when properly engaged.

- To engage the safety, push the button so that it protrudes from the right side of the gun and the RED RING CAN NOT BE SEEN (Figure 7). The safe should always be in the “on” or “safe” position until you intend to fire the gun.

- When you are ready to fire the gun, press the safety button to the “off” or “fire” position, so that the safety protrudes from the left side of the shotgun and the RED RING APPEARS (Figure 8).

**WARNING: The gun will fire when the trigger is pulled intentionally or accidentally when the RED RING APPEARS.**



## 5-LOADING AND USAGE

**WARNING: WHILE LOADING, KEEP THE SAFETY "ON" AT ALL TIMES AND KEEP THE MUZZLE AIMING AT A SAFE DIRECTION.**

To load your semi-automatic shotgun, pull the cocking handle backward till it is locked (Figure 9) and press the bolt release button (Figure 10). Looking at the bottom of the gun, you will see that it is possible to move the carrier into the receiver. You can now insert shells in the magazine tube using your thumb (Figure 11). Note that your gun is factory limited to 3 shells - 2 in the magazine and 1 in the chamber - using a magazine plug. To chamber a shell when you are done with loading, push the shell drop lever located at the back of the carrier (Figure 12). This will drop a shell onto the carrier.

After that pull the cocking handle backwards and release it. The shell on the carrier will be chambered with the support of the bolt (Figure 13) and you can add one (1) more shell to the magazine tube. Now you are ready to fire.

**WARNING: To prevent unexpected ignition and potential injuries, be certain that each round you use is in the proper gauge!**

**Always keep your fingers away from the trigger while loading/unloading your gun!**



Figure 9



Figure 10



Figure 11



Figure 12



Figure 13

## 6-UNLOADING

**WARNING: WHILE UNLOADING, KEEP THE SAFETY “ON” AT ALL TIMES AND KEEP THE MUZZLE AIMING AT A SAFE DIRECTION.**

Push the bolt release button and the carrier simultaneously. You will see that the shells will be ejected from the magazine tube (Figure 14). When all the shells are ejected, control the chamber by pulling the cocking handle backwards so that any shell in the chamber will be ejected (Figure 15).

**Always keep your fingers away from the trigger while loading/unloading your gun!**



## 7-DISASSEMBLY

- Unscrew the fore-end retaining nut (Figure 16), and remove the fore-end (Figure 17). Take the barrel off by pulling it forward (Figure 18).

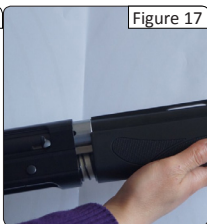
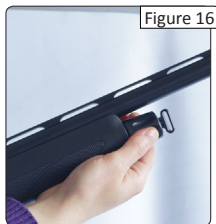

- Grabbing the action bar in the hand and pulling the recoil spring slowly backwards, remove the cocking handle (Figure 19). For taking the cocking handle out or inserting it into its slot, the lateral side surface of the cocking handle must center the hole on located on the bolt (Figure 20). This can be achieved by pushing the bolt with your thumb.



## 7-DISASSEMBLY

- Next, remove the bolt (Figure 21), action bar (Figure 22), and the recoil spring (Figure 23). Take the gas piston located in the gas chamber out that is under the barrel by pulling it with your fingernails (Figure 24).



- Using a tool (if necessary, a soft head hammer) remove the pin (Figure 25) and take the trigger group housing out (Figure 26).





## 8-REASSEMBLY

- Firstly, place the trigger group housing (27), and insert the trigger group housing pin (28). Before putting the trigger group housing into its place, make sure that the hammer is cocked. Figure 29 shows the cocked state, and Figure 30 shows the decocked state of the hammer.



Figure 27



Figure 28



Figure 29



Figure 30

- Afterwards, mount the recoil spring and insert the action bar and bolt group to the receiver (Figure 31), and insert the cocking handle into its slot (Figure 32). For taking the cocking handle out or inserting in into its slot, the lateral side surface of the cocking handle must center the hole on located on the bolt.



Figure 31



Figure 32





## 8- REASSEMBLY

- Now, insert the gas piston into the gas chamber located under the barrel (Figure 33), and attach the barrel to the receiver (Figure 34), assemble the forend (Figure 35), and finally screw the forend retaining nut (Figure 36).



## 9-USE OF CHOKE TUBES

With the choke tubes you can control the openness or tightness of the pattern of your shotgun. The chart below lists the chokes available (from open to tight), and the corresponding marks that indicate the choke of your shotgun.

AMERICAN DESIGNATION	CL (Cylinder)	IC (Improved Cylinder)	M (Modified)	IM (Improved Modified)	F (Full)
CHOKE TUBE					
NOTCHES	★★★★★	★★★★	★★★	★★	★

All the five choke tubes are included in the package in a specially designed box.

**WARNING:** When installing a choke tube in your barrel, make sure that the tube is completely screwed down tight in the barrel, never shot your shotgun without the choke tubes installed as this may damage the barrel and injure the shooter. Choke tubes may become loose after extended firing and should be checked frequently of tightness.

## 9-USE OF CHOKE TUBES

### INSTALLATION OF CHOKE TUBES

**WARNING:** Check that the firearm is unloaded. If not, unload the firearm by operating as described in the chapter “Unloading”. Never look into the muzzle or change tube on a loaded gun; even with safety is set “on”.

- Apply a thin coat of gun oil to the threads of the barrel and of the choke tube.
- Insert the desired chokes into the choke housing. Take care the notched end will be upside.
- Carefully hand screw the chokes into the barrels clockwise (Figure 45). Using the choke tube Wrench; tighten the choke until it is fully bottomed into its recess in the barrel.
- Remove the choke tube wrench after tightening.

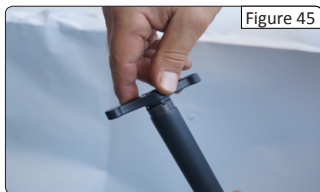

Figure 45

## 9-USE OF CHOKE TUBES

### REMOVAL OF CHOKE TUBES

**WARNING:** Check that the firearm is unloaded. If not, unload the firearm by operating as described in the chapter “Unloading”. Never look into the muzzle or change tube on a loaded gun, even with safety engaged.

- Unscrew (counterclockwise) the choke tube using the choke tube wrench supplied (Figure 46). Remove the choke tube from the muzzle (Figure 47).

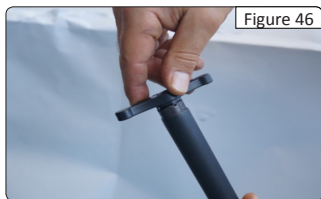

Figure 46

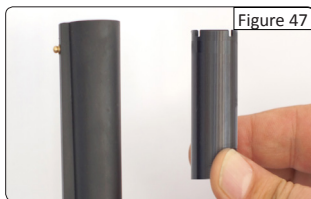

Figure 47

### CLEANING OF CHOKE TUBES

**WARNING:** Check that the firearm is unloaded. If not, unload the firearm by operating as described in the chapter “Unloading”. Never look into the muzzle or change tube on a loaded gun, even with safety is set “on”.

- Carefully clean the choke housing. If necessary, use a cotton patch coated with gun oil.
- Check the choke to make sure it is perfectly clean inside and outside.
- Apply a thin coat of gun oil to the threads of the barrel and of the choke tube.

## 10-PARTS LIST

1	Receiver
3	Magazine Tube
4	Front Magazine Plug
5	Magazine Spring
6	Magazine Plug
7	Recoil Spring
8	Stock Retaining Nut
9	Stock
9A	Stock Shim
10	Stock Washer
12	Through Bolt
13	Recoil Pad
14	Butt Screws (2 Pieces)
15	Sling Swivels (2 Pieces)
16	Sling Swivel Screws (2 Pieces)
17	Sling Swivel Capscrew (Stock)
18	Bolt Release Button Spring
19	Bolt Release Button
20	Bolt Release Button Pin
21	Carrier Lock Spring
22	Carrier Lock
23	Carrier Lock Pin
24	Bolt Take-Up Pin Stop
25	Bolt Take-Up Spring
26	Bolt Take-Up Pin
27	Extractor Spring
28	Extractor
29	Extractor Spring Pin
30	Lock
31	Gas Discharge Spring
32	Firing Pin Spring
33	Firing Pin
34	Firing Pin Stop
35	Extractor Retaining Pin
36	Bolt
37	Action Bar
38	Cocking Handle

39	Gas Discharge Retaining Screw
40	Gas Discharge Washer
41	Piston
43	Fore-End
44	Barrel
45	Sling Swivel Support
47	Fore-End Retaining Nut Spring
48	Fore-End Retaining Nut
49	Safety
50	Safety Spring Guide
51	Safety Spring
52	Safety Spring Pin
53	Trigger
54	Disconnecter Spring
55	Disconnecter Spring Pin
56	Disconnecter
57	Disconnecter Pin
58	Trigger Spring
59	Trigger Stop Pin
60	Trigger Pin
61	Carrier Lever
61-A	Carrier Lever Pin Bearing
62	Carrier
63	Carrier Lever Rivet
64	Hammer Spring
65	Hammer Spring Guide
66	Hammer
67	Hammer Retaining Pin
68	Retaining Circlip
69	Shell Drop Lever Spring
70	Shell Drop Lever
71	Shell Drop Lever Pin
72	Carrier Lever Spring
73	Carrier Lever Spring Pin
74	Trigger Group Housing
75	Trigger Group Retaining Pin
76	Bead Front Sight
77	Choke Tube

INDEX

---

1.SAFETY RULES.....	3
2.NOMENCLATURE.....	4
3.INITIAL ASSEMBLY AND INSPECTING.....	5
4.SAFETY BUTTON.....	6
5.LOADING AND USAGE.....	7
6.UNLOADING.....	8
7.DISASSEMBLY.....	9-10
8.REASSEMBLY.....	11-12
9.USE OF CHOKE TUBES.....	13-15
10.PARTS LIST.....	16
11.EXPLODED VIEW.....	17-18
12.CLEANING AND MAINTENANCE.....	19

---

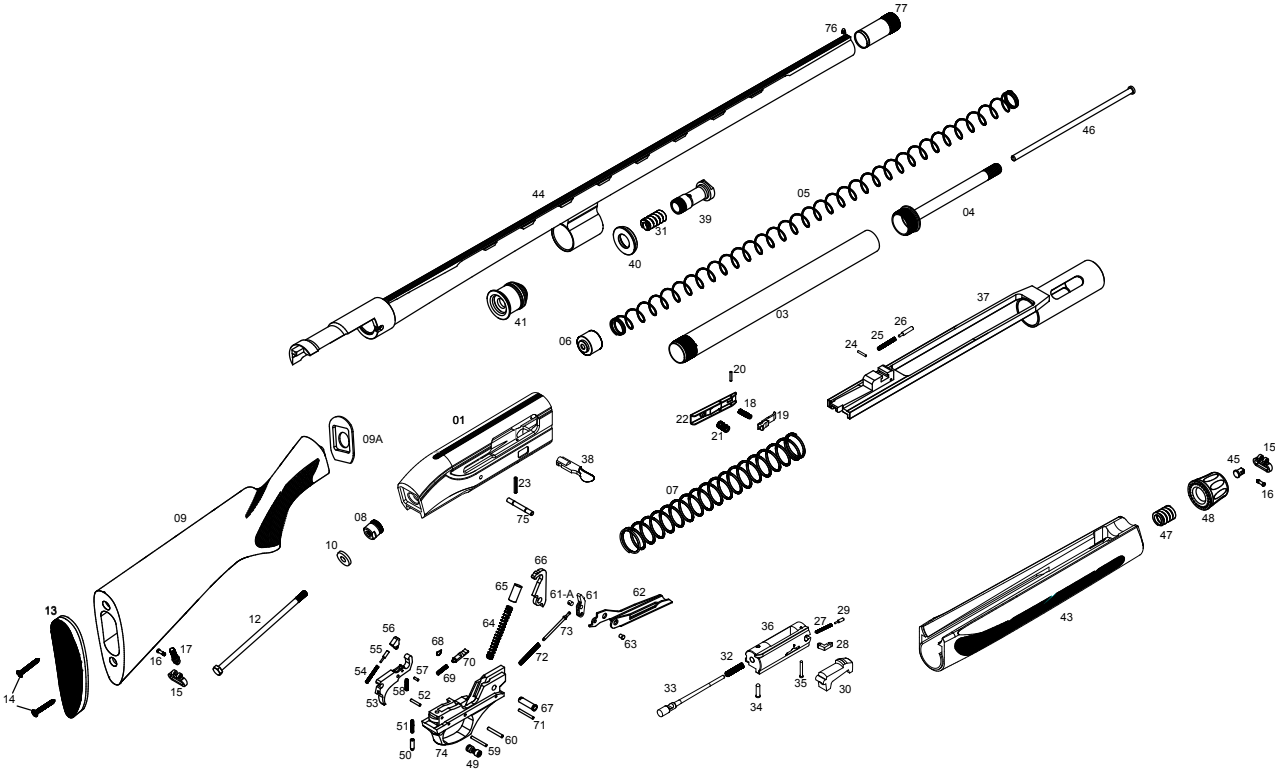

## 12-CLEANING AND MAINTENANCE

**WARNING: ENSURE THAT YOUR FIREARM IS UNLOADED BEFORE BEGINNING TO CLEAN IT.**

At the end of the day of shooting/hunting, clean and lubricate the shotgun.

**Cleaning procedure:**

- Disassemble the shotgun (see paragraph "Disassembly").
- Clean the bores with care by passing a cleaning rod with a cotton patch coated with a high-quality gun oil to remove combustion residues. Also include the chambers in your cleaning operation.
- Do not forget to clean choke tubes and choke threads in the muzzle. Failure to clean these areas will result in the inability to remove the choke from the barrel and severe damage to the muzzle. If a choke tube becomes tight in the muzzle, this is an indication that the thread requires cleaning.
- Run a clean dry patch through the bores to remove oil residues.
- Lightly oil the inside of the barrels with a clean cotton patch coated in high-quality gun oil. Gas piston and chamber should be regularly cleaned, otherwise cycling issues may occur.
- Clean with care the external surfaces of the shotgun to remove any trace of dirt, sweat and fingerprints.
- Make sure you do not touch the metal parts while you are putting your shotgun back into its place of storage.

Always follow the instructions provided with your gun cleaner and gun lubricant. Whenever your firearm has been exposed to sand, dust, extreme humidity water or other adverse conditions, it must be cleaned and lubricated.

After an intensive period of use, check the operation of the bolt assembly and if necessary, clean and lubricate it using suitable gun oil.

If your firearm will be used in a cold climate, be sure to use an oil of an appropriate weight so that it will not congeal in cold temperatures.

NEVER MANIPULATE, ADJUST OR CHANGE ANY OF THE INTERNAL COMPONENTS OF YOUR FIREARM.

ANY MAINTENANCE, ADJUSTMENT OR SERVICE NOT SPECIFIED IN THIS MANUAL MAY AFFECT THE SAFETY AND RELIABILITY OF YOUR FIREARM AND MUST BE PERFORMED BY AN AUTHORIZED GUN-SMITH USING GENUINE FACTORY PARTS.

IF YOU DO OTHERWISE, IMPROPER FUNCTIONING OF YOUR FIREARM MAY OCCUR AND SERIOUS INJURY OR DEATH MAY RESULT.

When storing, do not encase the shotgun in anything that will attract or hold moisture, for example; leather or heavy cloth. Also, do not store shotguns with a plug inserted in the barrel for this can be a contributing factor to moisture accumulation. If the shotgun is to be stored for an extended period, the bore, chamber and internal surfaces should be oiled with a high-quality lubricating oil preservative intended for firearms.

The external parts; receiver, bolt and barrel should be coated with an anti-rust oil.



DICKINSON

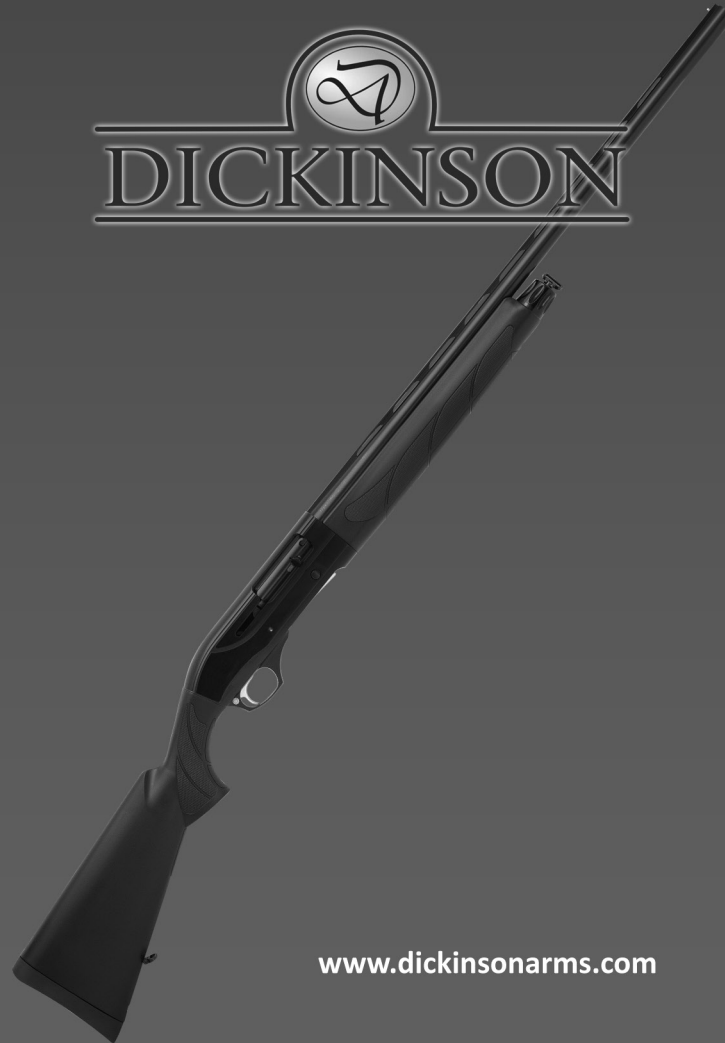

[www.dickinsonarms.com](http://www.dickinsonarms.com)



DICKINSON

**GAS OPERATED  
SEMI-AUTOMATIC MODELS**



**READ THE INSTRUCTIONS AND WARNINGS IN THIS MANUAL  
BEFORE USING THIS SHOTGUN!**