



Trijicon VCOG®



The Trijicon VCOG® (Variable Combat Optical Gunsight) is a highly rugged, illuminated, variable magnification riflescope designed for close-quarter battle (CQB) and long-distance marksmanship. Known for its nearly indestructible design, first focal plane reticle and outstanding glass quality, the VCOG is trusted by the U.S. Military, law enforcement, and 3-Gun competitors to take a beating and maintain zero.

- 1 Virtually indestructible and tested to MIL-STD-810G
- 2 VCOG 1-8x28 Chosen as the U.S. Marine Corps Squad Common Optic (SCO)
- 3 Multi-coated lenses provide superior clarity and light-gathering capabilities with zero distortion
- 4 First focal plane reticle to rapidly acquire target and apply correct hold
- 5 Integrated mounting adapter provides quick and easy mounting to any rail system

The Science of Brilliant®

At Trijicon, we are bound by a commitment to industry-leading research, design, and testing to seek innovative aiming solutions that constantly redefine “brilliant.” That’s why every Trijicon riflescope design is tested to the procedures below.



> Alaska-to-Africa Temperature Tested

To ensure each family of riflescopes is ready for whatever our users put them through, we perform an “Alaska-to-Africa” temperature shock test with temps from -20°F to 140°F.

> Immersion Tested

All models are immersion tested, and every riflescope is dry-nitrogen filled to eliminate internal fogging.

> Solid Zero Tested

Our riflescopes are designed to hold their zero giving you the precision you need. Every model is subjected to 5,000 consecutive rounds, confirming no reticle shift has occurred.

> Shock & Vibration Tested

All riflescope models are tested to withstand recoil and vibrational stresses without malfunction, so it can take a beating before, during, and after use.

> Drop Tested

Because we don’t believe every drop should be followed by a warranty claim, we drop test each riflescope design to check for durability.

To learn more about The Science of Brilliant and Trijicon products, visit Trijicon.com/Science.

Features and Benefits

- A Quick Magnification Adjustments**
Integrated dial fin allows easy rotation through magnification settings.
- B Easy-to-Set Adjusters**
Adjustments are easy and precise—without requiring tools.
- C Adjustable Brightness Settings**
11 brightness settings (1-8x28);
6 brightness settings (1-6x24)
- D Superior Quality Glass**
Multi-coated lenses provide superior clarity and light-gathering capabilities with zero distortion.
- E Rugged & Durable**
Tested to MIL-STD-810G, a series of tests approved by the U.S. Department of Defense to simulate conditions in the field.
- F Waterproof to 20m/66 ft.**
Dry nitrogen-filled to eliminate fogging.
- G Quick, Accurate Ranging Reticles**
1-6x24 offers BDC or Universal MIL and MOA reticles;
1-8x28 offers Universal MRAD and MOA reticles.
- H Easily Mounts to Firearms with Standard Picatinny Rail**
Integrated mounting solution allows the optic to be mounted out of the box. No conventional scope rings needed.

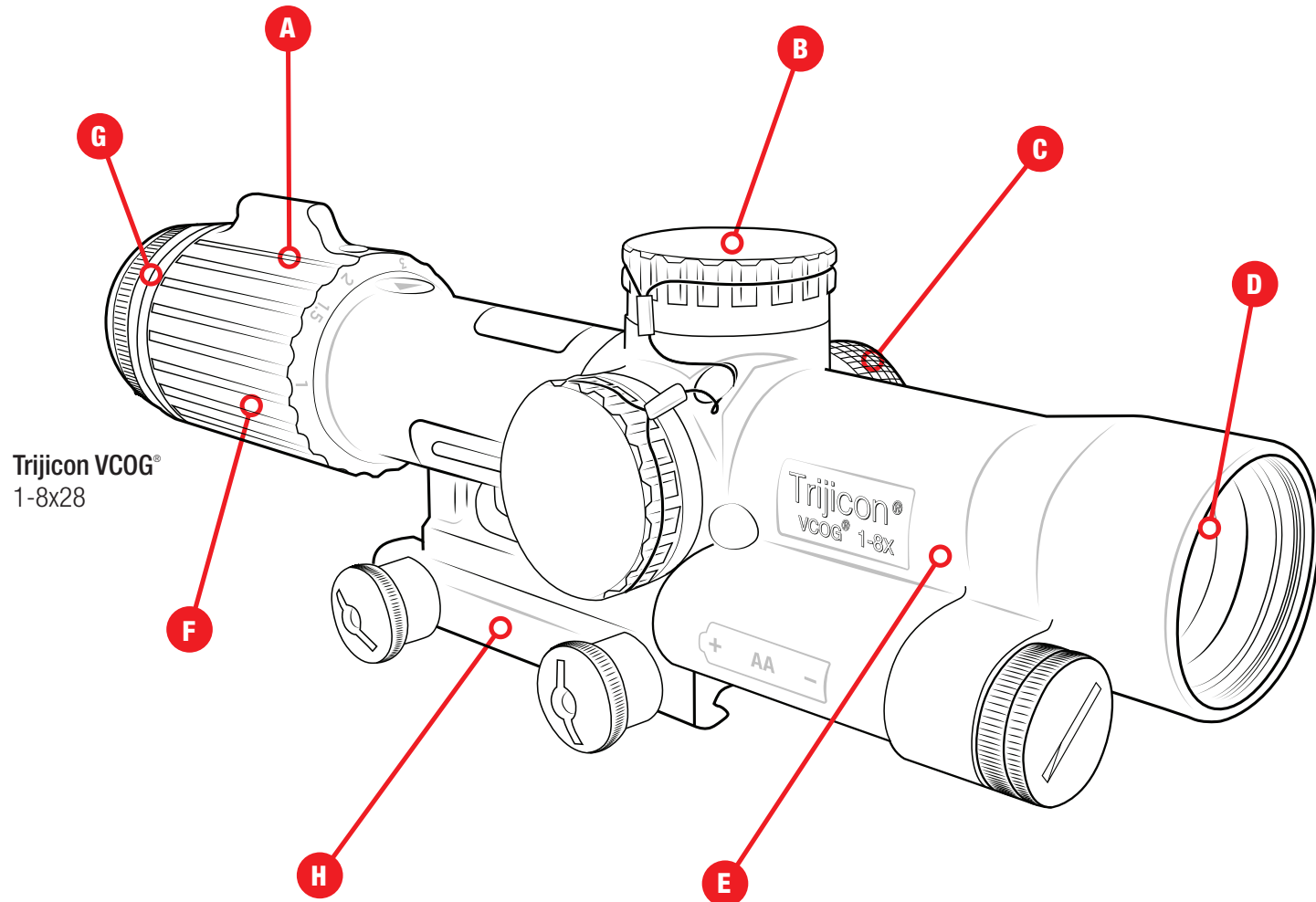

Trijicon VCOG®
1-8x28

Specifications



	1-6x24 (VC16 Series)	1-8x28 (VC18 Series)
Magnification	1 – 6x	1 – 8x
Objective Lens	24mm	28mm
Focal Plane	First	First
Eye Relief	4 in. Constant 101.6mm	4 – 3.9 in. 102 – 99mm
Exit Pupil	0.41 – 0.15 in. 10.4 – 3.8mm	0.46 – 0.15 in. 11.8 – 3.5mm
Field of View (Degrees)	18.0 – 3.0°	20.0 – 2.5°
Adjustments	MOA / MIL 0.25 MOA / 0.1 MIL Per Click	MOA / MRAD 0.25 MOA / 0.1 MRAD Per Click
Adjustment Range (Elevation and Windage)	90 MOA Total Travel (35 MOA Per Revolution)	120 MOA Total Travel (20 MOA Per Revolution)
Dimensions (L x W x H)	10.05 x 2.51 x 2.73 in. 255 x 64 x 69mm	10.8 x 2.8 x 2.8 in. 274.3 x 71.1 x 71.1mm
Weight (with Battery and Mount)	27.0 oz. 765g	31.5 oz. 893g
Illumination Source	LED Powered by a Single Lithium or Alkaline AA Battery	LED Powered by a Single Lithium or Alkaline AA Battery
Battery Life	700 Hours (Red) 1400 Hours (Green) Continuous Use at Brightness Setting 4 of 6* (Lithium Battery)	633 Hours (26.4 Days) Continuous Use at Brightness Setting 6
Brightness Settings	6	11 (including 2 Night Vision, 8 Day, and 1 Super-Bright Setting)

*When used at 70°F (21°C). Extreme temperatures (high or low) will affect lithium battery performance.

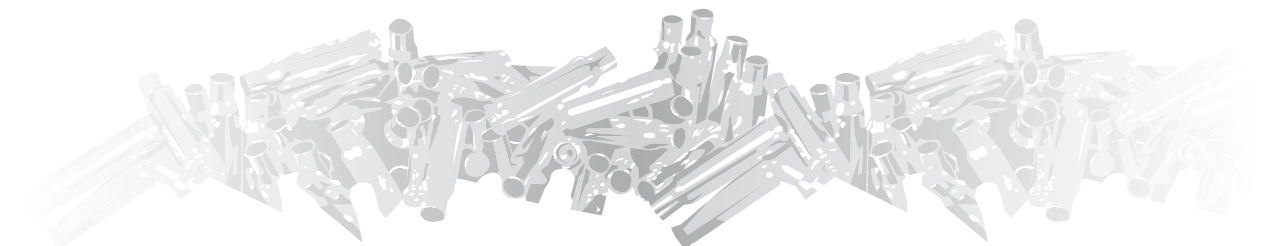

Available Reticle

1-6x24



Segmented Circle Crosshair

Thumbscrew Mount

- VC16-C-1600000 / .223 / 55 Grain
- VC16-C-1600040 / .223 / 55 Grain

- VC16-C-1600001 / .223 / 77 Grain
- VC16-C-1600041 / .223 / 77 Grain

- VC16-C-1600004 / .308 / 175 Grain
- VC16-C-1600044 / .308 / 175 Grain

Quick Release Mount

- VC16-C-1600007 / .223 / 55 Grain
- VC16-C-1600047 / .223 / 55 Grain

- VC16-C-1600008 / .308 / 175 Grain
- VC16-C-1600011 / .308 / 175 Grain

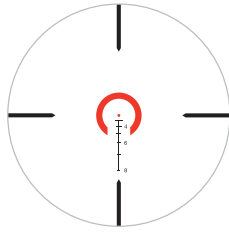

Horseshoe Dot

Thumbscrew Mount

- VC16-C-1600002 / .223 / 55 Grain
- VC16-C-1600042 / .223 / 55 Grain

- VC16-C-1600003 / .223 / 77 Grain
- VC16-C-1600043 / .223 / 77 Grain

- VC16-C-1600005 / .308 / 175 Grain
- VC16-C-1600045 / .308 / 175 Grain

Quick Release Mount

- VC16-C-1600009 / .223 / 55 Grain
- VC16-C-1600049 / .223 / 55 Grain

- VC16-C-1600010 / .223 / 77 Grain
- VC16-C-1600050 / .223 / 77 Grain

- VC16-C-1600012 / .308 / 175 Grain
- VC16-C-1600052 / .308 / 175 Grain

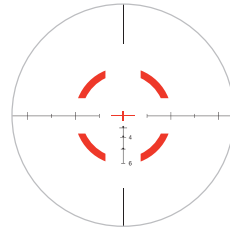

Segmented Circle Crosshair / 300 BLK

Thumbscrew Mount

- VC16-C-1600006 / 300 BLK
- VC16-C-1600046 / 300 BLK

- Quick Release Mount
- VC16-C-1600013 / 300 BLK
 - VC16-C-1600053 / 300 BLK

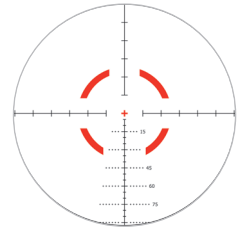

Segmented Circle Crosshair MOA

Thumbscrew Mount

- VC16-C-1600035
- VC16-C-1600036

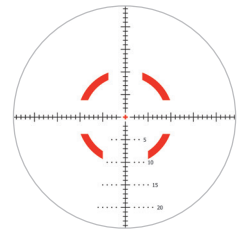

Segmented Circle Crosshair MIL

Thumbscrew Mount

- VC16-C-1600037
- VC16-C-1600038

1-8x28

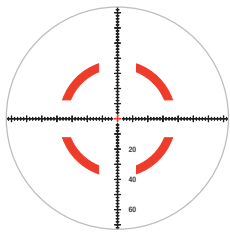

Segmented Circle Cross-Dot MOA

Thumbscrew Mount

- VC18-C-2400001

Q-LOC Mount

- VC18-C-2400013

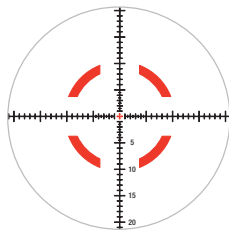

Segmented Circle Cross-Dot MRAD

Thumbscrew Mount

- VC18-C-2400003

Q-LOC Mount

- VC18-C-2400014

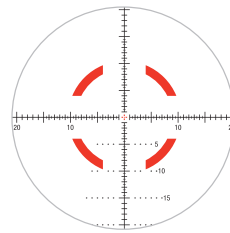

Segmented Circle MRAD Tree

LT799 Quick Release Mount

- VC18-C-2400012

Reticles not shown to scale.

For a full view of the reticle,

please visit our website at

Trijicon.com.



Trijicon.com/VCOG