



ELECTRO-OPTICS

WHISKEY®

HUNTING RIFLESCOPES

OWNERS MANUAL

SIG SAUER®

TABLE OF CONTENTS

Introduction	3
Features	3
Contents	4
Product Identification	4
Operation	6
Illumination Brightness level	8
LevelPlex®	9
Mounting the Sight	10
Sight Adjustments	12
Maintenance	18
Troubleshooting	19
SIG SAUER® Electro-Optics Infinite Guarantee™	20
SIG SAUER Electronic & Tritium Component Limited 5-Year Warranty . .	21

Please visit sigsauer.com for Owners Manual downloads.

INTRODUCTION

SIG SAUER demands the most of their products. The WHISKEY® series riflescope is no exception. Offering maximum light transmission and optical clarity, the WHISKEY riflescope is built to withstand the rigors that modern shooters and hunters require.

FEATURES

- SIG SAUER® Infinite Guarantee™
- SIG SAUER Ballistic Turret (SBT)
- IPX7 Waterproof rating
- European style eyepiece for smooth, fast, and precise reticle adjustment

WHISKEY5™ FEATURES

- HDX High Definition/High Light Transmittance Glass
- 5 times optical zoom
- Hellfire™ Illuminated Reticle (select models)
- LevelPlex® (select models)
- TH100 Turrets (select models)

WHISKEY3™ FEATURES

- LD Low Dispersion Glass
- 3 times optical zoom
- Hellfire™ Illuminated Reticle (select models)

CONTENTS:

- Riflescope
- CR2032 Battery (Illuminated Reticle models)
- Zero-stop adjustment tool (select models)
- Manual

PRODUCT IDENTIFICATION

- A** Objective Lens
- B** Main Tube
- C** Illumination Power Selector Ring/ Parallax Adjustment Ring (select models)
- D** Elevation Dial
- E** Windage Dial
- F** Power Selector Ring
- G** Diopter Adjustment Ring
- H** Ocular Lens

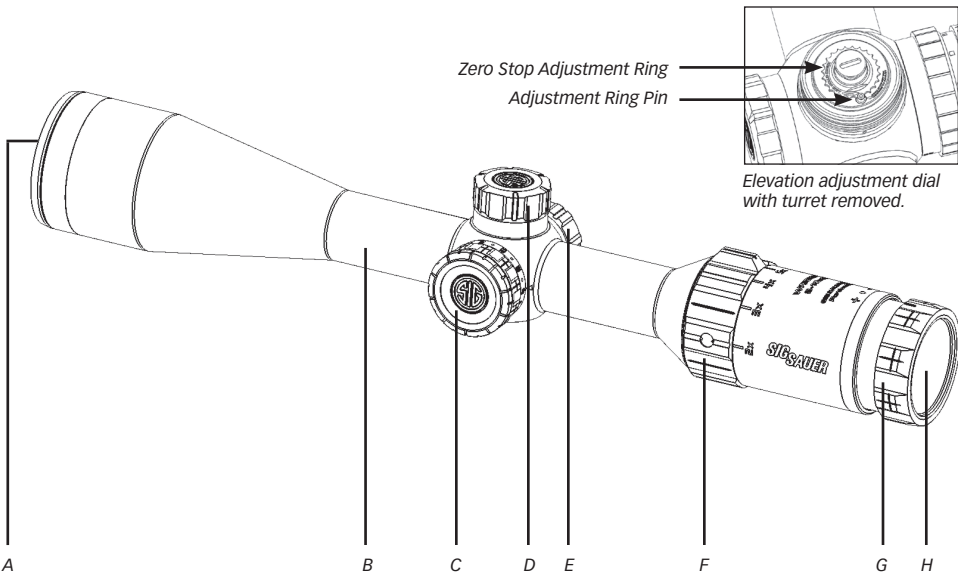

 **WARNING**

Before working on your WHISKEY® riflescope always ensure that the firearm is unloaded with the safety on.

OPERATION**Installing the battery**

Some WHISKEY riflescopes are equipped with illuminated reticles and require CR2032 batteries. To install the battery loosen the battery port cover on the left side of the riflescope turret. Place the battery into the battery port with the plus side facing outward. Screw the battery port cover back onto the left side of the turret.

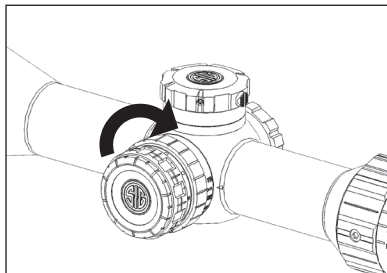
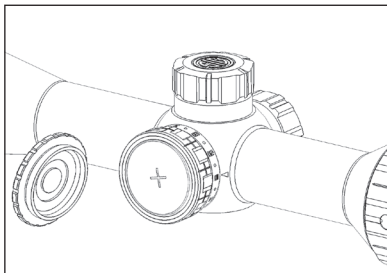
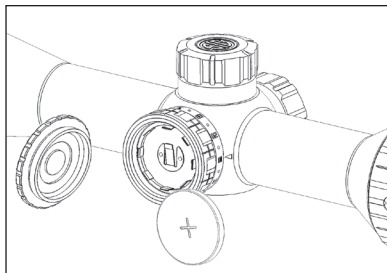
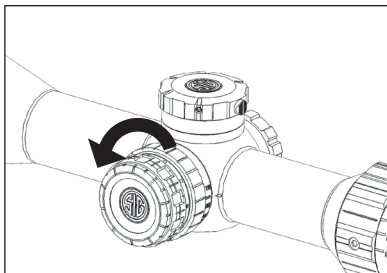

ILLUMINATION BRIGHTNESS LEVEL

- Select the illumination brightness level that suits your conditions the best
- Higher power settings, indicated by larger squares, are better suited for brighter conditions
- Lower power settings, indicated by smaller squares, are better suited for low light conditions
- Brightness level settings alternate between on and off locations. Filled in squares indicate on positions.
- LevelPlex® models only have one off position. The brightness of the LevelPlex indicator correlates to the reticle brightness selected.

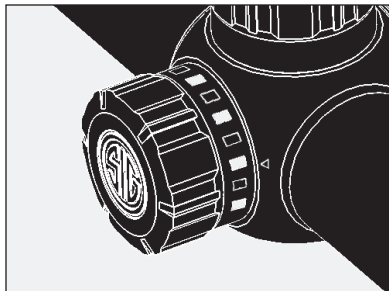

LEVELPLEX[®]

- LevelPlex is a digital anti-cant system. It is used to ensure that your scopes is perfectly level. It is designed to greatly increase long range accuracy. LevelPlex can also be used as an aid in leveling your scope when installing it on your firearm.
- Users can select from 3 different brightness levels and 2 leveling coarseness settings for LevelPlex when they chose to use the system without their reticle illuminated.
- To reach the setting menu select the off position for the reticle illumination and hold the LevelPlex button in for 3 seconds. This beings a round robin menu that will toggle through 3 brightness settings for +/- 0.5° on the left side indicator and 3 brightness settings for +/- 1.0° on the right side indicator (left side will be flashing and the right side will be solid). When you find the setting you desire release the LevelPlex button.
- Once you chose between the fine and coarse LevelPlex setting it will be consistent throughout all reticle illumination settings.

MODE	TILT THRESHOLD	TILT BRIGHTNESS (also shown on indicator LED)	INDICATION DURING ROUND-ROBIN
"Fine"	0.5 degree	low	'LEFT' LED, 3 blinks per second
		med	
		high	
"Coarse"	1.0 degree	low	'RIGHT' LED, solid 'on'
		med	
		high	

Mounting the riflescope

Choose rings and bases that correspond to your firearms action and the diameter of your riflescope's maintube. In order to maintain a comfortable cheek weld always mount your riflescope with the lowest possible ring height. Make sure that there is no interference with any of the moving parts of your firearm.

LevelPlex® can be utilized as a mounting aid. Make sure that your firearm is level and activate LevelPlex. When the indicators show that the scope is level tighten your rings to the appropriate torque.

Set proper eye relief

Slightly loosen the riflescope rings and position the riflescope as far forward as it will mount. For adjustable power riflescopes select the highest possible power. Mount the rifle in a comfortable and repeatable, natural position. Adjust the position of the riflescope backwards until you have maximum field of view in your riflescope.

Ensure that the vertical crosshair of the riflescope matches the vertical centerline of your rifle and tighten the rings and bases to the correct torque

- To turn the illuminated reticle on rotate the illumination power selector ring to the desired level.
- To turn the illuminated reticle off rotate the illumination power selector ring to an empty square.

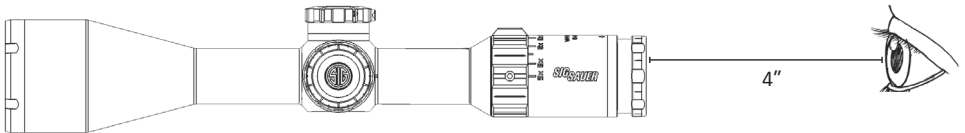

SIGHT ADJUSTMENTS

The riflescope will come optically centered. This should get you close to your rifles zero out of the box.

Focusing the reticle with the diopter

Aim the riflescope at a light object to maximize the contrast of the reticle. Turn the diopter until the reticle comes into focus.

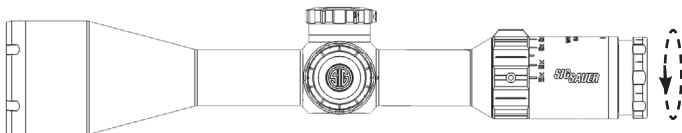

Adjusting Power

WHISKEY® riflescopes are variable power. In order to increase the power setting rotate the power selector ring clockwise. Turn the power selector ring until the image is magnified to the desired range.

Bore sighting

If you are installing the riflescope from other than its factory settings it is best to bore site your riflescope. This will give you a coarse zero and will require further adjustments.

With the rifle in a firm rest, remove the bolt from your rifles action (with AR style rifles remove the rifles upper from its lower assembly and remove the bolt carrier). Look through the rifles barrel from the rear of the rifle and aim it so that your target is centered. Without moving the position of the barrel, use the elevation and windage adjustments of your riflescopes reticle so that it is also in the center of the target.

Parallax Adjustment*

When using your riflescope for longer range targets, parallax can become more noticeable. This can be noticed when it appears that your reticle is moving separate from the target when you move your head/eye from side to side. To adjust parallax rotate the parallax dial clockwise for increased distances. Turn the dial until the parallax is corrected.

*Certain models offer adjustment on the left side of the turret.

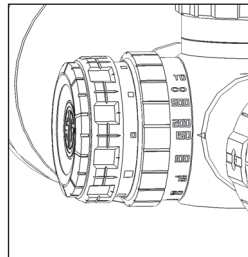

Point of Impact (POI) corrections

POI corrections should be done using the center of a three shot group. If you are not able to get a consistent three shot group then you will need to trouble shoot your rifle further.

If your POI is located to the left of your point of aim (POA) then you need to adjust the windage to the right. The value of each click is marked on your riflescope. To move your POI to the right you will need to turn the windage turret counter-clockwise. To move your POI left turn the windage turret clockwise.

If your POI is located below your POA then you need to adjust your elevation up. The value of each click is marked on your riflescope. To move your POI up you will need to turn the elevation turret counter-clockwise. To move your POI down turn the elevation turret clockwise.

The goal of these adjustments is for your point of impact to match up with your point of aim. You will need to make windage or elevation adjustments in order to accomplish this .

Re-setting your zero - WHISKEY3™

To reset the zero on your WHISKEY3 rifle scope, lift up on the adjustment dial and rotate the dial to zero. Once you are back to zero release the dial. Replace the dial cap.

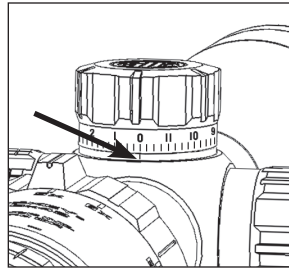
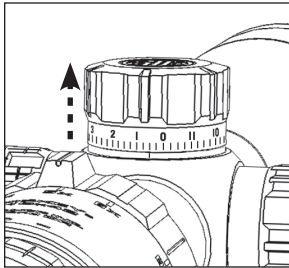

Re-setting your zero - WHISKEY5™

To set the zero stop on your WHISKEY5 scope, remove your adjustment dial, depress the adjustment ring pin, and rotate the zero stop adjustment ring in the counter-clockwise direction until it stops. Use the provided tool if the ring is difficult to rotate. Replace the dial with it set to zero. Tighten the 3 set screws.

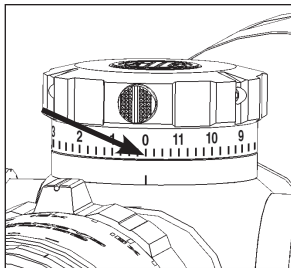
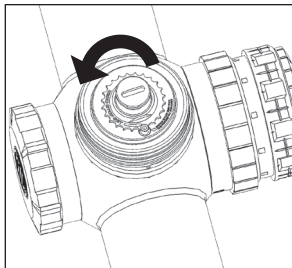

SIG SAUER Ballistic Turret

All WHISKEY® riflescopes are capable of using a customized Sig Ballistic Turret (SBT). Once you provide the required information (caliber, muzzle velocity, bullet/BC, atmospheric information, etc) SIG SAUER can create a custom dial matched specifically to your rifle and cartridge. This dial will take the guess work out of adjusting your riflescope for long range engagements.

Installing SBT Dial

- Remove the elevation cap. The SBT Dial is intended to be used without a cap.
- Remove the existing elevation dial by loosening the set screws securing it to the jack screw.
- Thread the supplied thread cover over the exposed cap threads on the turret.
- Install the new SBT dial. Secure the SBT dial to the jack screw by tightening the set screws.
- SBT Dials re-zero in the same manner as the stock dial.

MAINTENANCE

Your SIG SAUER riflescope requires very low maintenance.

- If your riflescope came with turret caps make sure that they are installed when you are not making windage or elevation adjustments.
- If your riflescope came with an illuminated reticle make sure that you turn the illumination control to one of the off positions when it is not in use.
- If the battery for your illuminated reticle is dead replace it by rotating the illumination battery port cap counter-clockwise. Replace the battery with a new CR2032 battery positive side facing out.
- Keep your lenses clear by using a soft cloth or lens pen. The best way to maintain image quality is by keeping your lenses clear of dirt and dust that cause scratches.

TROUBLESHOOTING

POI changes between groups

- Check that all of your mounts are tightened to the correct torque spec
- Check/Clean your rifle
- Check for variations in ammunition

Illuminated reticle does not work

- Check that the battery is installed correctly
- Replace battery
- Ensure that the illumination power selector ring is in an on position

Reticle Options (Illuminated and Non-Illuminated)

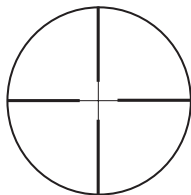

QuadPlex

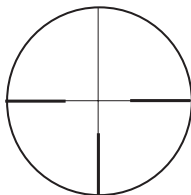

Triplex

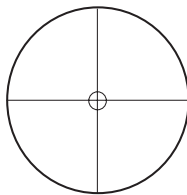

CirclePlex

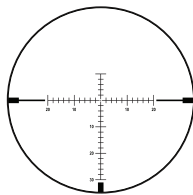

MOA Milling Hunter



SIG SAUER Electro-Optics Infinite Guarantee™

SIG SAUER has manufactured the most rugged, dependable high-performance firearms for over two centuries. Our heritage of design, engineering and precision-manufactured quality predates the existence of any other optics company worldwide. We understand the importance of quality in the line of fire, at the shooting range or on your next hunt. SIG SAUER Electro-Optics had to earn the right to wear that badge and the Infinite Guarantee has your back, forever. Period.

We will repair or replace your SIG SAUER product in the event it becomes damaged or defective, at no charge to you. If we cannot repair your product, we will replace it with a product in perfect working order of equal or better physical condition. It doesn't matter how it happened, whose fault it was, or where you purchased it.

SIG SAUER Infinite Guarantee™

- Unlimited Lifetime Guarantee
- Fully Transferable
- No Warranty Card Required
- No Receipt Required
- No Time Limit Applies
- No Charge

If you ever have a problem, no matter the cause, we promise to take care of you when it counts. Please note that our Infinite Guarantee does not provide coverage for intentional damage, misuse, cosmetic damage that does not affect the performance of the optic, loss, theft or unauthorized repair or modification. Excludes electronic components.



SIG SAUER Electronic & Tritium Component Limited 5-Year Warranty

For components not included under the SIG SAUER® Infinite Guarantee™, this warranty covers any defects in materials and workmanship in the electronic and Tritium components of illuminated riflescopes/sights, pistol sights, electronic sights, flashlights, lasers, binoculars, spotting scopes, and rangefinders. This warranty lasts for five years from the date of manufacture. If, during that five-year period, these products are found to have electronic or Tritium component defects in materials or workmanship, SIG SAUER will repair your product, at no charge to you. If we cannot repair your product, we will replace it with a product in perfect working order of equal or better physical condition.

⚠ WARNING: CANCER AND REPRODUCTIVE HARM – www.P65Warnings.ca.gov



NOTES:



FOR PRODUCT SERVICE ON THIS MODEL, PLEASE CALL 603-610-3000

27100 SW Parkway Ave, Wilsonville, OR 97070 USA