



# ROSSI®

## OWNER'S MANUAL

Single Barrel Shotgun

Single Barrel Rifle

Matched Pair



SCOPE NOT INCLUDED

## GENERAL SAFETY AND OPERATING INSTRUCTIONS

**READ CAREFULLY BEFORE USING YOUR FIREARM**

**Important: Keep this manual with your firearm.**

The information contained in this manual is useful, both for beginners and experienced shooters. In addition to important information about the function, cleaning and care of the firearm, this manual contains instructions that may be very helpful in shooting safely. **The most important rule of safe firearm handling is always keep the muzzle pointed in a safe direction!**

## TO OUR CUSTOMERS

Congratulations on the purchase of your new Rossi firearm. Like any precision instrument, if properly cared for, your Rossi should give you a lifetime of shooting enjoyment. Please take the time to read and understand the warnings and instructions contained in this owner's manual. This manual should be kept with your firearm. Upon change of ownership, transfer this manual with the firearm.

### **WARNING**

Never allow a minor to shoot without adult supervision. Never leave a firearm in the possession of a minor. When shooting with a child, make sure to remain close and safely supervise all activities. Always make sure to store firearms and ammunition separately.

### **NOTICE**

It is recommended that you record the model number, serial number and date of purchase of your Rossi firearm for future reference. Be sure to retain your store receipt and any other documentation that came with your Rossi.

Model Number	
Serial Number	
Date of Purchase	

## TABLE OF CONTENTS

<b>6</b>	Firearm Safety
<b>8</b>	Firearm Safety Systems
<b>11</b>	Firearm Storage and Gun Locks
<b>11</b>	Ammunition
<b>15</b>	Operating Instructions
<b>17</b>	Manual Safety
<b>18</b>	Decocking
<b>19</b>	How to Load Your Firearm
<b>20</b>	Rear and Front Sight
<b>21</b>	How to Fire What to do if Firearm Fails to Fire
<b>21</b>	Unloading Your Firearm
<b>22</b>	Takedown Instructions
<b>22</b>	Changing Barrels
<b>23</b>	Care and Maintenance Repair Instructions
<b>24</b>	Exploded View Parts List
<b>26</b>	Repair Policy

**ROSSI**

ALWAYS KEEP THE MUZZLE POINTED IN A SAFE DIRECTION.

*Intentionally Left Blank*

## NOTES

---



---



---



---

### **⚠ WARNING**

The safety warnings in this booklet are important. By understanding the dangers inherent in the use of any firearm, and by taking the precautions described herein, you can safely enjoy your Rossi® firearm. Failure to follow any of these warnings may result in serious injury to you or others, as well as severe damage to the firearm or other property.

## SIGNAL WORDS AS DEFINED BY ANSI Z535.6 AND Z535.4 STANDARDS.

### **⚠ DANGER**

DANGER indicates a hazardous situation which, if not avoided, will result in death or serious injury.

### **⚠ WARNING**

WARNING indicates a hazardous situation which, if not avoided, could result in death or serious injury.

### **⚠ CAUTION**

CAUTION indicates a hazardous situation which, if not avoided, could result in minor or moderate injury.

### **NOTICE**

NOTICE is used to address practices not related to physical injury.

# ROSSI

ALWAYS KEEP THE MUZZLE POINTED IN A SAFE DIRECTION.

## FIREARM SAFETY

### **WARNING**

When a firearm discharges, the bullet or shot can strike a person, resulting in death or serious bodily injury.

The three basic keys to safe handling of firearms:

1. **KEEP YOUR FINGER OFF THE TRIGGER UNTIL YOU ARE READY TO FIRE.** If you maintain good trigger discipline, it is extremely unlikely the firearm will fire.
2. **KEEP THE MUZZLE POINTED IN A SAFE DIRECTION.** Even if the firearm discharges, if the muzzle is pointed in a safe direction, no one will be injured.
3. **NEVER TRUST ANY SAFETY MECHANISM.** If you adopt the attitude that you will not trust any safety mechanism, you will be vigilant about keeping your finger off the trigger and keeping the muzzle pointed in a safe direction.

### **WARNING**

**KNOW YOUR TARGET.** Never fire at targets at close range. Ricochets can and do cause death or serious bodily injury. What constitutes “close range” depends on many factors including target material, bullet caliber and angle of impact.

**KNOW WHAT IS BEHIND YOUR TARGET.** Unless you are shooting into a bullet trap designed to capture the type of ammunition you are firing, projectiles may pass through the target and strike anyone or anything beyond. Bullets can travel miles.

**ALWAYS WEAR HEARING PROTECTION.** Firearms are loud. The sound they generate is greater indoors. Repeated exposure to loud noises can cause deafness. Hearing protection is rated by decibel reduction. Look for “dB” reduction of 30 or more when purchasing ear protection. Modern ear protection can allow normal hearing until the sound from the discharge reaches the ear. Layering hearing protection, for example wearing 30db rated foam plugs along with 20db rated ear muffs, significant protection can be achieved.

**ALWAYS KEEP THE MUZZLE POINTED IN A SAFE DIRECTION.**

**ALWAYS WEAR EYE PROTECTION.** In normal operation, firearms emit hot high-velocity gases, particles and metal. These materials flying into your eye can cause blindness. Protect your vision with proper eye protection. Any eye protection may be better than none, but look for ANSI Z87.1-2003 certified eyewear for the best protection.

**NEVER HANDLE FIREARMS WHILE UNDER THE INFLUENCE OF DRUGS OR ALCOHOL.** Firearms are dangerous. Handling firearms while impaired by drugs or alcohol is foolhardy and may result in serious injury or death. This warning includes prescription drugs that contain a warning about using machinery or driving while taking the medication.

**MODIFIED FIREARMS ARE DANGEROUS, AND USE CAN RESULT IN SERIOUS INJURY OR DEATH.** “Trigger jobs”, polishing original components or installing aftermarket parts can cause a firearm to function in ways different than intended. Some such work may also be illegal.

**DAMAGED FIREARMS ARE DANGEROUS, AND USE CAN RESULT IN SERIOUS INJURY OR DEATH.** Repairs should always be made by a qualified gunsmith or by a factory-authorized repair site. Work done by those unfamiliar with the design can cause a firearm to function in ways different than intended.

**NEVER ATTEMPT TO DISASSEMBLE OR CLEAN A LOADED FIREARM. DOING SO CAN RESULT IN SERIOUS BODILY INJURY OR DEATH.**

How often have we heard “But it went off while I was cleaning it!” or, “I did not know it was loaded!” or, “It was jammed, and I tried to take it apart!”?

**IF A FIREARM GOES OFF, THERE WAS A ROUND OF AMMUNITION IN THE CHAMBER.** Period. “Clear” (or empty) the firearm of all ammunition before disassembling or cleaning.

As owner of your new Rossi firearm, you are responsible for (1) keeping your finger off the trigger, (2) pointing the muzzle in a safe direction, (3) remove ammunition source from firearm and (4) look in and feeling in the chamber to confirm the firearm is empty. An empty firearm cannot fire.

**ROSSI**

ALWAYS KEEP THE MUZZLE POINTED IN A SAFE DIRECTION.

## FIREARM SAFETY SYSTEMS

Firearms safety is supported by a system. With your firearm the system is made up of the following:

1. **You!** Your involvement in safety cannot be overemphasized. No safety component can keep your finger off the trigger and the muzzle pointed in a safe direction. Also, you are the key to never trusting any of the mechanical parts of the safety system.
  2. **Manual Safety -**  
Always use the manual safety. The manual safety should be all the way in the safe position, not half way or at some other point in its travel. The manual safety should remain in the safe position until ready to fire.
- 
3. **Trigger guard -** This is a physical obstruction that helps prevent unintended pressing of the trigger or trigger safety. Do not modify the trigger guard.
  4. **This Manual -** Rossi intends for you to use this manual to learn about your firearm and to help you use your firearm safety. If you use the manual, you will be a long way toward being a knowledgeable and safe firearms owner.
  5. **Online Resources -** RossiUSA.com hosts a library of videos concerning safety and related issues. This library is being added to and revised. Please visit the site and take advantage of what is available there as part of your education regarding using your Rossi firearm in a safe fashion.



# GET TO KNOW YOUR FIREARM

**FIG 1: TRIGGER LOCK**



TRIGGER LOCK

**FIG 2: LEFT-SIDE**



**ROSSI**

ALWAYS KEEP THE MUZZLE POINTED IN A SAFE DIRECTION.

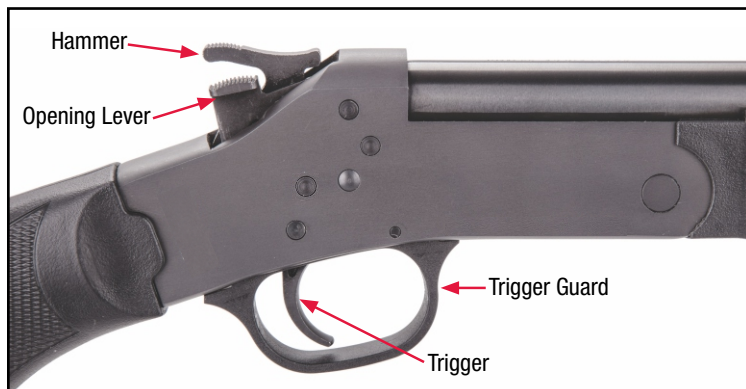
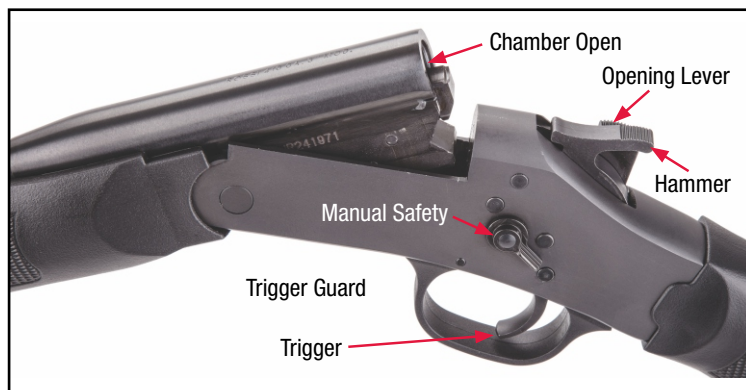
**FIG 3: RIGHT-SIDE****FIG 4: BREAK-OPEN**

## FIREARMS STORAGE AND GUN LOCKS

How you secure your firearms is a personal choice based on the unique circumstances in your home, business or vehicle and the laws of the state where your firearm is located. Any choice you make about securing your firearms will present advantages and disadvantages. It is up to you to weigh those advantages and disadvantages and choose which security method is best for you and those around you.

### WARNING - LOCKING

Never lock a firearm with a round of ammunition in the chamber. Unlocking a loaded firearm makes it more difficult to maintain trigger discipline and to keep the muzzle pointed in a safe direction.

### WARNING

Failure to secure a firearm may result in injury or death. Properly securing a firearm means storing your firearm unloaded, decocked and securely locked, with all ammunition in a separate location.

## AMMUNITION

### WARNING

Using the wrong ammunition in your firearm can result in serious bodily injury and damage to your firearm. Make certain the ammunition you load in the chamber is the same caliber as is marked on the barrel.

# ROSSI

ALWAYS KEEP THE MUZZLE POINTED IN A SAFE DIRECTION.

**WARNING - AMMUNITION AND INDUSTRY STANDARDS**

Use only clean, dry factory-loaded ammunition. Old, damaged, wet or oily ammunition may fire at pressures higher than industry standard, causing injury to you and bystanders or damage to your firearm.

Do not use reloaded ammunition in your firearm. Its firing pressures are unknown and may well exceed industry standard, causing injury to you and bystanders or damage to your firearm.

Odd sounds are signs of trouble. If a round “does not sound right” when it goes off, stop firing right away. A bullet may be stuck in the barrel. Firing the firearm in this condition may cause pressures higher than industry standard, causing injury to you and bystanders or damage to your firearm.

If you hear any odd sounds when firing immediately stop firing. If there is any reason to suspect that the barrel is obstructed, immediately unload the firearm and make clear. Field strip in accordance with procedures listed in this manual. Inspect the bore for blockage with a visual inspection. It is not sufficient to merely look in the chamber. Shot and/or the wad or the bullet may be lodged in the barrel where it cannot be easily seen. If you do not see light when inspecting the bore, it means something is stuck in the bore. Do not fire the firearm again, and take the firearm to a competent gunsmith or contact Rossi Service department at 800-327-3776.

**WARNING**

If the bore is obstructed, DO NOT attempt to shoot it out by using another shot shell or cartridge or by blowing it out with a blank. Such techniques can generate excessive pressure, damage the firearm and cause serious injury.

**WARNING**

“+P” ammunition can be dangerous. There is a detailed discussion about “+P” and “+P+” ammunition on page 13 of this manual. Until you have read that information, do not fire any ammunition marked “+P” in your firearm.

## **WARNING**

Never fire ammunition marked “+P+” in your firearm. It does not comply with industry standards as to chamber pressures.

There are only four calibers that can carry a “+P” rating from SAAMI. They are 38 Special +P, 9mm Luger +P, 38 Super Automatic and 45 Automatic +P. There are no other SAAMI approved “+P” loads. Any ammunition in any other caliber marked “+P” is not SAAMI compliant, may be dangerous and should not be used.

## **NOTICE**

Even if your Rossi firearm is rated for Plus-P (“+P”) ammunition, such ammunition generates pressures significantly in excess of the pressures associated with standard ammunition. Such pressures may affect the useful life of the firearm or exceed the margin of safety built into many firearms. Unless you need +P ammunition, do not use it, particularly for practice.

## **WARNING - LEAD EXPOSURE**

Discharging firearms in poorly ventilated areas, cleaning firearms or handling ammunition may result in exposure to lead and other substances known to the state of California to cause birth defects, reproductive harm and other serious physical injury. Have adequate ventilation at all times. Wash hands thoroughly after exposure with soap and cold water.

### **SHOOTING OR CLEANING GUNS MAY EXPOSE YOU TO LEAD**

The use of reloaded, “remanufactured”, hand-loaded, or other nonstandard ammunition voids all warranties. Improperly loaded ammunition voids all warranties. Improperly loaded ammunition can be extremely dangerous. Severe damage to the firearm and serious injury to the shooter or to others may result. Always use ammunition that complies with the industry performance standards established by the Sporting Arms and Ammunition Manufacturers Institute, Inc., of the United States, (SAAMI) or the equivalent from other countries.

# **ROSSI**

**ALWAYS KEEP THE MUZZLE POINTED IN A SAFE DIRECTION.**

## NOTICE

Shot, wads and bullets can become lodged in the barrel. If the shot shell or cartridge has been improperly loaded without propellant powder, or if the powder fails to ignite (ignition of the shot shell or cartridge primer alone will push the shot and wad or bullet out of the shot shell or cartridge case, but usually does not generate sufficient energy to expel them completely from the barrel).

## NOTICE

Dirt, corrosion, or other foreign matter on a shot shell or cartridge can impede complete chambering and may cause the shot shell or cartridge to burst upon firing. The same is true of shot shells or cartridges which are damaged or deformed.

## WARNING

Do not oil shot shells or cartridges, and be sure to wipe the chamber clean of any oil or preservative before commencing to shoot. Oil interferes with the friction between shot shell or cartridge case and chamber wall that is necessary for safe functioning, and subjects the firearm to stress similar to that imposed by excessive pressure.

## WARNING - SLUG USE

The use of slugs are **unsafe** to use in anything with a front sight bead (permanent modified choke). Any firearm that has the ability to shoot slugs will state such, such as the slug gun or the turkey gun (with the appropriate choke). Other than these two, slugs are unsafe.

## NOTICE - STEEL SHOT USE

Steel shot is abusive and is **not recommended** for continuous usage as it can cause premature wear on the fixed modified choke, or removable choke if used in the turkey gun.

## OPERATING INSTRUCTION

1. These firearms have a “transfer bar” firing mechanism. This means that when the hammer is in the fully forward (rest) position, and the trigger is released, there is no mechanical contact between the face of the hammer and the rear of the firing pin.
2. When carrying the firearm, the safety lever should be “on” and the hammer fully forward in the (rest) position.
3. When the hammer is manually pulled back to its rearmost position (full cock), the transfer bar moves up and is positioned between the face of the hammer and the firing pin. When the trigger is pulled the hammer face strikes the transfer bar which strikes the firing pin which fire the shot shell or cartridge. When the trigger is released, the transfer bar drops down leaving a space between the face of the hammer and the rear face of the firing pin.



### **⚠ WARNING**

These firearms are designed so that the barrel and chamber cannot be either opened or closed when the firearm is fully cocked. Attempting to force the chamber open or closed will damage your firearm and may result in accidental death or serious injury.

### **⚠ WARNING**

The rifle barrel of those models of this product that are so marked is chambered for the .22 Long Rifle cartridge only! Do not attempt to load .22 Short or any other rimfire or centerfire ammunition in the chamber. Failure to heed this warning is a misuse of the product and can result in a variety of malfunctions, some of which can result in serious personal injury or death.

# ROSSI

ALWAYS KEEP THE MUZZLE POINTED IN A SAFE DIRECTION.

## WARNING

Rifle barrels marked for .22 LR (.22 Long Rifle) are chamber for the .22 Long Rifle cartridge. Use only 22 Long Rifle ammunition in good condition - inspect for damage before use.

## WARNING

Always be sure the breech is fully open before inserting a cartridge. Attempting to insert a cartridge in a partially opened breech may create a hazardous situation and can result in serious injury or death.

If you experience a problem loading or unloading the rifle barrel, ***or if the rim of the cartridge slips behind the extractor*** do not attempt to close the gun or it may fire resulting in serious personal injury or death.

1. **If a live round is stuck in the barrel:** Keep the muzzle pointed in a safe direction. Take extreme care to insure that nothing strikes or comes in contact with any portion of the shell casing.
2. **If a fired shell casing is stuck in the barrel:** With the muzzle pointed in a safe direction, press down on the opening lever and pull down the barrel (see page 19). While staying clear of the muzzle, drop a .22 caliber cleaning rod down the barrel. The shell casing should drop free. If not, repeat the process. Take care not to damage the barrel. If the shell casing remains stuck, it should be removed by a reputable gunsmith.

## WARNING

If the shell casing is struck or moved, the primer may ignite firing the cartridge, resulting in serious personal injury or death. Take the shotgun/rifle to a gunsmith to remove the jammed shell casing.

3. **If a cartridge is stuck in the barrel and you are unsure if it fired or not:** Keep the muzzle pointed in a safe direction. Treat it as a live round and handle in accordance with “WHAT TO DO IF FIREARM FAILS TO FIRE” ON PAGE 21



## WARNING

The danger of personal injury or death associated with cartridges, fired or unfired, becoming stuck in a firearm can be avoided by using new, clean, factory loaded ammunition and never forcing ammunition into a chamber. If you have to force ammunition into the chamber, something is wrong! Stop! And take the rifle to a qualified gunsmith.

## WARNING - ANY GUN MAY FIRE IF DROPPED

If dropped or struck, the firearm may fire.

## WARNING

If dropped or struck the firearm should be inspected by a trained armorer/gunsmith for a complete function check. After the firearm was dropped or struck, mechanisms, including automatic safeties, may not function as intended resulting in accidental death or serious injury.

## MANUAL SAFETY

**These firearms are manufactured with a manual safety - USE IT!**

1. The safety lever can be rotated clockwise to the “SAFE” position when the hammer is in any position. The safe position will cover the red dot completely.
2. The manual safety can be disengaged with the hammer in the full cock position by rotating the manual safety lever counter-clockwise to the position where it covers the green S and exposes the red dot.

# ROSSI

ALWAYS KEEP THE MUZZLE POINTED IN A SAFE DIRECTION.

IF THE SAFETY LEVER LOOKS LIKE IMAGE 'A', THE SAFETY LEVER CAN BE ROTATED COUNTER-CLOCKWISE TO THE SAFE POSITION WHEN THE HAMMER IS IN THE REARMOST FULLY COCKED POSITION OR IS PULLED TO THE REAR ABOUT 1/2". NOTE: IN THIS POSITION, (HAMMER DOWN, SAFETY ON), THE ACTION CAN BE OPENED AND CLOSED.



IF THE SAFETY LEVER LOOKS LIKE IMAGE 'B', THE SAFETY LEVER CAN BE ROTATED COUNTER-CLOCKWISE TO THE SAFE POSITION WHEN THE HAMMER IS IN ANY POSITION.



**Fully Cocked**  
Safety On



**"Intercept" Position**  
Safety On



**"Rest" Position**  
Fully Forward Hammer  
Safety is in "OFF" position

## DE-COCKING

If the firearm is fully cocked and the user desires to place the hammer in the rest position, then the hammer must be under full control of the user.

KEEP THE MUZZLE POINTED IN A SAFE DIRECTION. PUT THE SAFETY LEVER ON. WHILE CAREFULLY HOLDING AND CONTROLLING THE HAMMER WITH THE THUMB, PULL THE TRIGGER, SLOWLY AND CAREFULLY LET THE HAMMER MOVE FORWARD APPROXIMATELY 1/2" AND RELEASE THE TRIGGER. CONTINUE TO LET THE HAMMER DOWN UNTIL IT IS RESTING ON THE MANUAL SAFETY INTERCEPT.

ALWAYS KEEP THE MUZZLE POINTED IN A SAFE DIRECTION.

## ⚠ WARNING

You should practice this method with an empty firearm until you are completely familiar and comfortable with this procedure.

## HOW TO LOAD YOUR FIREARM

### ⚠ WARNING

Before loading this or any firearm, always check the bore to be sure it is free of grease, oil or any other obstruction. **BE SURE** the chamber is empty and the entire barrel is clear. Open the breech and visually check the full length of the barrel for any obstruction. Failure to do so may damage your firearm and can result in accidental death or serious injury.

### ⚠ WARNING

Do not rely on the color of a shotgun shell to determine gauge or bore. Always check the box and the headstamp of the actual shell **BEFORE** loading. Failure to do so may damage your firearm and can result in accidental death or serious injury.

1. With the muzzle pointed in a safe direction, with the safety "ON", press down on the opening lever (see page 10 figure 3), and pull down the barrel.
2. Insert the appropriate gauge shot shell or cartridge in the chamber. The appropriate gauge shot shell or cartridge is marked on the barrel.
3. Lift up on the barrel which will close into the receiver.

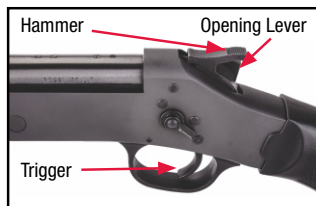

Chamber Open

# ROSSI

ALWAYS KEEP THE MUZZLE POINTED IN A SAFE DIRECTION.

## ⚠ WARNING

When opening the chamber make sure the chamber is pointed in a safe direction. Cartridges and shells ejecting from the chamber can cause injury. ALWAYS INSPECT THE CHAMBER, BARREL AND BORE VISUALLY TO MAKE SURE THEY ARE EMPTY.

## REAR SIGHT

**Elevation Adjustment:** To raise the rear sight, turn the elevation nut counterclockwise. To lower the rear sight, turn it clockwise.

**Windage Adjustment:** The rear sight should be moved in the same direction that you want the point of impact to move. Thus, to dislocate the point of impact to the right, turn the windage correction screw clockwise.

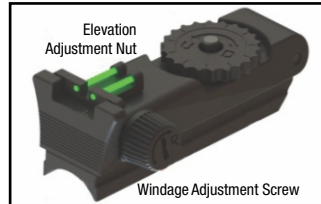

Rear Sight

## FRONT SIGHT

**Disassembly:** To disassemble the front sight first slide the front sight hood forward until it comes off completely from its housing. Next drift out the front sight by pushing it from left to right.

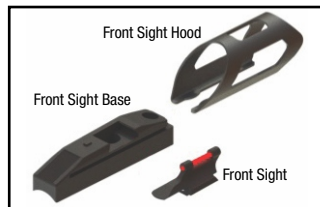

Front Sight

**Assembly:** To assemble the front sight device put together in reverse order. First install the front sight pushing it's from right to left until the end of path. Next adjust the lower tabs of front sight hood into the slots located on the muzzle break side and push it until the end of path, which is fixed by pressure.

## HOW TO FIRE

### **⚠ WARNING**

Always be sure the firearm is pointed at the target and away from other people, buildings and vehicles before firing. Do not fire into water.

1. With the muzzle pointed at the target, with your thumb pull the hammer back to the full-cock position.
2. With the hammer in the full cock position disengage the safety by rotating the manual safety lever clockwise to the position where it exposes the red dot.
3. Pull the trigger to fire.



## WHAT TO DO IF FIREARM FAILS TO FIRE

1. Misfires - If you squeeze the trigger and the shot shell or cartridge does not fire, remain in the shooting position and wait 30 seconds. Then, open the firearm as previously described. This will eject the misfired shot shell or cartridge from the gun.
2. Underpowered Shot Shell or Cartridge - An underpowered shot shell or cartridge is unusual if the ammunition is fresh, clean, and factory loaded. However, if you hear an unusual sound or low report, you should stop immediately, wait a full 30 seconds and check, visually, both the chamber and bore to make sure that there is no obstruction.

## UNLOADING YOUR FIREARM

To unload the firearm, press down on the top lever and pull down on the barrel. This will cause the fired or unfired shot shell or cartridge to be ejected from the chamber. Rimfire cartridges and shot shells will fully eject from the firearm, while centerfire cartridges will be partially extracted and need to be removed by hand.

**ROSSI**

ALWAYS KEEP THE MUZZLE POINTED IN A SAFE DIRECTION.

## TAKE DOWN INSTRUCTIONS

If you wish to “take down” your firearm for transport or storage, proceed as follows:

1. Make sure firearm is unloaded.
2. Unscrew, counter clockwise, the forward sling swivel until it is not engaged in the barrel, then pull forearm down and forward from barrel and receiver assembly. Press the opening lever down and pull barrel down and then back out of receiver.
3. Reassemble in reverse order.

Use a very thin coat of light oil during below freezing conditions. Condensation droplets will form soon after the firearm is brought into a warm room, or it may become wet during inclement weather. In any case, all moisture should be removed. Exterior metal finishes may be wiped down with a slightly oiled cloth. For long term storage, lightly oil the bore, barrel and action with gun oil. Your firearm should be completely unloaded and stored in a dry area. Never store your firearm in a carrying case.

## TO CHANGE BARRELS

1. If you wish to change barrels, follow steps set out above in “Take Down Instructions.” Reassemble with preferred barrel.

### NOTICE

Do not over-tighten the rear sight set screw. Over-tightening the set screw can damage the sight and may render it inoperable.

### WARNING

Further disassembly of the firearm is not recommended and should only be attempted by a qualified gunsmith.

## CARE AND MAINTENANCE

### **WARNING**

Before cleaning. (1) point the muzzle in a safe direction, (2) keep your finger off the trigger, (3) rotate the manual safety lever counter clockwise to the position where it covers the red dot, (4) press down on the opening lever and pull down on the barrel, visually inspect the chamber barrel and bore to ensure firearm is free and clear and safe to preform cleaning.

In order to keep a firearm safe to use, it must be kept clean and covered with a light film of good quality oil to prevent corrosion. The barrel bore should be cleaned and left free of debris.

For normal cleaning, rub it with a lightly oiled cloth. In the same way, proceed with the bore of the barrel. Excess oil should be removed. Dust should be removed from all crevices with a small clean brush.

## REPAIR INSTRUCTIONS

Your firearm has been designed, engineered and manufactured in accordance with Rossi's rigid quality control standards. However, any mechanical device may occasionally require adjustment or repair.

All firearms require periodic maintenance and inspection which may reveal a need for adjustment or repair. Have your firearm checked by a competent gunsmith annually, even if it seems to be working well, since breakage, improper functioning, undue wear, or corrosion of some components may not be apparent from external examination. If you notice ANY mechanical malfunction, do NOT continue to use the firearm. UNLOAD the firearm and take it to a competent gunsmith immediately.

# ROSSI

ALWAYS KEEP THE MUZZLE POINTED IN A SAFE DIRECTION.

## DRAWING AND PARTS LIST

This is intended as a generic guide and not a specific model or guide to assembly.

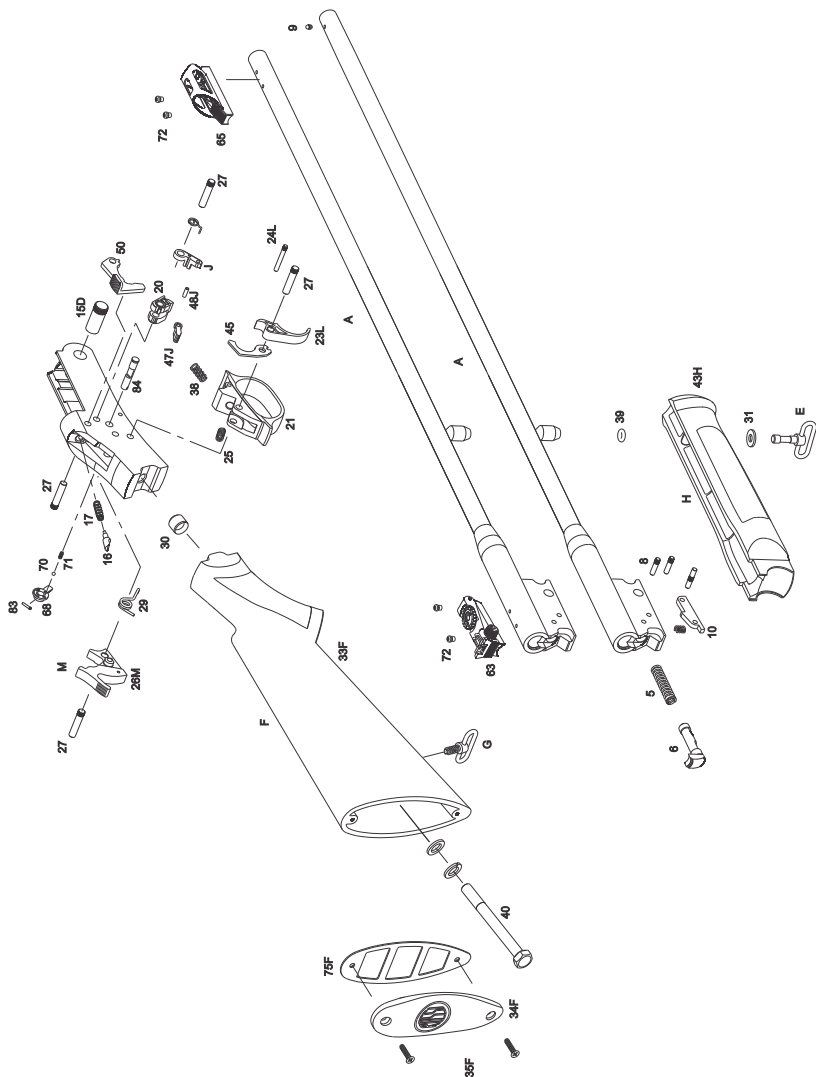

ALWAYS KEEP THE MUZZLE POINTED IN A SAFE DIRECTION.



A .....	Barrel	34-F .....	Butt Plate
E.....	Forearm Assembly Screw	35-F .....	Butt Plate Screw
F.....	Stock Assembly	38.....	Locking Plate Spring
G .....	Lower Swivel	39.....	O-Ring
H .....	Forearm Assembly	40.....	Stock/Receiver Screw
J.....	Transfer Bar Assembly	42-H.....	Cap Locking Screw
L.....	Trigger Assembly	43-H.....	Forearm
M.....	Hammer Assembly	44-H.....	Forearm Cap
5 .....	Extractor Spring	45.....	Trigger Lever
6.....	Extractor	46-J .....	Transfer Bar Lever
8.....	Extractor Stop Pin	47-J .....	Transfer Bar
9.....	Front Sight	48-J .....	Transfer Bar Pin
10.....	Extractor Lever	50.....	Opening Lever
15-D.....	Barrel Pin	52.....	Trigger Guard Pin
16 .....	Firing Pin	62.....	Rear Sight Screw
17.....	Firing Pin Spring	63.....	Rear Sight
20.....	Locking Plate	64.....	Front Sight Base Screw
21.....	Trigger Guard	65.....	Front Sight
23-L .....	Trigger	66.....	Front Sight Screw
24-L .....	Trigger Lever Pin	68.....	Safety Lever
25.....	Trigger Spring	69-D.....	Safety Stop Pin
26-M .....	Hammer	70.....	Safety Locking Ball
27.....	Receiver Assembly Pin	71.....	Safety Locking Spring
28-M .....	Hammer Spring Pin	72.....	Cap Screw
29.....	Hammer Spring	75-F .....	White Spacer
30.....	Stock Assembly Bushing	83.....	Safety Pin
31.....	Forearm Assembly Nut	84.....	Safety Rod
33-F .....	Stock		

# ROSSI

ALWAYS KEEP THE MUZZLE POINTED IN A SAFE DIRECTION.

## PARTS

Our Service Department maintains a full complement of replacement parts for our firearms of current manufacture. Even though most gunsmiths have the knowledge, training and ability to make the necessary repairs to your firearm, the skill and workmanship of any particular gunsmith is totally beyond our control. Should your firearm ever require service, we strongly recommend that you return it to BrazTech. Follow the instructions outlined on the warranty card included with your firearm. Remember, unauthorized adjustments or parts replacement can void your warranty. It is the responsibility of the purchaser to be absolutely certain that any parts ordered from BrazTech are of the correct type and are properly fitted and installed by a competent person.

THIS FIREARM IS A PRECISION MECHANISM AND THE IMPROPER FITTING OF PARTS OR IMPROPER MECHANICAL ADJUSTMENT MAY RESULT IN A DANGEROUS MALFUNCTION, DAMAGE TO THE FIREARM, AND POSSIBLE SERIOUS INJURY TO THE SHOOTER OR TO OTHERS. Therefore, the purchaser and/or installer of parts must accept full responsibility for the correct adjustment of and function of the firearm after such installation has been made or attempted.

## ROSSI LONG GUN REPAIR POLICY

What does this policy cover?

This policy covers any service and repair needed by any product manufactured by Rossi, and imported by Braztech, Int'l. or manufactured in the United States by Braztech, Int'l.

How long does coverage last?

This policy is in effect for one year from the date of original purchase.

**Please note you must complete and return the card in this manual within 3 months of purchase for this policy to be in effect.**

What will we do?

BrazTech will service and/or repair all covered products free of charge.

## What does this policy not cover?

This policy does not cover stock and forend, sights, accessories, or cosmetic defects, or damage caused by customer abuse at any time. Modifications to the firearm may void this repair policy. This express limited repair policy is the only warranty on this product. This product is sold "as is" and has no implied warranties of merchantability or fitness for a particular purpose. There are no warranties which extend beyond the description on the face hereof.

## How do I get service?

To simplify repair and service, Rossi products imported by Braztech International are serviced and repaired by Braztech. Questions regarding the products of either company can be directed to Braztech in Bainbridge, Georgia at 800-948-8029, or in writing to: **C/O Consumer Affairs Department, 100 Taurus Way Bainbridge, GA 39817**

In order to obtain service or repair, describe the problem in writing and send the gun to Braztech at the above address, insured and pre-paid with the written description of the problem enclosed and the receipt indicating the initial date of purchase. Be sure to include physical return address.

**FIREARMS MUST BE SHIPPED UNLOADED.** Double check the chamber of your firearm before shipping. If firearms are sent to BrazTech in a loaded condition, we are required by law to notify the Federal authorities. **DO NOT INCLUDE AMMUNITION** with your firearm. This is a violation of federal law.

**DO NOT** include telescopic sights; custom grips, holsters, ammunition or other accessories with any firearm shipped to us.

When shipping Matched Pair or Matched Set models for repair, all barrels must be included with the firearm. Be sure to repackage the additional barrels in their shipping tubes to prevent damage to the finish and to the stocks during shipment. BrazTech is not responsible for shipment damage.

Our Customer Service Department will contact you by mail advising you when to expect your gun back. We will ship guns serviced because of defect in materials or workmanship insured and pre-paid. There will, of course, be no charge for parts or labor if the repair work performed is covered by this repair policy.

## How does state law apply?

This policy gives you specific legal rights and you may also have other rights which vary from state to state.

**ROSSI**

ALWAYS KEEP THE MUZZLE POINTED IN A SAFE DIRECTION.

## NOTES

A series of 12 horizontal grey bars, stacked vertically, intended for taking notes. Each bar is a solid light grey color and spans most of the width of the page.

## NOTES

A series of 12 horizontal grey bars, stacked vertically, intended for taking notes. Each bar is a solid light grey color and spans most of the width of the page.



**ROSSI**

ALWAYS KEEP THE MUZZLE POINTED IN A SAFE DIRECTION.

## NOTES

A series of 12 horizontal grey bars, stacked vertically, intended for taking notes. Each bar is a solid light grey color and spans most of the width of the page.



**ROSSI**

ALWAYS KEEP THE MUZZLE POINTED IN A SAFE DIRECTION.



## A WORD TO THE WISE

Most gun accidents happen because the shooter carelessly violates the single most important rule of safe gun handling: **Always keep the muzzle pointed in a safe direction!**

Important: **Do not discard.** keep this manual with your firearm. Upon change of ownership, transfer this manual with the firearm.



[WWW.ROSSIUSA.COM](http://WWW.ROSSIUSA.COM)

© Copyright 2017 Braztech International, L.C.  
Rossi is a registered mark of Amadeo Rossi, S.A.

The information in this manual is provided as guidelines and directions for the safe use of your firearm. Braztech and/or Rossi cannot be held responsible for the misuse, illegal or negligent use of our products.

We strongly encourage all firearms owners to observe all firearms safety rules.

**WARNING:** This product contains chemicals known to the State of California to cause cancer, or birth defects or other reproductive harm.

Keep this and all firearms and ammunition away from unsupervised children. Firearms safety is everyone's responsibility.

**Read Carefully Before Using Your Firearm**

Part Number: MKG50054