



LEUPOLD[®]

**TACTICAL RIFLESCOPE
USERS MANUAL**

TABLE OF CONTENTS

Know Your Scope	1
How to Install the Scope	3
How to Sight-In	7
Making Precise Windage And Elevation Adjustments.	9
What You Should Know About Variable Power Scopes	21
Using the Illumination.	22
Changing the Battery.	25
Leupold Means Minimal Maintenance	27
Leupold Product Service	29

KNOW YOUR SCOPE

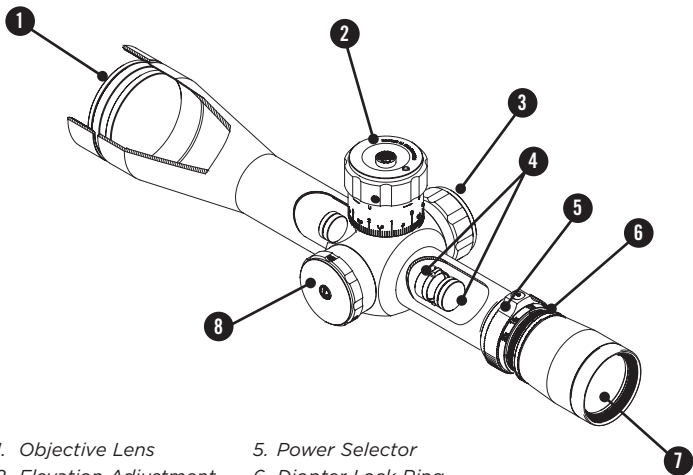

1. Objective Lens

2. Elevation Adjustment

3. Windage Adjustment

4. Erector Lenses

5. Power Selector

6. Diopter Lock Ring

7. Ocular Lens

8. Side Focus Adjustment

Riflescopes have become far more sophisticated over the years, but the four most basic parts have remained the same. Working from front to back they are:

1. The objective lens (or front lens) is critical to a superior sight picture.
2. The reticle, often referred to as the crosshair, provides the aiming point.
3. The internal erector lenses which rights the image.
4. The ocular lens (or eyepiece lens) works with the other lenses to magnify the image, provide correct eye relief, and make diopter corrections.

HOW SCOPES WORK

As light passes through and beyond the objective lens, the resulting upside down image is sent to the internal lenses. Known as erector lenses, these internal lenses return the image to a right-side-up position. Finally, the ocular lens makes a final enlargement of that image and sends it on to your eye. Your Leupold scope was designed, manufactured, and tested to ensure that, when properly mounted and sighted-in on your firearm, you will enjoy exceptional performance. A solid mount is critical to satisfactory performance of your scope. If you have

problems or questions, please contact Leupold Product Service (see page 29).

HOW TO INSTALL THE SCOPE

THE LOWER THE SCOPE, THE BETTER

A scope mounted close to the rifle ensures proper cheek weld on the stock for a stable firing position and allows for rapid target acquisition. We recommend using the lowest possible ring height. No specific clearance is required, but the scope must clear the bolt handle, hammer (on lever actions and handguns), sights, and barrel. When installed, be sure that your scope does not interfere with firearm operation and does not contact anything except the mount rings.

INSTALLING THE BASE, RINGS, AND SCOPE

Please refer to the instructions included with the base and rings for their proper installation on the firearm.

NOTE: The windage and elevation adjustments on new Leupold scopes are centered as part of the assembly process. If you are mounting a scope that was previously mounted on another rifle, you should center the adjustments (please see CENTERING WINDAGE AND ELEVATION ADJUSTMENTS TO ACHIEVE OPTIMUM ADJUSTMENT TRAVEL ON PAGE 20).

ESTABLISHING EYE RELIEF

Because of the safety considerations associated with proper eye relief, Leupold strongly recommends that you mount your scope as far forward as possible. Beyond that, follow these steps:

1. With the scope as far forward in the mounts as possible, hold the rifle in your normal shooting position (Variable power scopes should be set at the highest magnification for this process).
2. Slowly move the scope to the rear just until you can see a full sight picture.
3. Position your scope here for maximum eye relief.
4. Proceed to COMPLETING THE INSTALLATION.

NOTE: To confirm that your scope is mounted in the best possible position, try assuming various positions: kneeling, seated, prone, and aiming both uphill and downhill. Remember that aiming uphill typically reduces eye relief. Wearing hunting/shooting specific clothing is recommended as this may alter eye relief considerations slightly.

COMPLETING THE INSTALLATION

1. Without disturbing the optimal eye relief position, rotate the scope until the elevation adjustment dial is at the top of the scope.

2. From a firing position, check to be sure that the vertical hair of the reticle aligns with the vertical axis of the firearm. Use of a leveling kit is recommended
3. Tighten the ring screws evenly and securely.

FOCUSING THE RETICLE

Secure the scope and firearm in a firm rest. Safely point the scope at a light colored background object. With the scope approximately four inches from your eye the reticle should appear sharp and crisp; if it does not, it is necessary to adjust the focus by means of the eyepiece.

If your Leupold scope is a model with an eyepiece that has a diopter lock ring, follow steps 1-4. If the scope is a model with a non-locking fast focus eyepiece, follow steps 2 & 3.

1. Grasp the thin knurled lock ring near the rear of the eyepiece and back it away from the eyepiece, toward the front of the scope.
2. If you tend to hold things away from yourself to see them clearly (you are farsighted) turn the rear-most portion of the eyepiece counter-clockwise a couple of turns. If you hold things close to yourself to see them clearly (you are nearsighted) turn the rear-most portion of the eyepiece clockwise a couple of turns.

3. Looking through the scope when pointed at the light colored background object, take a few quick glances at the reticle. The focus of the reticle should be noticeably different than when you started. Continue this process until the reticle appears clear and sharp.
4. When you are satisfied with the image of the reticle, turn the lock ring clockwise so that it rests firmly against the eyepiece.

WARNING

If a scope is mounted too far to the rear, the eyepiece can injure the shooter's brow. Shooting at an uphill angle also increases this hazard because it shortens the distance between the brow and the rear of the scope. For this reason, Leupold scopes are engineered to provide generous eye relief. Therefore, when mounting your scope, we recommend positioning it as far forward in the mounts as possible to take full advantage of this generous eye relief.

HOW TO SIGHT-IN

USING A BORE-SIGHTING COLLIMATOR

To save time and ammunition, start out in your shop or gun room with a bore-sighting collimator. Follow the directions included with the collimator for specific instructions on its proper use. Remember, when possible, it is better to make the initial windage adjustments to the mount base before using the scope's windage adjustment.

NOTE: Bore-sighting alone is not sufficient to sight-in a scope. You must make final adjustments by shooting the firearm using the same ammunition you use in the field.

TRADITIONAL BORE-SIGHTING (BOLT ACTIONS)

Preliminary sighting-in can also be accomplished by bore-sighting at the firing range using a target from 20 to 50 yards away.

1. Position the firearm on the bench, using sandbags to steady the firearm.
2. Remove the bolt from the firearm.

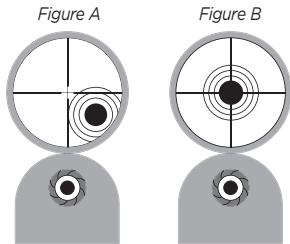

Target is centered in bore

3. Looking through the bore itself, move the firearm to center the bull's-eye of the target inside the barrel. (FIGURE A)
4. Hold the rifle steady. With the bull's-eye centered when viewed through the bore, make windage and elevation adjustments to the scope until the very center of the reticle is aligned with the bull's-eye of the target. (FIGURE B)

TRADITIONAL BORESIGHTING OF AR-15 AND M-16 FIREARMS USING A TARGET

from 20 to 50 yards away:

1. Position the firearm on the bench, using sandbags to steady the firearm as necessary.
2. Release the rear receiver pin of the firearm.
3. Separate the upper and lower receiver halves.
4. Remove the bolt.
5. Position the firearm with the muzzle facing the target.
6. Looking through the bore itself, move the firearm to center the bull's-eye of the target inside the barrel.
7. Hold the rifle steady. With the bull's-eye centered when viewed through the bore, make windage and elevation adjustments to the scope until the very center of the reticle is aligned with the bull's-eye of the target (see figures A and B on page 7).

THE FINAL STEP: THREE-SHOT GROUPS

Whichever bore-sighting method you've used, the next steps are the same on the firing range. To ensure reliable results, always fire from a rested position when performing these steps.

1. Fire a shot or two.
2. If you are several inches off center, make an appropriate amount of adjustment to move the reticle to the center of the target.
3. Carefully fire a three-shot group.
4. Use the center of that group as a reference point for the final adjustments to windage and elevation. To learn about making final adjustments, review the section on Making Precise Windage and Elevation Adjustments.

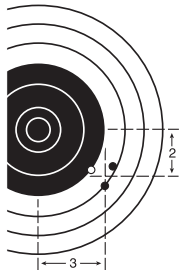

MAKING PRECISE ELEVATION AND WINDAGE ADJUSTMENTS

The style of elevation and windage adjustments on Leupold tactical riflescopes varies with specific models. Each, however, is clearly marked in easy to read increments. If, for example, there

are four hash marks from zero to (and including) the number one on an adjustment dial, then the value of each increment of adjustment on that dial is 1/4-MOA.

Another example is, if there are 10 hash marks from zero to (and including) the number one, then the value of each adjustment increment is 0.1 milliradian.

The letters found on the windage and elevation dials refer to the direction that the point-of-impact of the bullet is moved when an adjustment is made.

Certain models of Leupold Tactical riflescopes are equipped with locking windage and elevation adjustment dials to prevent accidental movement while in the field. It is important to make sure the adjustment dials are completely unlocked prior to making adjustments in order to avoid damage to the riflescope.

If your Leupold Tactical riflescope is a model with M5A2 Auto-locking Pushbutton adjustments, you must depress the button in the center of the adjustment dial to release the lock while turning the dial to make the adjustment. The adjustment dial will automatically lock into place at any point within the dial travel when the button is released.

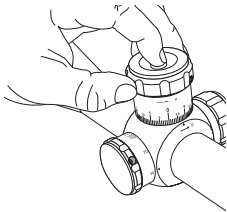

If your Leupold Tactical riflescope is a model with M5B1 or M5B2 Auto-locking Pinch and Turn adjustments, you must pinch the lock release ring around the dial to release the lock, while turning the dial to make the adjustment. The adjustment dial will automatically lock into place at any point within the dial travel when the lock ring is released.

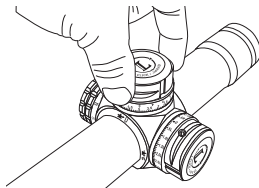

If your Leupold Tactical riflescope is a model with M5C2, M5C3 or M6C1 ZeroLock™ adjustment dials, you must push inward on the lock release button located on the outer edge of the dial above the zero indicator mark to make an adjustment. Once the dial has been turned one or more clicks past the zero position it is no longer necessary to press the lock release button. The ZeroLock adjustment dials will only lock when at the zero position of the dial travel.

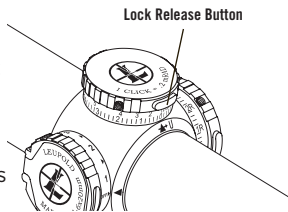

Many of the adjustments on Leupold Tactical riflescopes are equipped with a rotational stop, zero stop, or hard stop at both ends of the dial travel.

Some Leupold Tactical riflescope adjustments also include a revolution indicator to keep track of dial position

through more than one complete revolution. Please see pages 15-16 for information on re-setting the dial revolution indicator.

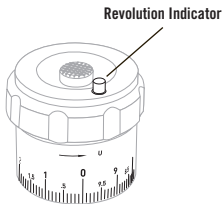

WINDAGE ADJUSTMENTS

CAUTION:

Failure to disengage the windage adjustment lock (if applicable) prior to rotating the windage adjustment can damage the adjustment mechanism.

Windage adjustments can be made by removing the adjustment cover (if applicable) on the right side of the scope and rotating the windage adjustment dial. To move the point of impact to the left, rotate the adjustment clockwise. Each click of the windage dial will move the point of impact the distance of one increment as indicated on the dial (1/4-MOA, 1/2-MOA, 0.1 Mil, 0.2 Mil). If your windage dial has a rotational stop, see "Bypassing Windage Dial-Stop" on page 13.

BYPASSING THE WINDAGE DIAL-STOP

Some windage adjustments have a rotational stop to prevent the dial from turning more than one revolution in the field. To prevent this from hindering sight in, the rotational stop can be bypassed by loosening the three set screws around the dial, pulling the dial over the hard stop and retightening the set screws. To reset the windage dial to one revolution once sighted in, loosen the set screws and align the zero to the indicator mark on the scope housing, then retighten the set screws.

NOTE: Some models of Leupold Tactical riflescopes have a slotted adjustment screw under the windage and elevation adjustment dials. If your scope is a model with a slotted adjustment screw, you may remove the dial and make adjustments using a coin or flat blade driver during sight in. Once sighted in, reinstall and align the dial with the zero indicator, then tighten the set screws.

ELEVATION ADJUSTMENTS

CAUTION:

Failure to disengage the elevation adjustment lock (if applicable) prior to rotating the elevation adjustment can damage the adjustment mechanism.

Elevation adjustments can be made by removing the adjustment cover (if applicable) on the top of the scope and turning the dial. To move the point of impact up, rotate the elevation adjustment counter-clockwise. To move the point of impact down, rotate the elevation adjustment clockwise. Each click of the elevation dial will move the point of impact the distance of one increment as indicated on the dial (1/4-MOA, 1/2-MOA, 1.0-MOA, 0.1 Mil, 0.2 Mil).

BYPASSING THE ELEVATION DIAL-STOP

Some elevation adjustments have a rotational stop to prevent the dial from turning more than one or two revolutions in the field. To prevent this from hindering sight in, the rotational stop can be bypassed by loosening the three set screws around the dial, pulling the dial over the hard stop and retightening the set screws.

ZEROING THE WINDAGE AND ELEVATION DIALS

Leupold riflescopes feature adjustment dials that can be repositioned to align the marked zero of the dial with the position indicator without changing the adjustment setting of the riflescope.

This allows the shooter to know the original zero of the rifle in the event that further adjustments are made in the field. To reposition the dials on tactical riflescopes, loosen the set screws surrounding the dial, slip the dial until the zero aligns with the witness mark on the maintube, then tighten the set screws utilizing the provided hex key.

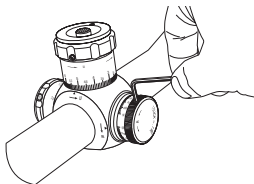

Zeroing the windage dial

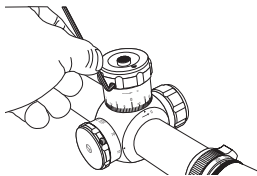

Zeroing the elevation dial

ELEVATION DIAL REVOLUTION INDICATOR

Some Leupold Tactical riflescopes are equipped with elevation dials featuring a visual and tactile revolution counter, indicating that the second revolution of adjustment has been initiated.

M5A2 Auto-locking Pushbutton

To reset the revolution counter on the M5A2 Auto-locking Pushbutton elevation adjustment, loosen the set screws on the elevation dial and remove the dial from the adjustment. Tighten the Elevation Collet by rotating it clockwise until it is secured firmly against the adjustment turret housing. Reinstall the dial making sure the dial is turned clockwise back to zero and the revolution indicator is at its lowest position (slightly below flush with the top of the dial). Retighten the set screws.

M5B2 Auto-locking Pinch and Turn and M5C2 ZeroLock

To reset the dial without adjusting the point of impact, loosen the set screw. Hold the adjustment down while turning the dial clockwise until the rotation counter is down and the dial will rotate no further. This resets the rotation counter to the zero stop position. Retighten the set screw. Once the rotation counter and dial have been rezeroed, the M5B2 indicator dial can be adjusted. The indicator dial has numbers engraved along the portion of the elevation dial representing the adjustment increments in mils. Press the two pins of the M5B2 in while lifting the indicator ring up, to align the indicator ring's zero to the witness mark on the maintube and press the ring back down to lock in place.

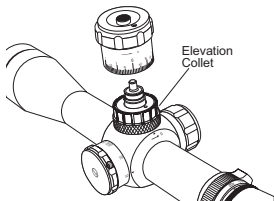

Setting the elevation revolution counter

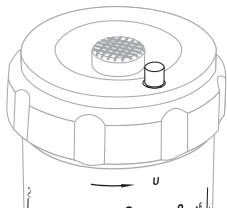

Elevation dial revolution counter

M5B2 AUTO-LOCKING PINCH AND TURN ADJUSTMENTS

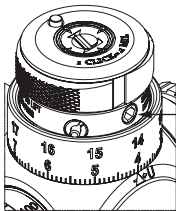

Loosen set screw.

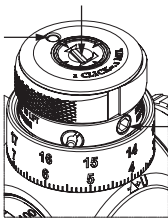

Press dial down while turning clockwise until stop is engaged.
Rev. indicator will retract.
Tighten set screw.

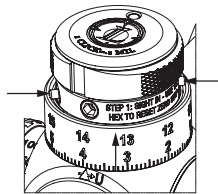

Depress two spring loaded pins while pulling up ring.

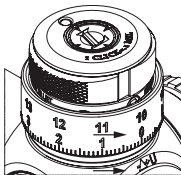

Rotate ring and align to Zero.

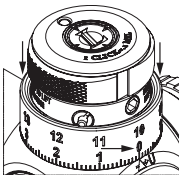

Push down ring to lock in place.
Verify "Zero" alignment.

BULLET DROP COMPENSATION DIALS (BDC)

Special bullet drop compensation (BDC) elevation dials are featured on selected scopes. These dials are calibrated to achieve adjustment to specific distances rapidly by distance indicators marked directly on the dials. We recommend that you zero your scope at the shortest distance for which you have a reference mark on the dial; in most cases, 100yd/m. During the sight-in process, ignore the distance indicators on the elevation adjustment and follow the standard zeroing procedure.

SETTING THE BDC ELEVATION DIAL

After you have achieved a good zero, loosen the three set screws located on the knurled rim of the dial; you will notice that the dial can now rotate freely, without clicking or making internal adjustments. Rotate the dial until the appropriate range reference number lines up with the reference mark on the back of the adjustment housing. For example if you zeroed the rifle at 100 yards, rotate the dial to the 100 yard mark and tighten the set screws. Your BDC dial is now ready to use.

USING THE BDC DIAL

Once you have sighted-in and set the BDC dial, simply turn the dial to the appropriate distance and hold precisely where you want the bullet to impact; the BDC accounts for all elevation compensation. For a 400 yard shot, rotate the dial in the "up" direction until the "4" is aligned with the reference mark on the

back of the adjustment housing and hold directly on the target. The same is true for distances falling between yardage marks; if you have a 350 yard shot, simply set the dial directly between the "3" and the "4".

LONG RANGE PRECISION

When consistently shooting long distances, some people prefer to sight-in at a mid-range distance to minimize the effects of variances in actual component performance. For example, your ammunition may produce a slightly different muzzle velocity when fired from your rifle. By sighting in at a mid-range distance such as 300 yards, the effects of a different muzzle velocity will be split between your short range and long range shots, with your mid-range shots being exact.

To accomplish this, simply zero at 300 yards and set the dial to the 300 yard reference mark. Any minor variances will be divided between your shorter and longer distance marks, essentially reducing any potential error by 50%.

REPLACEMENT BDC COMPONENTS

Occasionally the set screws and/or included wrench become worn or lost and require replacement. If you require a replacement screw or wrench, please contact Leupold Technical Services at 1-800-Leupold (1-800-538-7653) and we will be happy to send replacements.

CENTERING WINDAGE AND ELEVATION ADJUSTMENTS TO ACHIEVE OPTIMUM ADJUSTMENT TRAVEL

Making windage and elevation adjustments moves the entire erector system horizontally and vertically inside the scope.

Leupold Tactical riflescopes are shipped from the factory with the adjustments centered optically in the system, however if the erector system is off to one side - as a result of having previously been mounted on a non-adjustable mount - the adjustments won't provide equal travel in all directions. To regain full balanced travel, you must recenter the adjustments as follows:

1. Turn the windage adjustment to the point that it stops moving.
2. Counting the clicks or hash marks, turn it all the way in the other direction.
3. Turn the dial back half the amount of clicks or hash marks counted.
4. Repeat this process for the elevation adjustment.

WHAT YOU SHOULD KNOW ABOUT VARIABLE POWER SCOPES

Leupold variable power scopes allow you to select from a range of magnifications to suit your particular rifle, cartridge, and shooting needs.

WARNING: Do not loosen the screw in the power selector ring; doing so will release the internal gas that keeps the scope fog free. Loosening the screw will also disconnect a pin that controls the internal operations, causing other problems that would require factory repairs. Do not lubricate the power selector ring; doing so is unnecessary

ABOUT FIXED PARALLAX DISTANCE SCOPES

Any fixed focus optical system can be adjusted to be parallax free at only one distance. Most Leupold scopes are parallax free at 150 yards.

SETTING PARALLAX

1. The reticle should be clear (focused) before adjusting the parallax. If it is not follow the under "Focusing the Reticle".

2. With the firearm in a stable position, look through the scope, concentrating in the center aim point of the reticle.
3. Move your head slightly up and down while turning the side parallax dial or adjustable objective ring until the reticle does not move in relation to the target.

INSTALLING A LENS ATTACHMENT

Many Leupold scopes offer threaded objective and eyepiece rings to allow for the attachment of lens covers and a variety of Alumina® accessories. These attachments thread directly into the objective or eyepiece rings. Turn until finger tight – do not over tighten.

USING THE ILLUMINATION

Select Leupold Tactical riflescopes may be used in either the standard or the illuminated state. When not illuminated, the reticle performs the same as the reticle in a standard non-illuminated Leupold scope. When the illumination is activated, portions of the reticle will illuminate to provide better contrast in poorly lighted conditions between the target and the precise position of the aiming point.

DIAL ILLUMINATION

To illuminate the reticle:

1. Grasp the illumination dial located on the eyepiece, maintube or adjustment turret (depending on model).
2. Turn the dial clockwise from the OFF position to the first number indicated on the dial.
3. View the target through the scope to determine if the reticle is bright enough to stand out clearly against the target.
4. If more illumination is required, continue turning the dial clockwise until the reticle is clearly visible against the target. The first 2 settings are night vision compatible, while settings 3-7 are intended for use in brighter situations.
5. For convenience, there is an OFF position located between each of the intensity settings, allowing you to preserve the battery and quickly obtain your preferred illumination setting.

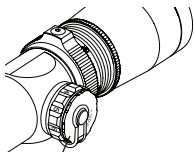

Mark 8 illumination control dial

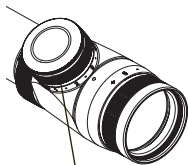

Eyeshell illumination control dial

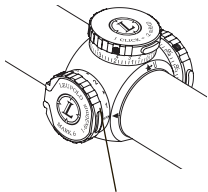

ZeroLock illumination control dial

PUSHBUTTON ILLUMINATION

To illuminate the reticle:

1. Press and release the button on the left side of the adjustment turret.
2. To adjust the intensity of the aiming dot, press and release the button repeatedly. The aiming dot will flash 5 times when the brightest setting is reached, then begin decreasing each time the button is subsequently depressed. When the lowest setting is reached, the aiming dot will flash 5 times and begin increasing each time the button is subsequently depressed.
3. View the target through the scope to determine if the aiming dot is bright enough to stand out clearly against the target.
4. If more illumination is required, continue pressing and releasing the button until the aiming dot is clearly visible against the target. The lower settings are designed to be used in low light, while the brighter settings are intended for use in brighter situations.
5. To deactivate the illumination, press and hold the button for at least 3 seconds. When reactivated, the illumination will return to the last used setting.

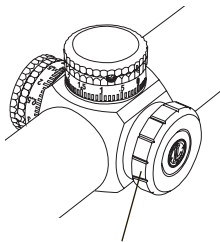

Pushbutton illumination control dial

Note - Advanced Use: To change the direction of adjustment, ie change from increasing intensity to decreasing intensity, press and hold the button for 2 seconds and immediately release the button. Then continue pressing and releasing to change intensity.

CHANGING THE BATTERY

The battery for the illuminated reticle is located inside the illumination control dial and can be changed without tools. If the reticle fails to illuminate or appears dim even on the highest illumination setting, it is necessary to change the battery. Leupold tactical scopes use a CR2032 lithium coin-cell battery.

To change the battery:

1. Remove the battery cover by twisting the cover counterclockwise while holding the sides of the illumination dial to keep the entire dial from turning (It is not necessary to hold the sides of the Pushbutton control. To open the Mark 6 battery cover press the recessed latch and the cover will pop open).
2. Remove the old battery from its position in the center of the dial. This can be done in two ways:

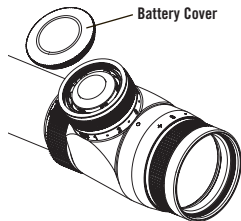

(A) Grasp the edges of the battery between the thumb and forefinger and lift it free of the dial.

OR

(B) Turn the scope so that the illumination dial faces downward and gently tap the illumination control against the edge of your palm.

3. Insert the new battery, positive (+) side up.
4. Replace the battery cover on the illumination dial and turn it clockwise until it is secure, while holding the sides of the illumination dial to keep the entire dial from turning.

REPLACEMENT 3-VOLT LITHIUM BATTERIES

CR2032 batteries are becoming as common and are as readily available as typical battery sizes (AAA, AA, C, and D). Replacement CR2032 lithium coin batteries can be purchased at most stores where batteries are sold. Use only high quality battery brands such as Sony®, Energizer®, Panasonic®, or Duracell® for safe and efficient battery performance.

LEUPOLD MEANS MINIMAL MAINTENANCE

LENSES

Leupold scope lenses are coated to reduce light reflections and light scattering, thus increasing light transmission through the scope. They should be cleaned as carefully as you would a camera lens. Begin by using a lens brush to remove dust and then pure alcohol, high-grade glass cleaner, or pure water on a cotton swab.

WINDAGE / ELEVATION ADJUSTMENTS

These adjustments are permanently lubricated. There is no need to lubricate them.

EYEPIECE

The eyepiece is permanently lubricated. There is no need to lubricate it. The eyepiece can be rotated as far as it will go in either direction, it will not detach from the scope as there is an internal lock ring.

SEALS

Leupold scopes are sealed from within by several methods, including O-rings. All seals are permanent and require no maintenance.

SCOPE EXTERIOR

Leupold scopes are made of rugged 6061-T6 aircraft aluminum alloy. No maintenance of any kind is required; simply wipe off any dirt or fingerprints that accumulate with a clean, dry cloth.

POWER SELECTOR

No lubrication is ever required on the power selector ring.

TROUBLESHOOTING TIPS

Before you ship a scope back to the factory for service or repair, please check the following items:

1. Check the mount to make sure the scope is mounted securely to the rifle. Try, with bare hands only, to gently twist the scope in the rings or see if anything moves when you jiggle it. If there is any movement, retighten the mounting system according to mounting instructions.
2. Make sure the action of your rifle is properly bedded in the stock, and that all receiver screws are tight and have been tightened in the sequence recommended by the manufacturer. A loosely fitted stock can cause changes to the point-of-impact.
3. When test firing a rifle to check the point-of-impact relative to windage and elevation adjustments, be sure to fire from a solid bench with sandbags supporting the forearm and buttstock.

4. Be sure to use factory-loaded ammunition of the same bullet type, weight, and preferably, lot number. If one type of ammunition does not shoot well, try another brand or bullet weight.
5. Be certain that both the barrel and chamber are clean. Heavy factory grease or copper fouling can diminish accuracy.

LEUPOLD PRODUCT SERVICE

If your Leupold scope fails to perform in any way, you may return it directly to the factory for service. We recommend contacting Leupold Technical Service at 1-800-Leupold (538-7653), and following these shipping instructions:

Register your product at Leupold.com/register

1. Remove the rings and any other accessories from the scope.
2. Record the serial number of the scope and keep it for your records.
3. Include a note with your name, address, telephone number, E-mail, and a description of the problem.
4. Pack the scope in its original box (if you have it), as this is the safest shipping container. Wrap the package securely using filament strapping tape on the outside.
5. Ship the scope by parcel or mail service (insured, if possible) to one of the following addresses:

IN THE UNITED STATES:

Parcel Service:

Leupold Product Service

14400 NW Greenbrier Parkway

Beaverton, OR 97006-5790 U.S.A.

By Mail:

Leupold Product Service

P.O. Box 688

Beaverton, OR 97075-0688 U.S.A.

OUTSIDE THE UNITED STATES:

Canada: Korth Group Ltd., 64186-393 Loop East, Okotoks, AB T1S 0L1, Canada

Australia: Nioa, PO Box 191, Pinkenba, Qld 4008 Australia (for items originating from Australia, New Zealand, New Caledonia and Japan)

South Africa: Formalito, 1019 Pretorius Avenue, Lyttleton, 0157, South Africa

Our Product Service telephone numbers are (503) 526-1400 or (800) LEUPOLD (538-7653), fax is (503) 352-7621. They can also be contacted through our Web site at leupold.com.

Some Leupold tactical scopes must be serviced by our factory in the United States. A U.S. Department of State License is required for the export & import of ALL products under the International Traffic in Arms (ITAR) Regulations (22CFR, Parts 120-130); we strongly recommend contacting us directly prior to sending any tactical riflescope from outside the United States.

A Department of Commerce Export License may be required to certain countries under the Bureau of Industry and Security Export Administration Regulations, EAR (15CFR, Parts 730-774). Diversion contrary to U.S. law is prohibited.

LEUPOLD LIFETIME GUARANTEE

Anyone can offer you a lifetime warranty, but guaranteeing performance takes serious dedication and craftsmanship. From our Beaverton Oregon factory, to the wilderness, the battlefield, and everywhere in-between, we won't let you down.

If your Leupold scope, sight, binocular or spotting scope doesn't perform, we will repair or replace it for free, whether you're the original owner or not - forever.

For complete details visit leupold.com/warranty

LEUPOLD MAKES MORE THAN SCOPES

See our complete line of rangefinders, mounting systems, binoculars, spotting scopes, thermal optics and accessories at your nearest Leupold dealer.

For a free Leupold catalog, write to:

Leupold & Stevens, Inc., P.O. Box 688, Beaverton, OR 97075,
call (503) 526-1400 or (800) LEUPOLD (538-7653),
or send us an E-mail through our Web site at leupold.com.

LEUPOLD, GOLD RING, MARK 4, the Golden Ring design, the circle-L reticle logo design, and various other marks are registered trademarks of Leupold & Stevens, Inc. All marks, including corporate logos and emblems, are subject to Leupold's rights and may not be used in connection with any product or service that is not Leupold's, or in any manner that disparages or discredits Leupold, or in a manner likely to cause confusion.

Certain other trademarks used in connection with Leupold products and services are the property of their respective owners, and are used with permission. THE BOONE & CROCKETT CLUB® and BOONE & CROCKETT® are registered trademarks of the Boone & Crockett Club. RMEF® and ROCKY MOUNTAIN ELK FOUNDATION® are registered trademarks of the Rocky Mountain Elk Foundation. Mossy Oak® Break-Up®, Mossy Oak® Break-Up® Country®, Mossy Oak® Break-Up® Infinity™, Mossy Oak® Mountain, Mossy Oak® Obsession®, and Mossy Oak® Treestand®, are trademarks or registered trademarks of HAAS Outdoors, Inc. A.R.M.S. ® is a registered trademark of Atlantic Research Marketing Systems, Inc. The ARD (anti-reflection device) is manufactured by Tenebraex a Division of Armament Technology Incorporated 110 Chain Lake Drive Unit 3E, Halifax NS Canada B3S 1A9

Cordura® is a registered trademark of INVista North America S.A.R.L. Freedom Arms® is a registered trademark of Freedom Arms, Inc. Horus® and Horus Vision® are registered trademarks of Horus Vision, LLC. Kryptek®, Kryptek® Highlander®, and Kryptek® Typhon™ are trademarks or registered trademarks of Kryptek Outdoor Group, LLC. Magnum Research® is a registered trademark of Magnum Research, Inc. Ruger® is a registered trademark of Sturm, Ruger & Company, Inc. Torx® is a registered trademark of Acument Intellectual Properties, LLC. ZEMAX® is a registered trademark of Zemax, LLC. Zygo® is a registered trademark of Zygo Corporation.

For patent information, visit leupold.com/patents

We reserve the right to make design and/or material modifications without prior notice.

Copyright © 2018 Leupold & Stevens, Inc. All rights reserved.



LEUPOLD[®]

leupold.com

LEUPOLD & STEVENS Inc.

P.O. Box 688

Beaverton, OR 97075-0688 U.S.A.

1 (800) LEUPOLD (538-7653)

14400 NW Greenbrier Parkway

Beaverton, OR 97006-5790 U.S.A.

(503) 526-1400

Part# 111426 Artwork# 111428G