

EOTECH®

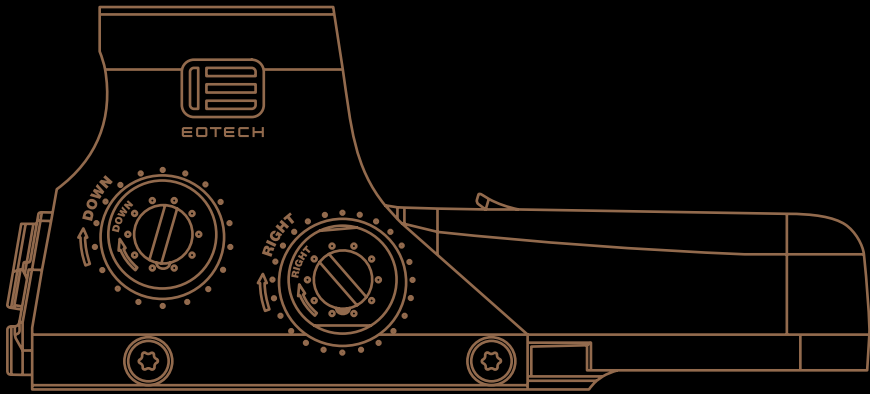

---

---

**552™**

HWS® (HOLOGRAPHIC WEAPON SIGHT)



---

# Contents

---

## 1 / SHOW SOME RESPECT

Distribution Statement . . . . .	4
Warnings . . . . .	4
Caution . . . . .	5

## 2 / THE BASICS

General Info . . . . .	6
Key Attributes . . . . .	6
Reticles . . . . .	8
Specifications . . . . .	9
Anatomy . . . . .	10
Definitions . . . . .	11

## 3 / GET STARTED

Operating Instructions . . . . .	12
Mounting the HWS . . . . .	13
Battery . . . . .	14
Battery Recommendations	
Replacing the Battery	
Electronic Features . . . . .	16
Night Vision Mode . . . . .	17
Windage and Elevation . . . . .	18
Zeroing Procedures . . . . .	19

## 4 / MAINTENANCE

Cleaning Instructions . . . . .	20
Operator Level Maintenance . . . . .	21
Troubleshooting . . . . .	22

## 5 / NEED SOME HELP?

Service and Repair . . . . .	24
Replacement Items . . . . .	24
Contact Information . . . . .	25

## Distribution Statement

Approved for public release; distribution is unlimited.

This commodity is controlled under the Export Administration Regulations (EAR), ECCN 0A504.b, and may not be exported to a Foreign Person, either U.S. or abroad, without a license or exception from the U.S. Department of Commerce.

## Warnings

### Weapon Safety

Prior to mounting the HWS on your weapon, be sure the weapon is cleared. If you are not sure how to clear your weapon, please see the operator's manual that accompanied the weapon platform you are mounting the sight on.

### Laser Safety







The HWS is a Class I laser product. The illuminating beam can become accessible to the eye if the housing is broken. Turn the sight off immediately and return the broken unit to the factory for repair.



### FCC Compliance

The HWS complies with Part 15 of the FCC Rules. Operation is subject to the following conditions: (1) this device may not cause harmful interference and (2) this device must accept any interference received, including interference that may cause undesired operation. Complies with 21 CFR Chapter 1, Subchapter J.

## Caution

-  **Never disassemble the sight's optical assembly.** The optical cavity is purged, nitrogen filled, and sealed to achieve fog-resistant performance. Disassembly will void the warranty and render the sight inoperable.
-  **Ensure the HWS is off before using night vision mode.** Once the sight is OFF, pressing the NV button activates the NV mode for use with an HWS in tandem with a night vision device. Brightness settings in NV mode are only detectable when using night vision.
-  When a sudden increase in resistance is felt in the elevation or windage adjustment shafts, the end of the adjustment range has been reached. **DO NOT TURN THE ADJUSTMENTS ANY FARTHER OR SERIOUS DAMAGE MAY OCCUR TO THE SIGHT.**
-  **Always dampen the glass surfaces prior to cleaning.** Never clean the glass surface with a dry cloth or paper towel.
-  All moving parts of the sight are permanently lubricated. **Do not try to lubricate them.**
-  **Do not use deteriorated or corroded batteries.** Inspect batteries for rips, tears, dents, or cuts in the battery housing. If there is any exposed internal content of the battery, it could affect the operation of the sight.
-  The 552 HWS units are designed to mount directly to either a 1" (25.4mm) Weaver or MIL-STD-1913 rail specification.

### General Info

This manual is an overview of the 552 HWS (Holographic Weapon Sight), and will define the basic operation, features/benefits, and options of this proprietary optical system. The HWS is a state-of-the-art optical sighting system, employing holographic sighting technology for small to medium caliber weaponry and launching type platforms. The HWS utilizes holographic optics fabrication technology that is used in the production of advanced heads up display in attack fighter aircraft for targeting, gauge reading, weapon system verification, etc. EOTECH® has miniaturized the sophisticated sighting heads up display system into a compact and rugged package for use on small arms and other weapon platforms.

### Key Attributes

The 552 HWS is a lightweight, non-magnifying, optical sight designed for close to midrange engagements. It allows very fast target acquisition and engagement at short ranges while providing aiming capability out to 300 meters equal to or better than iron sights.

The major combat advantage of the HWS is extremely rapid reticle-on-target acquisition. As quickly as a target is identified, the holographic reticle can be superimposed on the target. The sight allows operators to maintain eye contact on the target and to place the holographic reticle onto the target without shifting focus. Operators can quickly acquire the target and reticle in the same focal plane for fast and accurate shot placement.

The HWS appears to project the holographic image of a reticle on the target plane. The sight can be used as a bright open reticle image or a fine dot. The heads-up display window allows an undistorted and unrestricted view of the target.

The HWS offers extremely fast target acquisition in Close-Quarters Battle (CQB) using the large ring, and aiming precision in longer range engagements (using the MOA Dot) without obscuring the target.

Another advantage of the HWS is the full field of view which allows the operator better situational awareness. The HWS employs a true heads-up display (HUD) window that eliminates blind spots and constricted or tunnel vision associated with scope sights. Controls are inset into the HWS housing with no protruding knobs, battery compartments, or rings obscuring the target. Utilizing natural binocular vision is an advantage of this sighting system, as well as additional threat identification through increased operator situational awareness and peripheral vision.

The 552 can operate in tandem with Generation I – III+ night vision intensifier tubes. Operators can see the holographic reticle image with helmet mounted or weapon mounted night vision devices. The HWS is a passive system and emits no signature from frontal or from a peripheral aspect. While in the NV mode, the sight is undetectable by opposing force night vision equipment. The HWS can be positioned behind night vision systems without any “bloom” on the target area.

The primary use of the HWS is for the M4A1 carbine and CQBR in Close-Quarters Battle. The HWS is not however, limited to carbines. The HWS can also be used on medium caliber machine guns, grenade launchers, bolt guns, crossbows, MSR and similar platforms, and less than lethal projectile launchers. The sight provides a 1X (no magnification) sight picture and is not designed as a long range sight system; however, it can be used as effectively as iron sights on targets to 300 meters.

The advantage of the HWS is that it provides the operator superior shooting performance, rapid reticle-on-target acquisition, full field of view and accurate shot placement. The HWS can be naturally deployed by all levels of users, from novice to the most highly trained operator.

## Reticles

### HWS RETICLE ADVANTAGE

EOTECH's Holographic technology provides a distinct advantage over typical red dots. EOTECH can offer any type of reticle pattern, as opposed to being limited to a single dot. EOTECH reticle designs are fabricated so that they can incorporate multiple trajectory points of aim, range assist features, and anti-torque or cant visual indicators.

### HWS RETICLE PATTERNS

EOTECH's reticle patterns greatly impact accuracy and fast target acquisition. EOTECH's reticle patterns feature a 68 MOA ring surrounding a 1 MOA center dot, allowing the shooter to quickly pick up a target; HWS allows for more complex reticle designs with minimal parallax error.

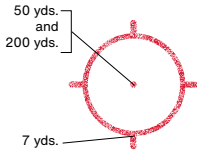

### 0 RETICLE

The 68 MOA ring with 1 MOA dot is ideal for fast target acquisition. It provides three usable aiming points. The aiming points above were based on the following load: .223 Cal. 62 Gr. 2,900 Vel. Other loads and calibers can also be used, but the operator will have to establish the ranges associated with the aiming points. When using a shotgun, the 68 MOA ring can be used to represent shot patterns, but will vary based on choke and shell selection.



### XR308 RETICLE

The XR308 reticle was designed specifically for the military M240 machine gun. It was calculated with a .308 Cal. with 150 Gr. M59 FMJ at roughly 2,800 fps with a 24.8" barrel.



## Specifications

### TECHNICAL SPECS

Optics	Transmission holography
Magnification	1X
Eye Relief	Unlimited
L × W × H	5.6" × 2" × 2.5" (142.2 × 50.8 × 63.5mm)
Weight	11.5 oz (326g)
Water Resistant	33 ft (10m) depth
Sealing	Fog-resistant internal optics
Color/Finish	Black
Adjustment (Per Click)	Approx. 0.5 MOA [1/2" (12.7mm) at 100 yds. (91m)] when zeroing
Adjustment Range	Range: +/- 40 MOA travel
Mount	1" Weaver or MIL-STD 1913 rail

### DISPLAY WINDOW

Optical Surfaces	Anti-reflection coating on external surfaces
Window Dimensions	1.20" × 0.85" (30 × 23mm)
Front Window Material	Glass 1/8" (3.17mm) thick
Rear Window Material	Laminate 3/16" (4.76mm) thick
FOV 100 Yds (91m)	30 yds. (28m) at a 3" eye relief
Reticle Options	0- 68 MOA circle with quadrant ticks with 1 MOA aiming dot XR308- (4) ballistic aiming dots designed around .308 caliber round

### ELECTRICAL

Power Source	2 × 1.5 V AA batteries — Supports lithium, alkaline, or rechargeable
Battery Life	Lithium: 2,500 continuous hours at nominal setting 12 at room temp. Alkaline: 2,200 continuous hours at nominal setting 12 at room temp.
Brightness Settings	20 daylight settings 10 additional settings for Gen I through III+ night vision devices
Auto Battery Check Indicator	Flashing reticle upon start-up
Auto Shut-Down	At 8 hrs – programmable to 4 hrs

## Anatomy

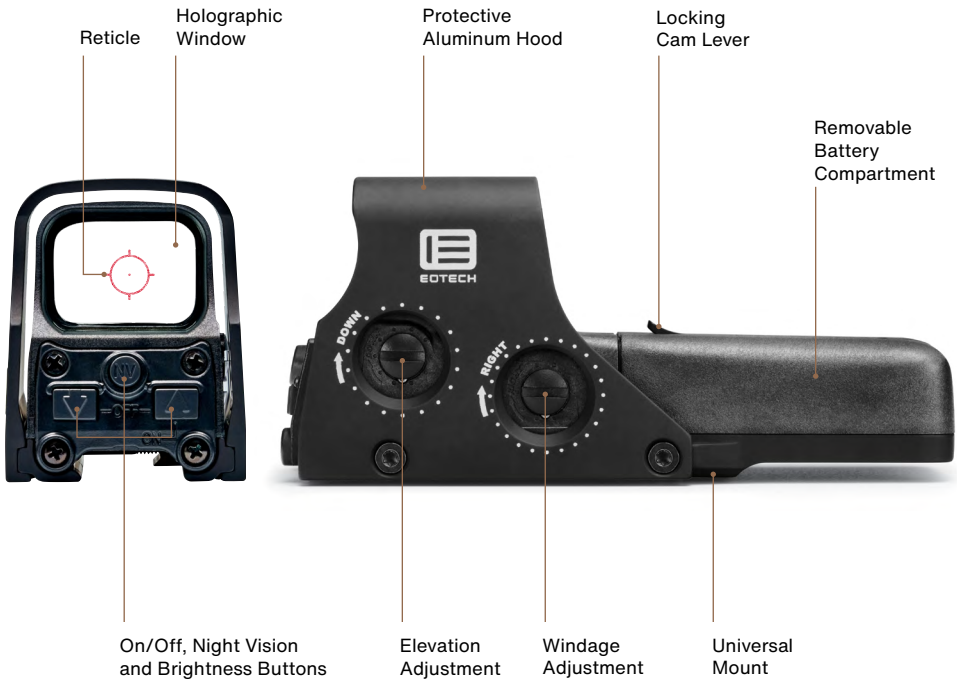

## Definitions

### **Removable Battery Compartment**

A battery cap secures and seals the battery compartment to prevent water, dirt or grime from entering the battery housing.

### **Cam Lever**

A cam lever that secures the removable battery compartment to the sight and prevents water, dirt, or grime from entering the battery housing.

### **Holographic Window**

Contains the embedded holographic reticle pattern that forms a virtual image of the reticle when illuminated by laser light.

### **ON/OFF, Night Vision and Brightness Buttons**

Raised button control interface allows the operator to perform and adjust user settings for appropriate and preferred conditions (*see page 16*).

### **Protective Aluminum Hood**

Preassembled protective hood increases durability of sight housing and protects the sight from impact damage.

### **Universal Mount**

Integrated base to accommodate all MIL-STD 1913 rail tolerances.

### **Elevation Adjustment**

Adjusts the point of aim at 100 yards approximately 1/2" per click in an upward and downward direction when zeroing.

### **Windage Adjustment**

Adjusts the point of aim at 100 yards approximately 1/2" per click in a leftward and rightward direction when zeroing.

## Operating Instructions

This section describes the features and operating instructions of the 552. Please read the instructions carefully before mounting and using the sight, and always practice proper firearm safety.

### The HWS will include:

- HWS 552 Sight
- 2 × AA Alkaline Batteries
- 7/64 Allen Key
- Quick Reference Card
- Product Registration/Warranty Card
- Hex Cross Bolt

---

**PRO TIP:** *Sight shown (below) mounted to help identify front and back.*

---

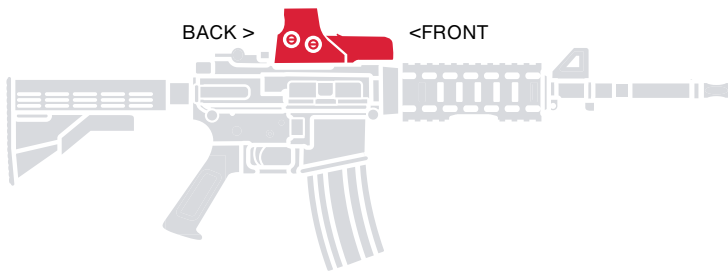

## Mounting the HWS

The 552 is equipped with mounting hardware to attach to a 1" (25.4mm) Weaver or MIL-STD-1913 Picatinny style rail (**FIGURE 1**).

To achieve the best results and accuracy, the HWS must be mounted properly. The rail needs to be as parallel as possible to the bore to permit the maximum elevation and windage adjustments.

---

**PRO TIP:** *If required, it is strongly recommend that the rail be installed by a qualified gunsmith.*

---

### To mount the sight:

1. Turn the hex bolt **counterclockwise** to back the bolt out of the weaver lock. Do not back the bolt all of the way out of the lock, only enough for the base to sit properly on the rail.
2. Turn the hex bolt **clockwise**, drawing the weaver lock into the rail until resistance is felt. Using a coin, (a U.S. nickel or similar size is recommended), rotate the bolt head an additional 1/2 turn to fully tighten. This is equivalent to approximately 17 in-lb (0.2 kgm) of torque.

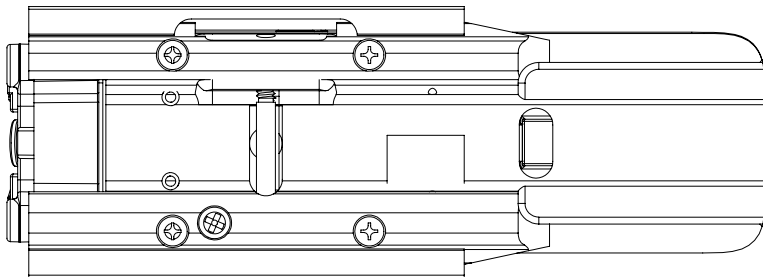

Underneath View of HWS 552

**FIGURE 1**

## Battery

- Two initially supplied (2) AA alkaline batteries power the 552 HWS.
- The HWS is designed to maintain constant brightness at a particular setting as the battery drains down. The reticle brightness will not fade as the battery runs down, but rather, shut down abruptly.
- The first indication of the battery draining is the reticle blinking when the unit is turned on (*see Electronic Features, page 16*).
- Another indication of a low battery is the reticle pattern blinking off and on during recoil. With high recoil guns, this can occur before the battery check indicates low battery condition.
- If the reticle pattern blinks off and on during recoil or turns off suddenly, replace the battery.

---

**PRO TIP:** *It is always good practice to replace the battery with a fresh ones before a mission.*

---

### Battery Recommendations

We recommend the use of Energizer™ batteries with the 552 HWS.

- **Alkaline AA batteries**

Alkaline AA batteries from different manufacturers are not all constructed the same way. Tests show some brands are more susceptible to degradation by the shock of recoil.

- **Lithium AA batteries**

Lithium AA batteries offer longer life, particularly at temperatures below freezing. For this reason Lithium batteries are recommended for cold weather operations.

- ⚠ The battery checking function, which is based on the characteristics of alkaline batteries, does not operate properly when Lithium AA batteries are used in the model 552 and may not indicate a low battery condition until very little battery life is left.

## Replacing the Battery

- Remove the battery compartment by lifting up on the locking cam lever and carefully sliding the battery compartment away and up from the sight housing (**FIGURE 2**).
- After the battery compartment is removed, slide the batteries out and replace them with a fresh set. The labels on the bottom of battery compartment show the correct battery orientation.
- Always make sure the gasket is free of dirt before the battery compartment is reinstalled or the seal may be compromised.
- To reinstall the battery compartment, point the sight towards the ground and slide battery compartment onto base.
- Make sure there is enough clearance between the contact and the batteries to avoid bending the contacts.
- Hold the battery compartment down firmly against the base and close the locking cam.
- Before you push down on cam lever, make sure the battery compartment sits all the way down and is parallel to the base.
- Verify correct battery installation immediately by turning on the sight and checking if the holographic reticle appears.
- If the batteries are left in the sight backwards, they will be drained of their power.

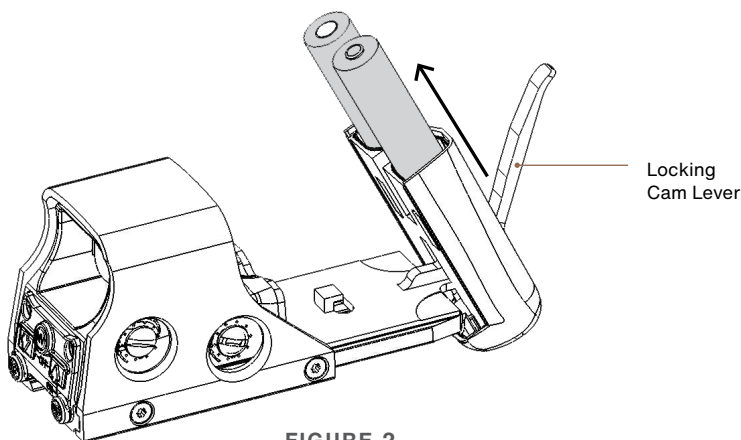
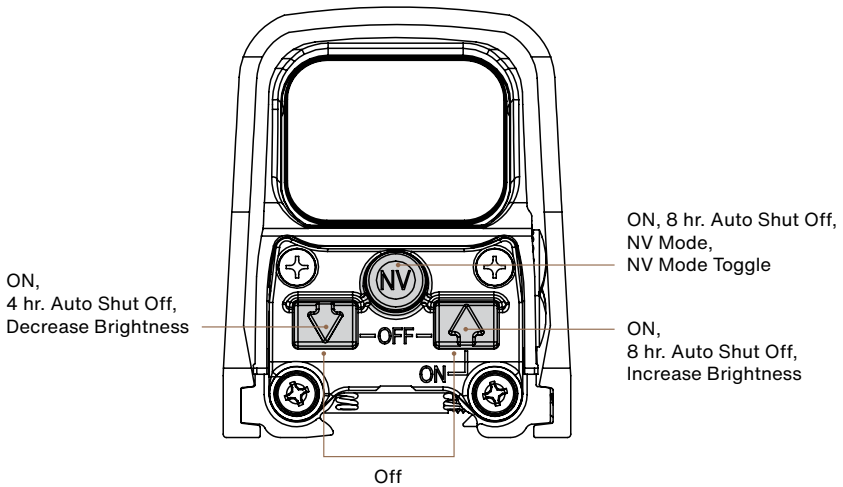

FIGURE 2

## Electronic Features

All electronic controls are via push buttons located at the rear of the unit housing (**FIGURE 3**).

**PRO TIP:** To ensure proper operation of the pushbutton switches, always press firmly on the center of the switch.



**FIGURE 3**

### ON / Auto Battery Check >

- Pressing the Up or Down Arrow buttons will turn the sight ON at Level 12.
- The sight will automatically perform a battery check every time it is turned on.
- The reticle will blink when the batteries have between 20 percent or less useful life left.

### OFF >

- To turn the sight off, simultaneously press both the UP and DOWN arrows.
- Verify that the sight is ON/OFF by looking through the window for the reticle.



**Brightness Adjustment >**

- The push buttons vary the brightness intensity of the holographic reticle pattern.
- Pressing the UP or DOWN buttons will increase or decrease the brightness level.
- There are twenty (20) daytime brightness settings provided to allow the user to adjust the reticle brightness to their preference.

**Auto Shutdown >**

- The HWS has an auto shutdown feature.
- If the sight is turned on by pressing the UP button, it will automatically shut itself OFF 8 hours after the last pushbutton control is used.
- If the sight is turned on by pressing the DOWN button, it will automatically shut OFF after 4 hours.

## Night Vision Mode

The 552 is compatible with Generation I - III+ Night Vision Devices. At the night vision settings, the reticle brightness is low enough that when viewed with a night vision device, the reticle image does not bloom.

**• ON/ Night Vision Mode and 8 Hour Auto Shut Down**

Pressing the NV Button (**FIGURE 3**) will turn the sight ON in Night Vision Mode. The sight will turn on at Level 4 and automatically shut off 8 hours after the last pushbutton control is used. There are ten (10) NV brightness settings provided to allow the user to adjust the reticle brightness to their preference.

**• OFF/ Turning Sight OFF**

To turn the sight off, press both the UP and DOWN arrows simultaneously. Verify that the sight shuts off by looking through the heads-up window with the night vision device.

**• TOGGLE/ Between Normal and Night Vision Modes**

To toggle between NORMAL and NIGHT VISION MODES, press the NV button. When switching between modes, the sight will remember the last brightness setting.

---

**NOTE:** When used with a Night Vision device, always check to make sure the sight is not turned on before pressing the NV button to turn on the sight in the Night Vision mode. Otherwise, it will toggle to the Normal mode and saturates the image intensifier.

---

## Windage and Elevation

The HWS features subtle click mechanisms for elevation and windage adjustments (**FIGURE 4**).

**PRO TIP:** These adjustment mechanisms are grooved with a slotted screw head and require the use of a screwdriver, coin, or spent brass to turn.

### Adjustment Details

- For both elevation and windage, each click will change the sight's point of aim approximately 1/2 Minute of Angle (MOA), 1/4" (6.35mm) at 50 yards (45.7m), or 1/2" (12.7mm) at 100 yards (91m) when zeroing.
- Also, one full rotation of either knob will change the point of aim approximately 10 MOA, 5" (127mm) at 50 yards (45.7m), or 10" (254mm) at 100 yards (91m) when zeroing.
- To move the point of impact UP, turn the elevation adjustment LEFT.
- To move the point of impact RIGHT, turn the windage adjustment RIGHT.

The HWS elevation and windage adjustments are factory collimated with the bore of the rifle parallel to the mounting rail. The sight should be close to mechanical zero when mounted on a properly installed rail. Be sure to check that the mount and sight are securely mounted after initial firing.

**⚠ CAUTION:** When encountering an increase in resistance in adjustments, the end of the adjustment range has been reached. **DO NOT** turn the adjustments any farther as serious damage may occur to the sight.

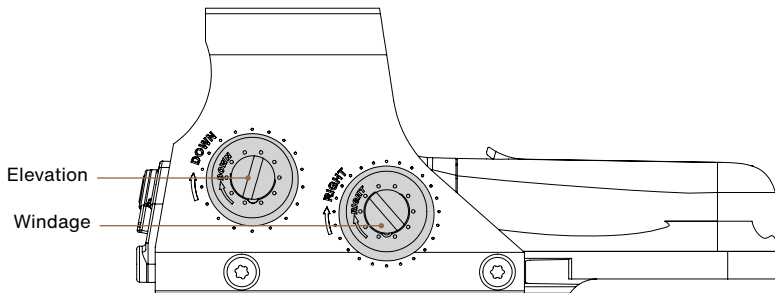

FIGURE 4

## Zeroing Procedures

Please refer to the Windage and Elevation Adjustment to zero the HWS. The following are some additional reference aids that can be used during the zeroing process.

### Bore Sighting

Bore sighting the HWS saves time and ammunition at the range. This can be done using a laser bore sighter per the manufacturer's instructions or by removing the bolt on a bolt action rifle and visually sighting through the barrel.

#### To visually bore sight your HWS:

- Verify that the rifle is clear and unloaded, then remove the rifle's bolt and place the rifle on a stable platform.
- Look through the barrel at a target approximately 100 yards away.
- With the target in the center of the barrel, make elevation and windage adjustments until the dot of the HWS is also centered on the target.
- The HWS is now bore-sighted. Move on to range sight-in to fine tune your zero.

#### Live Fire Range Sight-In:

- Using the same ammunition that you plan to shoot or hunt with, fire a 3-shot group at your preferred zero distance.
- Keeping the gun barrel steady on your aiming target, adjust your windage and elevation so that the reticle aligns with the approximate center of the 3-shot group.
- Fire another 3-shot group to see if it now groups on the center of the bullseye.
- Repeat this process as necessary to achieve an accurate zero.

---

**PRO TIP:** *When making adjustments on your sight, a coin is a good tool to use because the soft alloy won't scratch your windage and elevation adjustments.*

---

## Cleaning Instructions

- ⚠ CAUTION: NEVER DISASSEMBLE THE SIGHT'S OPTICAL ASSEMBLY!**  
**Disassembly will void the warranty and damage the sight.**
1. The optical system and the window are coated with anti-reflection material. When cleaning the glass surfaces, first blow away any dirt and dust. Fingerprints and lubricants can be wiped off with lens tissue or a soft cotton cloth, moistened with lens cleaning fluid or glass cleaner sold in any camera store. Always dampen the glass surfaces prior to cleaning. **To avoid damaging the window, never clean the glass surface with a dry cloth. It must be moistened with cleaning fluid, glass cleaner or an EOTECH LensPen.**
  2. No maintenance is needed on the sight's surface, except to occasionally wipe off with a damp, soft cloth. Use only a water-based cleaner such as glass cleaner, ammonia, or soap and water. **Never use any solvent-type cleaner such as alcohol or acetone to clean the sight's surface. Do not use gun cleaner to clean or lubricate the HWS.**
  3. All moving parts of the sight are permanently lubricated. **Do not try to lubricate them.**

## Operator Level Maintenance

The operator is limited to replacing batteries and cleaning the battery compartment and outer housing surfaces of the sight.

### Replacing the Battery

See the heading 'Replacing Battery' (*page 15*) under section 3, Getting Started.

### Battery Compartment Care

Do not use deteriorated or corroded batteries. Inspect battery for rips, tears, or cuts in the housing. If there is any exposed, internal content of the battery, it could potentially affect the operation of the sight.

### Outer Housing Care

See the heading 'Cleaning Instructions' (*page 20*) under section 4, Maintenance.

### The following items are authorized Customer Service parts that can be obtained from EOTECH:

- 2 × AA Alkaline Batteries
- Battery Cap
- Protective Hood and Hood Screws
- Hex Cross Bolt

See 'Service and Repair' (*page 24*) under section 5, Need Some Help.

### Troubleshooting

Measures the operator can take in the event of the named failure:

#### FAILURE

##### **The sight will not power up**

- Ensure that the sight is off (and not ON at a very low brightness Setting) by pressing both the UP and DOWN buttons simultaneously.
- Ensure the battery is inserted properly.
- Replace the battery with a new, unused batteries that contains a full charge.
- Inspect the battery contact points in both the battery cap and in the sight itself to ensure they are free of debris or corrosion.
- Reset the electronics by removing any source of power for approximately two (2) minutes. This will allow a capacitor in the electronics housing to drain of power, resetting the electronics. Reinstall the battery and operate the sight as normal.
- Check the battery contacts for corrosion or wear. Clean the contacts.
- Turn in the sight for maintenance.

#### FAILURE

##### **There is a streak in the reticle / the reticle is dim / the reticle fades in parts of the window**

- Replace the batteries.
- Prior to turning the sight in for repair, check with others who have used the sight and compare what you see to ensure it's not your focal acuity.
- Turn the sight in for maintenance.

#### FAILURE

##### **I am missing a bolt / have broken a bolt / have broken a latch**

- Turn the sight in for maintenance.

**FAILURE****The reticle is fuzzy / has a 'halo' effect / has more than one reticle**

The reticle is naturally pixilated and the outer circle will appear to be made up of many small dots. The center circle will still be distinguishable as one dot.

- Lower the brightness level of the reticle. This fault is generally caused by the reticle brightness being too high. The reticle is not designed to be so bright as to block the target.
- The reticle is projected onto your target plane. You must focus on it like you would any other object at that distance. Do NOT focus on the sight housing, rather, focus on your target. The outer ring is designed to be a reference to center, similar to a ghost ring.
- If you wear corrective lenses for nearsightedness, you will require them, not reading glasses, to see the reticle in focus, as it is projected onto the target plane. If you wear bifocals or have astigmatism, you may see a distorted reticle.
- Prior to turning the sight in for repair, check with others who have used the sight and compare what you see to ensure it's not your focal acuity.
- Turn the sight in for maintenance.

**FAILURE****The reticle is flashing / flashing on and off / unit turns off during recoil**

- This is the low battery indicator. Replace the batteries.
- If the batteries are low, a high recoil weapon platform can cause the reticle to flash on and off, even before the low battery indicator takes effect. Replace the batteries.
- Replace the batteries with a name brand which have proven to be the most effective to withstanding a consistent amount of recoil. Many brands of batteries deteriorate faster than others and can result in these failures.
- Turn the sight in for maintenance.

## Service and Repair

- Contact EOTECH's Customer Service Department at [eotechinc.com/help-center](http://eotechinc.com/help-center).
- Be sure to leave a name, contact number, return shipping address, and failure description in the email or on a voice mail. This will allow the manufacturer to generate a Return Authorization Number (RA#) to include with the sight(s).

---

**PRO TIP:** *Do not ship the sight(s) without a return authorization number – this will severely delay the turnaround time on repair or replacement.*

---

- If required, fill out a DD Form 1149 to include with the sight(s) you will return. Include a reference to the RA#, and a signature line for EOTECH's Service Department to sign indicating the receipt of materials. The signed copy will be mailed, faxed, or emailed back to you upon receipt of the sight(s) for the purposes of accountability.
- If the manufacturing date is more than five years old, a fee will be assessed for repair to include the cost of both parts and labor. A purchase order will be required to process the repair. Please contact EOTECH for an estimate.
- Please send the unit postage prepaid. Please include your name, address, telephone number, and a written description of the problem you are encountering, and also include the RA #. Whenever possible, ship the sight in its original box.

## Replacement Items

- To obtain replacement parts that are able to be field-installed for your HWS or Magnifier, please visit our Web page support link at [eotechinc.com](http://eotechinc.com).



## Contact Information

### **CUSTOMER SERVICE/REPAIR**

888-EOTHOLO  
[eotechinc.com/help-center](http://eotechinc.com/help-center)

### **RA# REQUEST WEB ADDRESS**

[eotechinc.com/help-center](http://eotechinc.com/help-center)

### **SHIPPING ADDRESS**

EOTECH  
46900 Port Street  
Plymouth, MI 48170 USA

SCAN FOR  
PRODUCT  
REGISTRATION



SCAN FOR  
WARRANTY  
INFORMATION





**Thank you for purchasing  
an EOTECH HWS**

N1979 Rev D | JANUARY 2022  
Proudly Made in Michigan, USA

[EOTECHINC.COM](http://EOTECHINC.COM)