U.S. Sporting Goods, Inc.

MODELS Z98 & Z99



Bolt Action Rifle

**WARNINGS AND
INSTRUCTION MANUAL**

**U.S. Sporting Goods, Inc.
1426 West King Street
Cocoa, FL 32922
www.eaacorp.com
Email: eaacorp@eaacorp.com
Phone: (321) 639-4842**

© Copyright 2009

U.S.SPORTING GOODS, INC. MODELS Z98 & Z99 BOLT ACTION RIFLE

WARNINGS AND INSTRUCTION MANUAL PLEASE READ THESE INSTRUCTIONS

MODEL NUMBER	BARREL LENGTH	CALIBERS
Z98 - Z99	20-24 Inches	25-06, 308, 243 30-06, 270, 7mm 223 Rem, 22 Hornet, 300WM, 375HH 222, 7.62x39, 22-250, 458 Win Mag
TYPE	FINISH	
BOLT ACTION RIFLE	BLUE OR STAINLESS STEEL	

GENERAL INFORMATION:

Weight (average) - 6.5 - 8.5 Lbs.

Overall Length - 39.5-44.25 inches

FOR YOUR SAFETY AND THE SAFETY OF OTHERS, this owner's manual contains important warnings and safety procedures which must be understood **BEFORE** using this firearm. Read the **ENTIRE MANUAL** and if you do not understand any part of it or the operation of your Bolt Action Rifle, stop and seek professional firearms instructions. You can get a copy of this manual from US SPORTING GOODS, Inc. on request.

Record the serial number of your firearm:

and a description of it:

Make a copy of this manual, proof of purchase/sales record for safekeeping in a secure safe or fireproof container. Such proof is necessary if the firearm is stolen or for warranty repair. Before handling any firearm, make sure you know the safety procedures and most importantly, keep the firearm pointed in a safe direction.

WARNING

****YOU RISK INJURY OR DEATH BY HANDLING THIS FIREARM****

Before handling this firearm, read, understand and follow the instructions in this manual. Always keep this manual with the firearm. If you lend, give or sell this firearm, be sure the manual goes with it. If there is anything you do not understand, seek advice from someone qualified in safe handling of firearms.

WARNING

This firearm should always be transported and stored unloaded in its case.

Type Of Ammunition To Be Used:

It is suggested that high quality commercially manufactured ammunition be used in this firearm. Some factory ammunition works better than others and you should stick with the brand you find works well in your Bolt Action Rifle. Avoid military surplus or hot loaded ammo. The use of reloaded, high pressure or hand loaded ammunition will void the warranty.

NOTICE

BOLT ACTION RIFLES ARE CLASSIFIED AS FIREARMS OR DANGEROUS WEAPONS and are sold by US SPORTING GOODS, Inc. with the specific understanding that we are not responsible in any manner what-so-ever for their safe handling or resale under local laws and regulations.

US SPORTING GOODS, Inc. shall not be responsible in any manner whatsoever for malfunctioning of the firearm, for physical injury or for property damage resulting in whole or in part from (1) intentional or negligent discharge, (2) improper or careless handling, (3) unauthorized modifications and/or alteration to the internal/safety mechanisms, (4) defective, improper, high pressure, handloaded, or reloaded ammunition, (5) corrosion and/or lack of proper maintenance (6) neglect, or (7) other influences beyond our direct and immediate control. This limitation applies regardless of whether liability is asserted on the basis of contract, negligence or strict liability (including any failure to warn). Under no circumstance shall US SPORTING GOODS, Inc. be liable for incidental or consequential damages, such as loss of use of property, commercial loss and loss of earnings or profits.

Safety Procedures:

1. We recommend that you get competent firearms instruction in safe handling before using this firearm. Please ask your dealer. All guns are extremely dangerous if carelessly handled or used. Remember that the firearm user is the primary “safety” and to depend on any mechanical devices is to be only half safe.
2. This firearm will fire if a cartridge is in the chamber and the trigger is pulled and the safety is disengaged.
3. DO NOT LOAD THIS BOLT ACTION RIFLE UNTIL YOU UNDERSTAND HOW THIS BOLT ACTION RIFLE OPERATES. KEEP this Bolt Action Rifle unloaded at all times except when ready to fire and you are sure of your target.
4. ALWAYS carry this Bolt Action Rifle in a case or original box unloaded.
5. NEVER point this Bolt Action Rifle at anything that is not your intended target even if this Bolt Action Rifle is unloaded. When loading, cleaning, unloading or handling, always be sure the muzzle is pointed in a safe direction and always keep your finger off the trigger.
6. NEVER assume any gun is unloaded. Before handling, check to make sure the chamber is empty. See unloading Instructions and then unload any ammunition. Make sure you know that this or any firearm is fully unloaded before displaying or handling it. When handling any firearm, keep your fingers away from the trigger at all times until you intend to fire.
7.  **WARNING:** The actual firearm does not contain any lead; however, it does fire ammunition containing lead or lead compounds known to the State of California to cause cancer, birth defects, reproductive toxicity, and other serious physical injury. Those who discharge a firearm, stand near someone who discharges a firearm or cleans firearms are hereby warned of the dangers presented by lead and lead compounds and should take protective health measures. Avoid exposure to lead while handling and wash your hands after contact. Proper air ventilation is absolutely necessary when shooting indoors.



AMMUNITION WARNING

Old, Hot-loaded and/or re-loaded ammunition may be dangerous. Because of the poor or nonexistent quality control standards among some companies or people who make reloaded ammunition and the dangers of overloads and under loads (squib loads) which may occur, we recommend that only good quality new factory ammunition be fired in our firearms. [If you prepare your own hand loads, do NOT exceed recommended pressures in line with those generated by standard factory loads as manufactured by Remington, Winchester, Federal, PMC or other reputable companies.] Old ammunition may not fire with sufficient force to expel the projectile from the barrel.

READING THESE SAFETY RULES WILL SAVE YOUR LIFE OR THE LIFE OF SOMEONE ELSE

Get instructions from a competent firearms instructor before using this or any firearm. Learn from a professional how to handle, load, unload, operate, fire and care for your gun.

NEVER PLAY with your firearm. It is not a toy and can be a very dangerous weapon that can cause serious personal injury or death.

Always keep the gun pointed in a safe direction. Treat every gun as if it is loaded...all the time. NEVER point any firearm (loaded or unloaded) at any person or anything you do not intend to shoot. Always keep your gun unloaded until ready to use and make sure that it is unloaded before cleaning.

Keep your finger OFF the trigger until you are actually aiming at the target and ready to shoot. Learn to rest your finger outside of the trigger guard.

Never rely on a gun's "safety" to protect you from unsafe gun handling. A safety is only a mechanical device, not a substitute for common sense and gun safety procedures.

Never leave a gun unattended or where it could fall and fire.

Store guns and ammunition separately **beyond the reach of children**. Make sure that they are properly secured so untrained individuals and children will be denied access to your guns and ammo.

Test your gun's operation and safeties only at a shooting range while the firearm is pointed in a safe direction.

Know your target and what is beyond. Ask yourself what your bullet will hit if it misses the target or passes through the intended target. Remember, a fired projectile can travel over a mile (including a ricochet) and is capable of going through walls.

Guns and alcohol or drugs do not mix. Don't take any alcoholic beverages and/or drugs before or during shooting activities.

Never pull a gun toward you by the muzzle. Don't climb a tree, cross a ditch or fence with a loaded gun.

Always empty guns before entering a house, car, truck, boat, RV, camp or any building.

When receiving a gun, always open the action and check to make sure the chamber is unloaded.

NEVER accept anyone's word that a gun is "unloaded" or "empty". You should immediately open the action and check to make sure it is unloaded.

**READING THESE SAFETY RULES WILL SAVE YOUR LIFE
OR THE LIFE OF SOMEONE ELSE**

Be careful with ALL ammunition. Even “blank” cartridges are deadly at close range due to the muzzle blast. Make sure your ammunition is in new and in good clean condition. Do NOT oil or grease ammo as this may damage the cartridge primer. Do NOT tamper with or alter the standard factory ammunition.

Keep firearms unloaded when not actually in use. Load the gun only when on the range preparing to fire and unload it before leaving the range.

Never put your hand over the muzzle of a gun.

ALWAYS WEAR protective shooting glasses and hearing protection when using firearms.

Spectators should be at least 10 feet behind and away from the shooter while the shooter is loading, shooting and unloading. Spectators should wear protection for hearing and sight loss and they should avoid distracting those shooting their firearms.

Never drop your gun. If you do drop it, unload it and check it for proper function before using it again.

Do NOT alter or modify your gun. Don't try to change your gun's trigger pull, because it may affect sear engagement and thereby cause accidental firing.

Do NOT remove any internal safety or safety device on the firearm. Safety mechanisms are designed to protect you from injury or death.

Do maintain and keep your gun clean. Keep in a dry place away from other metals and water. If your gun shows sign of corrosion or improper operation, have it serviced by a competent gunsmith.

Keep the muzzle pointed in a safe direction when loading and unloading your gun. Never point the muzzle at anyone.

Never shoot at hard flat surfaces or water...bullets ricochet.

If a gun fails to fire when the trigger is pulled, keep it pointed down range at the target for 60 seconds. Sometimes slow primer ignition will cause a “hang fire” and the cartridge will go off after a short pause. If it still fails to fire, keep muzzle pointed in safe direction and avoid exposure to the breech, as you attempt to unload your firearm.

Never let water, snow, mud or other material enter the barrel. Always be sure the barrel is free of any obstruction.

READING THESE SAFETY RULES WILL SAVE YOUR LIFE OR THE LIFE OF SOMEONE ELSE

Since many ammunition identifications sound similar, be sure that you use only the correct ammunition for your gun. Do NOT use the wrong size or wrong strength ammunition in your firearm.

Repeated and prolonged exposure to gunfire may cause toxic levels of lead in your body. High levels of lead in the blood may result in cancer, impotency, birth defects and other serious physical injury. When shooting indoors, make sure there is proper fresh air ventilation.

Teach children: 1. NOT to touch guns, bullets, cartridges, shells, flares or any explosive device and 2. If they discovery such a dangerous item or weapon, they must immediately report its location to their parents, school teacher or police.

Remember a firearm has the capability of taking your life or the life of someone else. Be careful with your firearm — an accident is almost always the result of not following basic safety rules.

HOME SAFETY IS PROBABLY YOUR BIGGEST CONCERN. We suggest a gun lock such as Master Gun Locks. They work on most firearms and are available in gun shops and sporting goods departments. For more information write: Master Gun Locks; Master Lock Company, P.O. Box 10367, Milwaukee, WI 53210. You have invested this much in your new firearm, now invest a little more in your family's safety.

USED FIREARMS If you got your US Sporting Goods, Inc. firearm as a used gun, BEFORE USING IT you should unload it and check all its functions to be sure it works correctly. Firearms are sometimes altered to work incorrectly, or parts may be removed, lost or replaced with incorrect parts. First, unload it and check it yourself and then take it to a good gunsmith who knows US Sporting Goods, Inc. firearms, and have him examine it.

WRITE US concerning any items or circumstances which you don't understand and which might relate to your safety and the operation of your firearm.

WARNING

BEFORE LOADING or firing a Bolt Action Rifle, examine the bore and the firing chamber to be certain they are clean and free of any obstruction. Even a heavy coat of oil, grease, snow or water may result in damage to the firearm and injury to the shooter and/or persons near the firearm. A misfire or unusual sound upon firing is a signal to cease firing and to examine the chamber and bore. If there is any obstruction, clear the obstruction and clean the bore and chamber before firing.

FIRING WARNING

When shooting, full eye and ear protection is mandatory at all times. Shooters and spectators must wear shooting glasses and sound suppressor to prevent eye injury and hearing loss. ***Vision loss and hearing impairment can occur with only one moment of non-protection.***

WARNING

Any bore obstruction, even if it is only partly blocked, may cause the gun to blow up if it is fired, or may cause damage to the gun such as a bulged barrel. To avoid injury or death to the shooter or bystanders, check the barrel before shooting or if a shot does not sound normal.

WARNING

Always keep the muzzle pointed in a safe direction! Never attempt to load or unload any firearm inside a vehicle, building or other confined space (except a properly constructed shooting range). Enclosed areas frequently offer no completely safe direction in which to point the firearm. If an accidental discharge occurs, there is great risk of injury or property damage. Before loading, always clean all, grease and oil from the bore and chamber, and check to be certain that no obstruction is in the barrel. Any foreign matter in the barrel could result in a bulged or burst barrel or other damage to the firearm and could cause serious injury to the shooter or to others.

WARNING

If there is any reason to suspect that a bullet or projectile is obstructing the barrel, immediately unload the firearm (See Unloading Instructions) and check the chamber and the bore. A bullet may be lodged some distance down the barrel where it can not easily be seen. Check the bore by using a cleaning rod to pass through the barrel. If a blockage is in the bore, **DO NOT ATTEMPT TO SHOOT IT OUT WITH ANOTHER CARTRIDGE, OR BLOW IT OUT WITH A BLANK CARTRIDGE OR A CARTRIDGE FROM WHICH THE BULLET HAS BEEN REMOVED. SUCH TECHNIQUE(S) CAN GENERATE EXCESSIVE PRESSURE, DAMAGE THE FIREARM AND CAUSE SERIOUS PERSONAL INJURY.** If the blockage can be removed with a cleaning rod, clean any unburned powder grains from the bore, chambers & mechanism before resuming shooting. If the blockage can not be dislodged by tapping it with a cleaning rod, take the firearm to a gunsmith.



WARNING (Mechanical Malfunctions)

STOP SHOOTING IMMEDIATELY AND UNLOAD YOUR FIREARM if your firearm develops: a mechanical malfunction; binding or stoppage; spitting powder/gas; a cartridge primer is punctured; a cartridge case is bulged or ruptured; or the sound on firing does not sound quite right. Do NOT try one more shot but unload your firearm and take it and the ammunition to a qualified gunsmith or send it back to USSG for examination. Do not assume that the Bolt Action Rifle is empty merely because you checked the chamber. You must also check the bore for any fired cartridge jammed inside the barrel.

External Control Parts:

Bolt Stop

Located on left hand side of receiver, Pull out to remove or install bolt

Bolt

The bolt has been packaged separately in the shipping carton. The bolt should be cleaned and lightly oiled before its initial use. You must become familiar with installing and removing the bolt properly. NEVER attempt to install or remove the bolt on a loaded firearm. Completely unload the firearm (empty chamber and magazine) before installing or removing the bolt.

Bolt Installation

1. Before inserting the bolt for the first time, make sure the firing pin is cocked (as supplied by the factory).

(See Pictures 6 & 7 in the section on the Safety Mechanism)

2. Make certain the claw extractor is aligned with the right-hand cocking lug on the bolt.

(See Pictures 1a & 1b)

Correct

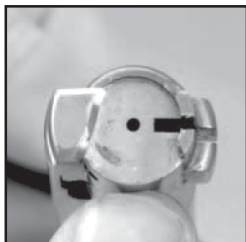

Picture 1a

Incorrect

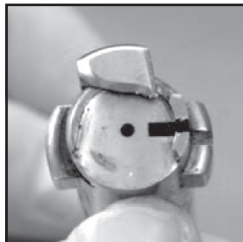

Picture 1b

Note: Model 799 actions do not utilize a rotating claw extractor

The bolt guide must be aligned with the locking lug on the same side as the bolt handle. (See Pictures 2a & 2b)

Correct

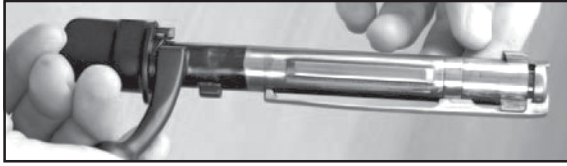

Picture 2a

Incorrect

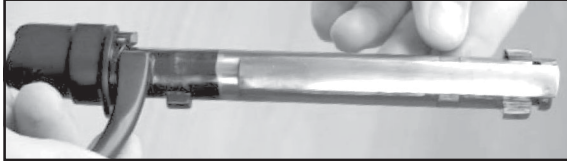

Picture 2b

3. Insert the bolt into the receiver aligning the lugs on the bolt with the lug tracks in the receiver. With the left hand, swing the bolt release lever open and push the bolt fully forward through the channel in the receiver. (See Picture 3)

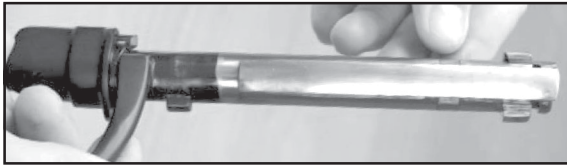

Picture 3

Release the bolt release lever after the lugs on the bolt clear the box. Lower the bolt handle all the way down into the locked position. The firing pin is now cocked and the safety mechanism may be placed in the “safe” position.

Bolt Removal

1. Raise the bolt handle and pull the bolt fully to the rear.
2. With the left hand, swing the bolt release lever open and pull the bolt further rearward through the channel in the receiver. (See Picture 4)

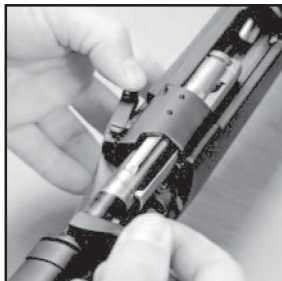

Picture 4

WARNING

The bolt has been fitted at the factory to assure proper head space when used with this particular rifle. Never interchange bolts from one rifle to another as this may affect head space leading to a potentially hazardous situation. If your bolt is damaged or lost, return your rifle to the factory for replacement with a properly fitted bolt.

Safety Mechanism

1. The safety mechanism is located on the right side of the receiver just behind the bolt handle.
(See Picture 5)

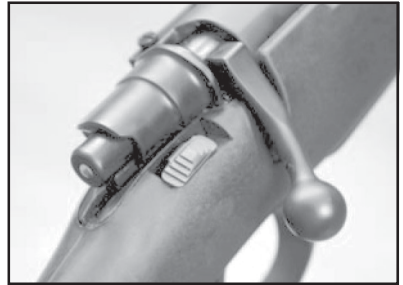

Picture 5

The safety mechanism can be placed in the “safe” position only when the firing pin is cocked. To cock the firing pin, lift the bolt handle fully and then lower it back to the locked position. When the firing pin is cocked, the rear of the firing pin mechanism protrudes from the back of the bolt. (See Picture 6 & 7)

Firing Pin Not Cocked

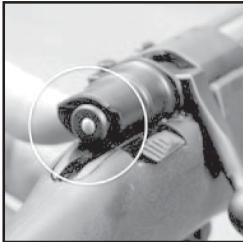

Picture 6

Firing Pin Cocked

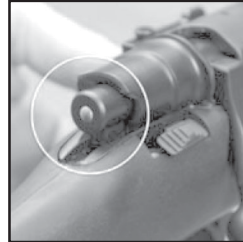

Picture 7

NOTE:

On the Model Z99 rifle, the firing pin mechanism protrudes slightly from the back of the bolt even when the firing pin is not cocked. Once the firing pin is cocked, the firing pin mechanism protrudes to the rear to a greater extent.

Trigger

The trigger mechanism has been preset at the factory. Never alter or modify the trigger or firing mechanism.

SAFETY OPERATING INSTRUCTIONS

Engage the safety mechanism in the “safe” position, pull the safety to its most rearward position, covering the red indicator dot on the stock. (See Picture 8)

To place the safety mechanism in the “fire” position, push the safety fully forward, exposing the red indicator dot on the stock. The rifle is now ready to fire by pulling the trigger. (See Picture 9)

“SAFE” Position

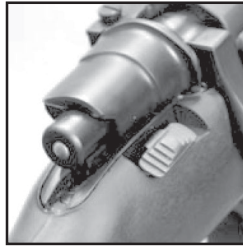

Picture 8

“FIRE” Position

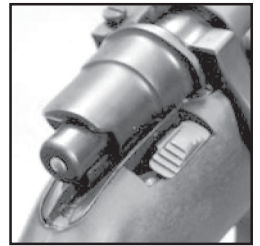

Picture 9

⚠ WARNING: Some of the metal parts of your rifle have had a rust preventative compound applied at the factory to protect the metal during shipment. Before shooting your rifle for the first time, you must clean the anti-rust compound from the barrel, receiver, breech bolt mechanism, and the action/chamber areas. To clean the barrel, refer to the Cleaning Instructions in this Owner’s Manual. Z98 rifles are manufactured with either a hinged floor plate magazine or a detachable box magazine.

Before loading your rifle for the first time, make sure (1) you have read and understand all of the warnings and instructions in this Owner’s Manual, and (2) you have removed all grease and oil from the barrel and chamber and any obstructions from the barrel.

Loading a Rifle With a Hinged Floor Plate

⚠ WARNING: Make sure the ammo that you are using is the correct caliber as identified on the receiver or barrel.

1. Keep the rifle pointed in a safe direction throughout the loading process.
2. Make sure the safety mechanism is engaged in the “safe” position.
3. Lift the bolt handle and pull the bolt all the way to the rear. (See Picture 10)

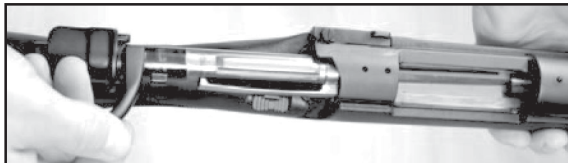

Picture 10

4. Place a cartridge in the receiver just forward of the bolt. Press the cartridge downward with your thumb until it snaps into the magazine. (See Picture 11)

5. Press each successive cartridge into the magazine in a similar fashion.

6. When the magazine is loaded to capacity, one additional cartridge may be loaded directly into the chamber. To accomplish this, insert the round directly into the chamber, and then press down on the top cartridge in the magazine as you close the bolt. (See Picture 12)

7. Your rifle is now in the ready-to-fire condition, loaded with a round in the chamber and a full magazine.

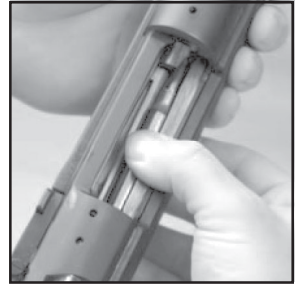

Picture 11

NOTE:

Single loading: Your rifle may be loaded with a single round in the chamber and no cartridges in the magazine. To single-load the rifle, simply skip Steps 4 and 5 above.

Loading the magazine only: Your rifle may be loaded with no round in the chamber and a full magazine. To accomplish this type of loading, follow Steps 1 through 5 above. Then do not load a round directly into the chamber and press down on the top cartridge of the magazine as you slide the bolt closed over that cartridge. The bolt will now be closed over an empty chamber. A round may subsequently be loaded into the chamber for firing by opening and fully retracting the bolt and then closing the bolt, stripping off the top cartridge from the magazine into the chamber.

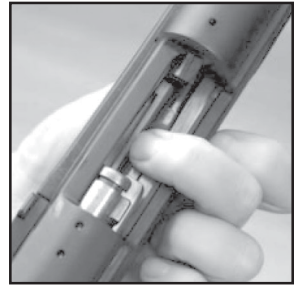

Picture 12

Loading a Rifle With a Detachable Box Magazine

⚠ WARNING: Make sure the ammo that you are using is the correct caliber as identified on the receiver or barrel.

1. Keep the rifle pointed in a safe direction throughout the loading process.
2. Make sure the safety mechanism is engaged in the "safe" position.
3. Lift the bolt handle and pull the bolt all the way to the rear.
4. Depress the magazine latch in front of the trigger guard, allowing the magazine to be pulled out of the bottom of the receiver. (See Picture 13)



Picture 13

5. Place a cartridge on top of the follower of the magazine and press down on the cartridge until it is retained in the magazine. Carefully position the cartridge so that its base is flush with the rear of the magazine. (See Picture 14)



Picture 14

6. Place each successive cartridge in the magazine as described in Step 4, until the magazine is full.

7. Insert the magazine back into the magazine well of the receiver until it is retained by the magazine latch.

8. Insert one round directly into the chamber. Then press down on the top cartridge in the magazine as you close the bolt over the top of that cartridge. (See Picture 15)

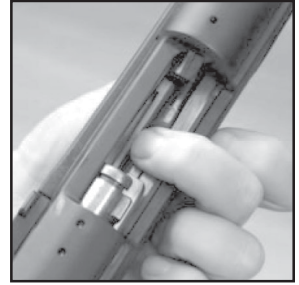

Picture 15

9. Your rifle is now in the ready-to-fire condition, loaded with a round in the chamber and a full magazine.

NOTE:

Single loading: Your rifle may be loaded with a single round in the chamber and no cartridges in the detachable box magazine. To single-load the rifle, simply skip Steps 4 through 7 above.

Loading the magazine only: Your rifle may be loaded with no round in the chamber and a full magazine. To accomplish this type of loading, follow Steps 1 through 7 above. Then do not load a round directly into the chamber and press down on the top cartridge of the magazine as you slide the bolt closed over that cartridge. The bolt will now be closed over an empty chamber. A round may subsequently be loaded into the chamber for firing by opening and fully retracting the bolt and then closing the bolt, stripping off the top cartridge from the magazine into the chamber.

WARNING

Your rifle may fire a chambered round even if the detachable box magazine has been removed from the rifle. Never assume the rifle is unloaded merely because you have removed the magazine.

Firing the Rifle

Once a cartridge has been loaded into the chamber, the rifle is ready to be fired.

1. Aim the rifle at your intended target, with the butt of the rifle planted firmly against your shoulder.
2. Keeping your fingers away from the trigger, push the manual safety forward to the "fire" position.
3. Put your trigger finger on the trigger and slowly squeeze or pull the trigger to fire the rifle.

NOTE: Unless you intend to fire another shot right away, leave the bolt closed over the fired cartridge.

4. To extract and eject the fired cartridge case, lift the bolt handle and pull the bolt all the way to the rear.

5. Closing the bolt will then chamber the next cartridge from the magazine. Unless you intend to fire an immediate next shot, pull the safety fully to the rear to the “safe” position. Your rifle is now loaded with another round in the chamber.

⚠ WARNING: Never keep or store your rifle loaded..... There is no excuse for not being careful.....

⚠ WARNING: Never load a shell or cartridge into the chamber until you are ready to fire the Bolt Action Rifle...

⚠ WARNING

- Do not disengage the safety until the Bolt Action Rifle is pointed in a safe direction and you are ready to fire.
- If a cartridge does not fire and the trigger has been pulled and the safety is disengaged...Stop! and do the following: a) Make sure the gun is pointed in a safe direction b) Engage the safety c) Wait 60 seconds d) Follow the instruction below for unloading the Bolt Action Rifle.
- If during firing the sound of any cartridge is noticeably softer or louder than the previous cartridge fired, Stop! Do not load another cartridge or fire another cartridge and do the following: a) Make sure the gun is pointed in a safe direction b) Engage the safety c) Follow the instruction below for unloading the Bolt Action Rifle d) With the Bolt Action Rifle unloaded visually inspect the Bolt Action Rifle for barrel blockage or damage and inspect the mechanical portion and receiver of the Bolt Action Rifle for damage before continuing.

Unloading a Rifle With a Hinged Floor Plate

1. Keep the muzzle pointed in a safe direction and your fingers away from the trigger throughout the unloading process.

2. Make sure the safety is engaged in the “safe” position.

3. Open the bottom magazine cover by depressing the release button allowing the magazine cover to swing open.

(See Picture 16)

4. The magazine spring and follower will be released from the magazine allowing the cartridges to empty out from the magazine into your hand. (See Picture 17)



Picture 16



Picture 17

⚠ WARNING: At this stage of the unloading process, your rifle still has a live round in the chamber which may be fired even though the magazine has been unloaded. Never assume your rifle cannot fire simply because the magazine is empty.



Picture 18

5. The magazine spring and follower will be released from the magazine allowing the cartridges to empty out from the magazine into your hand.

(See Picture 18)

6. With the bolt open (fully to the rear), look into the chamber and magazine well to make sure all cartridges have been unloaded from the rifle.

7. Reposition the magazine follower and magazine spring back into the magazine well. Close the hinged magazine cover making sure it latches securely into place.

8. With the bolt open (fully to the rear), visually recheck the chamber and magazine well to make sure the rifle is completely unloaded.

Unloading a Rifle With a Detachable Box Magazine

1. Keep the muzzle pointed in a safe direction and your fingers away from the trigger throughout the unloading process.

2. Make sure the safety is engaged in the “safe” position.

3. Depress the magazine latch in front of the trigger guard, allowing the magazine to be pulled out of the bottom of the receiver. (See Picture 19)



Picture 19



Picture 20

⚠ WARNING: At this stage in the unloading process, your rifle still has a live round in the chamber which may be fired even though the box magazine has been removed. Never assume your rifle cannot fire simply because the box magazine has been removed.

4. Lift the bolt handle and pull the bolt fully to the rear to remove the cartridge from the chamber.

(See Picture 20)

5. With the bolt open (fully to the rear), look into the chamber and magazine well to make sure all cartridges have been removed from the rifle.

6. Empty the cartridges from the box magazine in a reverse manner from the loading instructions. You may store the empty magazine separately or reinsert it into the rifle.
7. With the bolt still open, visually recheck the chamber and magazine well to make sure the rifle is completely unloaded.

CLEANING INSTRUCTIONS

⚠ WARNING: NEVER attempt to clean a loaded firearm. Make sure the rifle is completely unloaded (chamber and magazine empty) before cleaning.

Cleaning the Barrel

1. Make sure the safety is engaged in the “safe” position and your rifle is unloaded.
2. Remove the bolt from the rifle.
3. Select a cleaning rod and brush of the appropriate caliber for your rifle.
4. Soak the cleaning brush with a quality gun cleaning solvent or Bore Cleaner.
5. Push the cleaning rod and brush through the entire length of the barrel several times.
6. Remove the brush from the cleaning rod and attach a dry cleaning patch to the patch attachment.
7. Push the rod and dry patch through the entire length of the barrel several times. Repeat with another dry patch until the patch is no longer dirty.
8. Put a patch saturated with a quality gun oil on the rod tip.
9. Push the oiled patch through the barrel several times.
10. Remove the oiled patch from the rod tip, and insert another dry patch.
11. Push the dry patch through the barrel several times to remove any excess oil from the barrel.
12. When you have finished cleaning the interior of the barrel, visually check the bore to make sure no patches or other obstructions remain in the barrel.
13. Apply a thin coat of gun oil to the outside of the barrel with a soft clean cloth.

Cleaning the Action

1. Use a patch or soft clean cloth to clean powder residues and any other foreign materials from the bolt and receiver surfaces. To clean congealed lubricants or other hard to remove deposits, use a quality action cleaner. (See Picture 21)
2. Apply a light film of quality gun oil along the bolt and receiver surfaces. Avoid applying too much lubricant - only a light film is necessary.



Picture 21

 **WARNING:** Never attempt to take your rifle apart further than as set forth in the Owner's Manual. If further cleaning, service or repairs are needed, take your rifle to a competent gunsmith or return to US SPORTING GOODS, Inc. for service.

 **WARNING:** Lead or lead compounds are known to the State of California to cause cancer, birth defects, reproductive toxicity, and other serious physical injury. Those who clean firearms should take protective measures to avoid contact or exposure to such chemicals.

MANUFACTURER'S WARNING

This firearm was manufactured to properly perform with the original parts as designed. It is your duty to make sure any parts you buy are correctly installed and that neither replacements nor originals are altered or changed. Your gun is a complex tool with many parts that must relate correctly to other parts for safe and accurate operation. Putting a gun together wrong or with modified parts can result in a damaged gun, injury or death to you or others through malfunction. Always let a qualified gunsmith work on your gun or at least, check any work not performed by a gunsmith. Firearms safety is your primary concern. **THE GUN OWNER MUST ACCEPT FULL RESPONSIBILITY FOR THE CORRECT REASSEMBLY AND FUNCTIONING OF THE FIREARM AFTER ANY DISASSEMBLY OR REPLACEMENT OF PARTS.**

DANGER — AMMUNITION WARNING

Firearms may be damaged and serious injury or death to the shooter or bystander may result from any condition which contributes to the generation of excessive pressure or uncontrolled release of gas within the firearm. Such adverse conditions can be caused by bore or chamber obstruction, propellant powder overloads or by defective, incorrect or improperly loaded and assembled cartridge components. Even the strongest firearm can be blown up as a result of excessive pressure. It is extremely dangerous to use a cartridge whose pressure is greater than that developed by cartridges loaded to industry standards.

AMMUNITION (CARTRIDGES) NOTICE

We specifically disclaim responsibility for any damage, injury or death occurring in connection with or as the result of the use of Z98/Z99 Bolt Action Rifle of faulty, non-standard, remanufactured, hand loaded or reloaded ammunition, used cartridges or cartridges other than factory cartridges for which the firearm was originally chambered.



LUBRICATION WARNING

Firing a Bolt Action Rifle with oil, grease or any other material even partially obstructing the bore may result in damage to the Bolt Action Rifle and injury to the shooter and those nearby. Do not spray or apply lubricants directly on ammunition. If the powder charge of a cartridge is affected by the lubricant, it may not be ignited, but the energy from the primer may be sufficient to push the bullet into the bore where it may become lodged. Firing a subsequent bullet into the obstructed bore will damage the Bolt Action Rifle and may cause injury to the shooter and those nearby. Use lubricants properly. You are responsible for the proper care and maintenance of your firearm and ammunition.

ONE YEAR LIMITED WARRANTY

This US Sporting Goods, Inc. firearms is warranted to the original retail customer for One Year from date of purchase against defects in material and workmanship. All parts and labor or replacement **at our option** are covered. Wood Stock and Wood Forend are not covered by the One Year Warranty. The warranty on the wood stock and forend is 60 days from purchase and only covers manufactured and material defects.

Transportation to and from our repair facilities, government fees, damage caused by failure to perform normal maintenance, sales outside the United States, damage due to use of high velocity, high pressure, reloaded or other nonstandard ammunition, or any unauthorized repair, modification, misuse, abuse, or alteration of the product is not covered by this Limited Warranty.

Any implied warranties, including the implied warranties of merchantability and fitness for a particular purpose, are limited to one year from date of original retail purchase. Consequential or incidental damages and/or expenses, or any other expenses are not covered by this warranty.

To obtain warranty performance send your firearm with proof of retail purchase, freight prepaid to:

U.S. SPORTING GOODS, INC.
1426 West King Street
Cocoa, FL 32922



WARNING

Altering or modifying parts and/or internal safeties is dangerous and will void the warranty. This Bolt Action Rifle was manufactured to perform properly with the original parts as designed. It is your duty to make sure any parts you buy are made for this firearm and are installed correctly and that neither the replacements nor originals are altered or changed. Your gun is a complex precision tool with many parts that must relate correctly to other parts in order for proper and safe operation. Putting a gun together wrong or with incorrect or modified parts can result in a damaged gun, danger, and injury or death to you and others through malfunction. Always have a qualified gunsmith work on your gun or at least check any work not performed by a gunsmith.

MODEL Z98

BOLT ACTION CENTER FIRE RIFLE

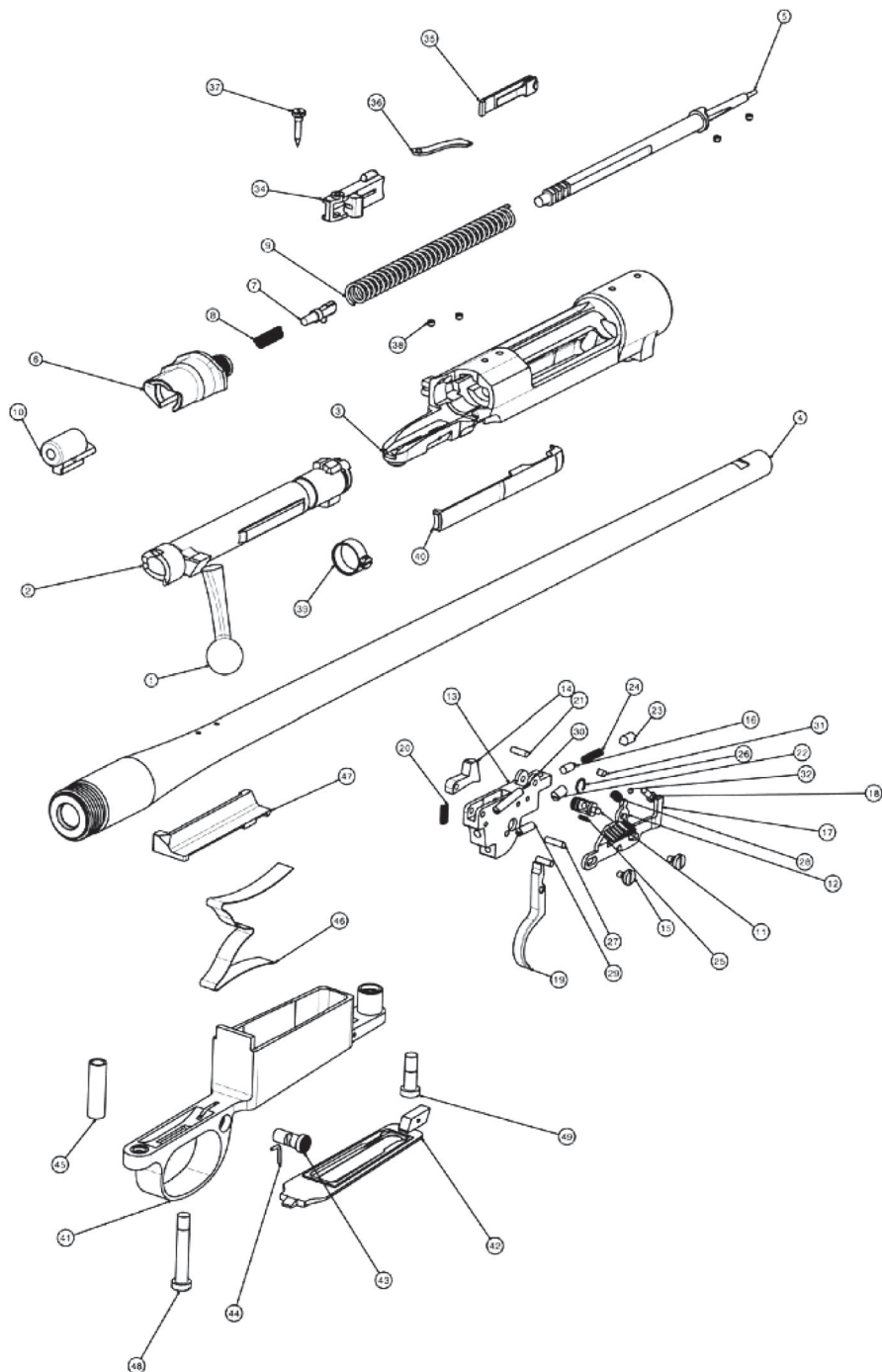

MODEL Z98
BOLT ACTION CENTER FIRE RIFLE

PARTS LIST

#	Part Name	#	Part Name
1,2	Bolt	28	Safety Spring
3	Receiver	29	Lower Screw
4	Barrel	30	Upper Screw
5	Firing Pin	31	Ball Screw
6	Bolt Sleeve	32	Ball
7	Bolt Sleeve Catch	33	Nut
8	Bolt Sleeve Catch Spring	34	Ejector Box
9	Firing Pin Spring	35	Ejector Box Spring
10	Cocking Piece	36	Ejector
11, 12	Safety	37	Ejector Box Screw
14	Sear	38	Screw
15	Safety Lever Screw	39	Extractor Ring
16	Pusher	40	Extractor
17	Safety Lever	41	Magazine
18	Safety Screw	42	Magazine Plate
19	Trigger	43	Magazine Plate Catch
20	Sear Spring	44	Locking Wire
21	Sear Pin	45	Tube
22	Screw	46	Follower Spring
23	Pusher Screw	47	Follower
24	Pusher Spring	48	Guard Screw, Rear
25	Ball Spring	49	Guard Screw, Front
26	Fixing Ring		
27	Sear Pin		

MODEL Z99

BOLT ACTION CENTER FIRE RIFLE

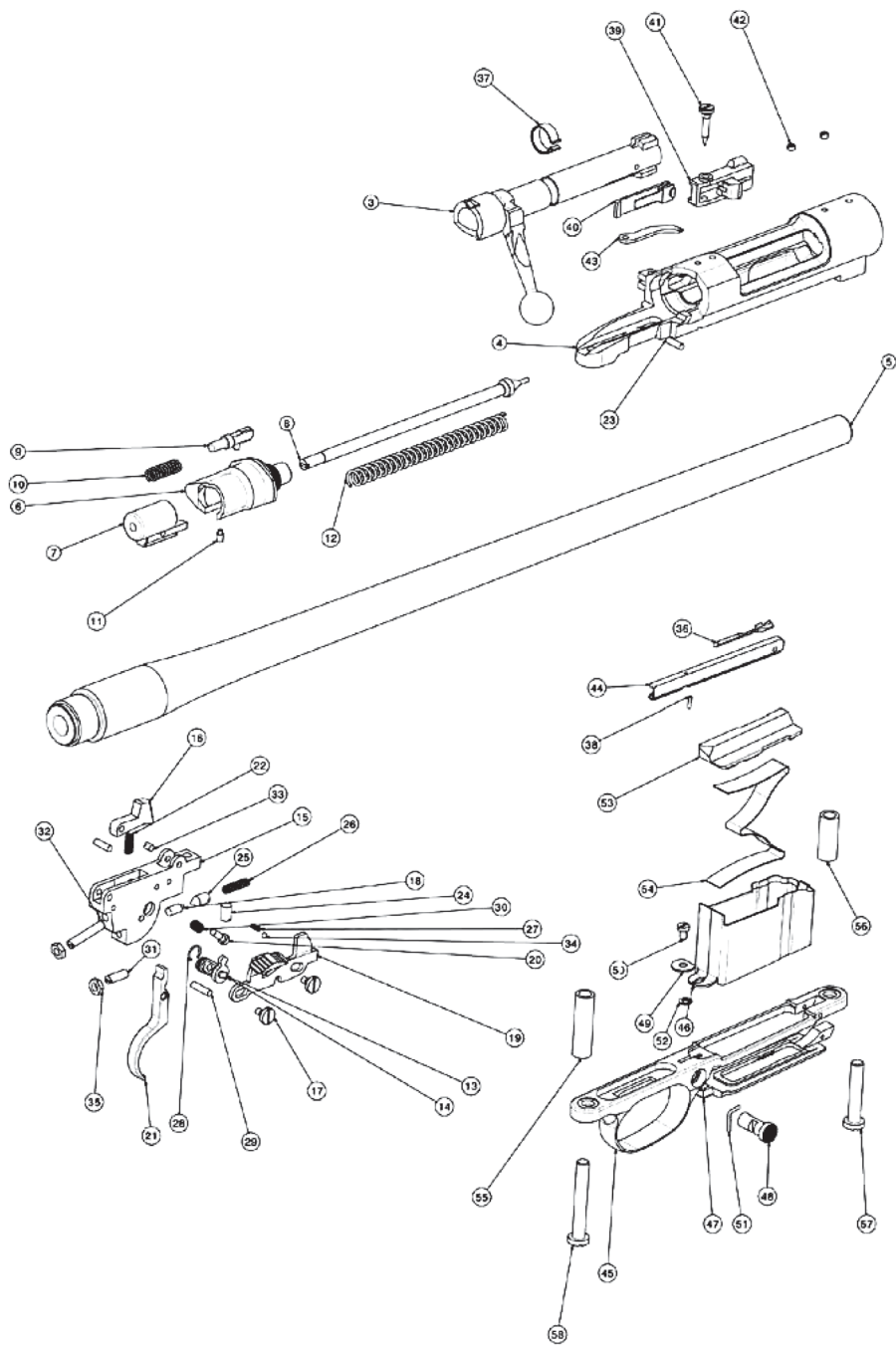

MODEL Z99
BOLT ACTION CENTER FIRE RIFLE

PARTS LIST

#	Part Name	#	Part Name
1	Bolt	32	Upper Screw
4	Receiver	33	Ball Screw
5	Barrel	34	Ball
6	Bolt Sleeve	35	Nut
7	Cocking Piece	36	Extractor
8	Firing Pin	37	Ring
9	Bolt Sleeve Catch	38	Bolt Guide Pin
10	Bolt Sleeve Catch Spring	39	Ejector Box
11	Sear Pin	40	Ejector Box Spring
12	Firing Pin Spring	41	Ejector Box Screw
13	Safety	42	Screw
14	Safety	43	Ejector
15	Housing	44	Bolt Guide
16	Sear	45	Trigger Guard
17	Safety Lever Screw	46	Magazine
18	Pusher	47	Magazine Plate
20	Safety Screw	48	Magazine Plate Catch
21	Trigger	49	Washer
22	Sear Spring	50	Magazine Screw
24	Screw	51	Locking Wire
25	Pusher Screw	52	Washer
26	Pusher Spring	53	Follower
27	Ball Spring	54	Follower Spring
28	Fixing Ring	55	Tube
29	Sear Pin	56	Tube Front
30	Safety Spring	57	Guard Screw, Front
31	Lower Screw	58	Guard Screw, Rear

YOUR OWNERS' MANUAL

Always keep this manual with your firearm. Make sure you understand all the warnings, operation instructions and safety procedures. When you lend, give or sell the firearm, be sure this manual goes with it. You can get a copy of this manual from European American Armory on request.

ALL PARTS ORDERS ARE SUBJECT TO A \$10.00 CHARGE FOR SHIPPING AND HANDLING. Please state Model, Caliber, Serial Number, and Finish Color when ordering. For parts, information and service contact: US SPORTING GOODS, Inc., 1426 West King Street, Cocoa, FL 32922. Phone: (321) 639-4842.



WARNING

Children are attracted to and can operate firearms that can cause severe injuries or death.

Prevent child access by always keeping guns locked away and unloaded when not in use. If you keep a loaded firearm where a child obtains and improperly uses it, you may be fined or sent to prison.



ADVERTENCIA

A los niños les atraen las armas de fuego y los pueden hacer funcionar. Ellos pueden causarse lesiones graves y la muerte.

Evite que los niños tengan acceso a las armas de fuego guardándolas siempre con llave y descargadas cuando no las esté utilizando. Si usted tiene un arma de fuego cargada en un lugar en que un niño tiene acceso a ella y la usa indebidamente. Le pueden dar una multa a enviarlo a la cárcel.

IMPORTER:

US SPORTING GOODS, INC.

1426 West King Street

Cocoa, FL 32922

www.eaacorp.com

Email: eaacorp@eaacorp.com

Phone: (321) 639-4842

Manufacturer:

Zastava Oruzje Ad

34000 Kragujevac, Trg topolivaca 4
Serbia