





OWNERS MANUAL

MC2c[®] COMPACT PISTOL
MC2sc[™] SUB-COMPACT PISTOL

IMPORTANT: "SAFETY WARNINGS" — NOTE THE SYMBOL 

THESE SAFETY WARNINGS ARE FOR YOUR PROTECTION AS WELL AS THE SAFETY OF OTHERS. DISREGARDING INFORMATION IN THIS MANUAL COULD CAUSE DEATH, SERIOUS INJURY OR PROPERTY DAMAGE TO YOU OR THOSE AROUND YOU.

 Do not attempt to load, handle or use your firearm until you read and understand the information contained in this owner's manual. Understand and follow all instructions and warnings in their entirety. Before handling your firearm, you should learn how it operates and how to maintain it. This includes knowing its basic parts, how the manual safety (if so equipped) and other safety features operate, how to safely open and close the action, and how to safely load and unload ammunition from the firearm. Improper use and handling is dangerous and could cause death, serious injury or property damage to you or those around you. All users of the firearm must become thoroughly familiar with the instructions in this manual.

 This manual is not a comprehensive guide to firearm safety. Mossberg recommends that new firearm owners and/ or shooters seek professional training from qualified instructors prior to handling any firearm.

 Be certain this owner's manual is available for reference and is kept with this firearm if transferred to another party. If this manual is lost or misplaced, contact the Product Service Center for a free replacement copy or visit www.mossberg.com.

 After performing any work on your firearm such as cleaning, adjustments, disassembly or installation of any accessory, the firearm should be re-checked for proper functioning before using and/or firing live ammunition.

 Firearms are complex mechanisms. Any modification, alteration, or improper fitting of parts may result in a dangerous malfunction, damage to the firearm, and could cause death, serious injury or property damage to you or those around you. The firearm's owner must accept full responsibility for the correct reassembly and functioning of the firearm after any disassembly or replacement of parts.

 If you do not understand any of the material in this manual or have any questions, contact the Product Service Center or a qualified gunsmith.

O.F. MOSSBERG & SONS, INC.

P.O. BOX 497 • 7 GRASSO AVENUE, NORTH HAVEN, CT 06473

PHONE (800) 363-3555

www.mossberg.com

Safety and safe firearms handling is everyone's responsibility.



As the owner of a firearm, you must undertake the full-time responsibility of safe firearms handling for your own safety and the safety of those around you:

- Keep all firearms and ammunition out of the reach of children, or any unauthorized person.
- Store your firearms and ammunition separately, locked in a secure location.
- Be sure to read how to properly install your cable lock as instructed in this manual.
- Never store a loaded firearm.
- Never leave a loaded firearm unattended.
- Never transport a loaded firearm in a vehicle. When transporting your firearm, keep it unloaded, stored and secured within the confines of the vehicle.
- Unload your firearm when you have stopped shooting or when you have to climb a tree, fence or cross a slippery surface. Keeping your firearm unloaded when not in use will prevent an unintentional discharge should you accidentally slip, fall, drop or jar your firearm.
- The safety (if so equipped) should remain fully in the “ON” (SAFE) position and the firearm unloaded at all times until you are in a place where it is safe to shoot, keeping your finger off the trigger and outside the trigger guard until you are aiming at the intended target and have decided to fire.
- Never shoot at water, rocks, or any hard surfaces. Shots may glance off or ricochet off such surfaces and could cause death, serious injury or property damage to you or those around you.
- Be sure of your target and beyond. Make sure that your back stop is adequate to stop bullets prior to firing.
- Do not use alcohol or drugs before or while handling firearms.
- Do not touch the trigger while the safety is being engaged or disengaged.



Remember, a firearm’s manual safety is a mechanical device which can never replace safe firearm handling practices.



Never rely on any mechanical mechanism or safety device to prevent the dangers of careless handling or pointing a firearm in an unsafe direction.



Always point the muzzle of your firearm in a safe direction, regardless of whether the firearm is loaded or unloaded. You should become thoroughly familiar with the function and operation of this firearm and the instructions supplied with it.



Always treat every firearm as if it is loaded. Give your firearm to someone with the magazine removed, the action open (slide locked rearward), and the safety (if so equipped) fully to the “ON” (SAFE) position, after you verify the firearm is unloaded. Insist on the same procedure when receiving a firearm from someone else. Learn the location of all the safety features of your firearm and how they operate.



Never place your finger inside the trigger guard or on the trigger unless you intend to fire. When you pull the trigger you must expect the firearm to fire and you must take full responsibility for your actions.



It is recommended that you should have training from a qualified instructor prior to holstering, drawing and carrying a loaded firearm. You should never carry this firearm loaded unless you have obtained such training. Failure to do so could result in an unintentional discharge.





Always wear eye and ear protection when firing a firearm. Firing a firearm without proper ear protection can cause hearing loss. The use of eye protection during any type of shooting, disassembly, assembly and cleaning is important to protect your vision.



We specifically disclaim any responsibility for damage or injury whatsoever occurring in connection with, or as a result of, the use of faulty, or non-SAAMI standard, or “remanufactured”, or hand-loaded (reloaded) ammunition. Additionally, we disclaim any responsibility for damage or injury which results from any modifications or changes that are not a part of the firearm as delivered from the factory.



Always ensure that barrel and action are clear of obstructions before firing. Firing a blocked firearm could cause death, serious injury, or property damage to you or those around you.



Never force a jammed action. This could cause a cartridge to explode resulting in death, serious injury or property damage to you or those around you.



Should any cartridge fail to fire, keep the muzzle pointed in a safe direction for at least thirty (30) seconds in case the cartridge is a “hangfire” (delayed firing of the cartridge after being struck by the firing pin.) Then, remove the magazine (as it may still have loaded cartridges in it), pull the slide fully rearward, lock the action in the open position and extract and eject the misfired cartridge. Segregate the misfired cartridge from other ammunition. Do not attempt to refire a misfired cartridge. If the indent from the firing pin is light or absent, contact a qualified gunsmith or the Product Service Center.



Do not drop, or allow anything to strike the firearm because, as with any firearm, an accidental discharge may result.



Learn to clean your firearm thoroughly and make certain no oil, grease or other materials are blocking the barrel. Obstructions of any kind can cause death, serious injury or property damage.



Practice proper firearm maintenance and safety. Make sure all exposed metal surfaces are coated with a thin film of oil, especially after being exposed to damp weather. (See the proper section of this manual for cleaning instructions.) Do not plug the barrel or store in a fabric-lined case, which will absorb lubricants from the firearm. Always store this firearm with the chamber empty and magazine unloaded. Failure to do so could result in an unintentional discharge.



Before using the firearm after storage, follow complete instructions stated in this manual for re-familiarization with the firearm. A thorough inspection and function test should be performed before going into the field. Have your firearm periodically checked by a qualified gunsmith.





STATE-BY-STATE WARNINGS

Certain states require, by law, that their own specified warning notices, in larger-than-normal type be conspicuously included by the manufacturer, distributor, or retail dealer with firearms sold in that state. O.F. Mossberg & Sons, Inc. (“Mossberg”) sells its products in compliance with applicable laws and regulations. Because our products may be sold in these states, we include the following:



CALIFORNIA:

Firearms must be handled responsibly and securely stored to prevent access by children and other unauthorized users. California has strict laws pertaining to firearms, and you may be fined or imprisoned if you fail to comply with them. Visit the Web site of the California Attorney General at <https://oag.ca.gov/firearms> for information on firearm laws applicable to you and how you can comply. Prevent child access by always keeping guns locked away and unloaded when not in use. If you keep a loaded firearm where a child obtains and improperly uses it, you may be fined or sent to prison.



ADVERTENICA:

Las armas de fuego deben manipularse de manera responsable y segura para evitar el acceso de niños y otros usuarios no autorizados. California tiene leyes estrictas relacionadas con armas de fuego, y usted puede ser multado o encarcelado si no las cumple. Visite la pagina web del Procurador General de California en <https://oag.ca.gov/firearms> para obtener información sobre las leyes de armas de fuego que le son aplicables y cómo puede cumplirlas. Evite el acceso de niños manteniendo siempre las armas bloqueadas y descargadas cuando no estén en uso. Si mantiene un arma de fuego cargada donde un niño obtiene y la usa indebidamente, se le puede multar o enviar a prisión.



CONNECTICUT:

“UNLAWFUL STORAGE OF A LOADED FIREARM MAY RESULT IN IMPRISONMENT OR FINE.”



**FLORIDA:**

“IT IS UNLAWFUL, AND PUNISHABLE BY IMPRISONMENT AND FINE, FOR ANY ADULT TO STORE OR LEAVE A FIREARM IN ANY PLACE WITHIN THE REACH OR EASY ACCESS OF A MINOR UNDER 18 YEARS OF AGE OR TO KNOWINGLY SELL OR OTHERWISE TRANSFER OWNERSHIP OR POSSESSION OF A FIREARM TO A MINOR OR A PERSON OF UNSOUND MIND.”

**MAINE:**

“ENDANGERING THE WELFARE OF A CHILD IS A CRIME. IF YOU LEAVE A FIREARM AND AMMUNITION WITHIN EASY ACCESS OF A CHILD, YOU MAY BE SUBJECT TO FINE, IMPRISONMENT OR BOTH. KEEP FIREARMS AND AMMUNITION SEPARATE. KEEP FIREARMS AND AMMUNITION LOCKED UP. USE TRIGGER LOCKS.”

**MARYLAND:**

“WARNING: Children can operate firearms which may cause death or serious injury. It is a crime to store or leave a loaded firearm in any location where an individual knew or should have known that an unsupervised minor would gain access to the firearm. Store your firearm responsibly!”



**MASSACHUSETTS:**

“WARNING FROM THE MASSACHUSETTS ATTORNEY GENERAL: This handgun is not equipped with a device that fully blocks use by unauthorized users.

More than 200,000 firearms like this one are stolen from their owners every year in the United States. In addition, there are more than a thousand suicides each year by younger children and teenagers who get access to firearms. Hundreds more die from accidental discharge. It is likely that many more children sustain serious wounds, or inflict such wounds accidentally on others. In order to limit the chance of such misuse, it is imperative that you keep this weapon locked in a secure place and take other steps necessary to limit the possibility of theft or accident. Failure to take reasonable preventative steps may result in innocent lives being lost, and in some circumstances may result in your liability for these deaths.”

“IT IS UNLAWFUL TO STORE OR KEEP A FIREARM, RIFLE, SHOTGUN OR MACHINE GUN IN ANY PLACE UNLESS THAT WEAPON IS EQUIPPED WITH A TAMPER RESISTANT SAFETY DEVICE OR IS STORED OR KEPT IN A SECURELY LOCKED CONTAINER.”

**NEW JERSEY:**

“IT IS A CRIMINAL OFFENSE TO LEAVE A LOADED FIREARM WITHIN EASY ACCESS OF A MINOR.”



**NEW YORK CITY:**

"THE USE OF A LOCKING DEVICE OR SAFETY LOCK IS ONLY ONE ASPECT OF RESPONSIBLE WEAPON STORAGE. ALL WEAPONS SHOULD BE STORED UNLOADED AND LOCKED IN A LOCATION THAT IS BOTH SEPARATE FROM THEIR AMMUNITION AND INACCESSIBLE TO CHILDREN AND ANY OTHER UNAUTHORIZED PERSONS. NEW YORK CITY LAW PROHIBITS, WITH CERTAIN EXCEPTIONS, ANY PERSON FROM ACQUIRING MORE THAN ONE FIREARM, OR MORE THAN ONE RIFLE OR SHOTGUN, WITHIN A 90-DAY PERIOD."

**NORTH CAROLINA:**

"IT IS UNLAWFUL TO STORE OR LEAVE A FIREARM THAT CAN BE DISCHARGED IN A MANNER THAT A REASONABLE PERSON SHOULD KNOW IS ACCESSIBLE TO A MINOR."

Any person who resides in the same premises as a minor, owns or possesses a firearm, and stores or leaves the firearm (i) in a condition that the firearm can be discharged and (ii) in a manner that the person knew or should have known that an unsupervised minor would be able to gain access to the firearm, is guilty of a Class 1 misdemeanor if a minor gains access to the firearm without the lawful permission of the minor's parents or a person having charge of the minor and the minor:

- (1) Possesses it in violation of G.S. 14-269.2(b);
- (2) Exhibits it in a public place in a careless, angry, or threatening manner;
- (3) Causes personal injury or death with it not in self defense; or
- (4) Uses it in the commission of a crime.





TEXAS:

“IT IS UNLAWFUL TO STORE, TRANSPORT, OR ABANDON AN UNSECURED FIREARM IN A PLACE WHERE CHILDREN ARE LIKELY TO BE AND CAN OBTAIN ACCESS TO THE FIREARM.”



WISCONSIN:

“IF YOU LEAVE A LOADED FIREARM WITHIN THE REACH OR EASY ACCESS OF A CHILD YOU MAY BE FINED OR IMPRISONED OR BOTH IF THE CHILD IMPROPERLY DISCHARGES, POSSESSES, OR EXHIBITS THE FIREARM.”





A note about the warnings and information contained in this manual:

The above warnings are not intended to be exhaustive. We strongly suggest that you check with your local licensed retailer or state police for additional information concerning firearms ownership, or hunting or target shooting rules that may be required by local law or regulation. Since such rules and regulations are subject to change, local authorities are in the best position to advise you on such matters.

TABLE OF CONTENTS

	Page
General Information and Mechanical Characteristics	10-11
Loaded Chamber View Port	12
Safety Operation	13-14
Bladed Trigger	14
Opening the Action	15
Removing and Installing the Magazine	16
Loading the Firearm	17-18
Firing	18-21
To Clear A Malfunction (“Jam”)	21
Unloading the Firearm	22
Disassembly	22-23
Cleaning and Lubrication	24-26
Assembly	26-27
Function Testing	28
Sight Adjustments	29-31
Reversing the Magazine Release	32
Reversing the Manual Safety	33
Storage	34
Cable Lock	35
Service Instructions	36
Warranty Information	37-38
Parts List, MC2c [®] , MC2sc [™]	39
Exploded View, MC2c [®] , MC2sc [™]	40
Parts List and Exploded View, Magazine	41
Notes	42- 43
Basic Rules of Safe Firearms Handling	Back Cover



WARNING: This product can expose you to chemicals, including lead, which are known to the State of California to cause cancer and birth defects or other reproductive harm. For more information go to www.P65Warnings.ca.gov.





GENERAL INFORMATION AND MECHANICAL CHARACTERISTICS

This firearm is designed to operate with 9mm Luger or 9mm Luger “Plus-P” (+P) ammunition only.



DO NOT USE “PLUS-P-PLUS” (+P+) AMMUNITION IN THIS FIREARM. PRESSURES GENERATED COULD EXCEED SAAMI MAXIMUMS AND COULD CAUSE DEATH, SERIOUS INJURY OR PROPERTY DAMAGE TO YOU OR THOSE AROUND YOU.



While this firearm is capable of firing “Plus-P” (+P) ammunition in the appropriate caliber for the firearm, steady use of “Plus-P” (+P) ammunition may affect the wear characteristics, shorten the life and endurance of your firearm, and necessitate more frequent maintenance and replacement of parts.

When the firearm leaves the factory, its metal parts are protected by a coat of very adherent oil. This coating, especially inside of the barrel, must be removed before using the firearm. The oil on the outside surfaces should also be removed when the packing box has been open because the oil is very sticky and it easily retains dust and other solid impurities from the air.

The firearm is designed to fire semi-automatically. The trigger must be fully released before the firearm will be ready to fire again.



WARNING

Because this firearm can be used as a single shot, it will fire whether or not a magazine is in the firearm if a cartridge is chambered.

FIREARM WILL FIRE WITH MAGAZINE OUT.





GENERAL INFORMATION AND MECHANICAL CHARACTERISTICS (CONT'D)

The firearm shown in Fig. 1a and 1b are the MC2c® and MC2sc™ pistol model(s) that come equipped with a manual safety. There are versions of the MC2c® and MC2sc™ that do not come equipped with a manual safety and will differ from these figures (See the Safety Operation section of this owner's manual).



**Fig. 1a
(MC2sc™)**



**Fig. 1b
(MC2c®)**



Fig. 2



Read and understand this manual and its safety warnings before loading, unloading, firing or otherwise using or handling the firearm.





LOADED CHAMBER VIEW PORT



ALWAYS TREAT EVERY FIREARM AS THOUGH IT IS LOADED AND ALWAYS KEEP THE MUZZLE POINTED IN A SAFE DIRECTION. NEVER RELY ON THE LOADED CHAMBER VIEW PORT OR MEMORY TO DETERMINE WHETHER OR NOT A FIREARM IS LOADED. THE COLOR OF THE CARTRIDGE, LIGHTING CONDITIONS, CLEANLINESS OF THE FIREARM CAN EFFECT THE VISIBILITY OF A CARTRIDGE THROUGH THE VIEW PORT. A LOADED CHAMBER VIEW PORT MAY HELP IDENTIFY IF THERE IS A ROUND IN THE CHAMBER. TO CONFIRM THAT A FIREARM IS UNLOADED YOU MUST SET THE MANUAL SAFETY TO ON (IF SO EQUIPPED), REMOVE THE MAGAZINE AND VISUALLY AND PHYSICALLY CHECK THE CHAMBER, MAGAZINE WELL AND MAGAZINE.

Some models come equipped with a loaded chamber view port. The loaded chamber view port is an opening at the rear of the barrel hood (Fig. 3). By looking into this view port, while pointing the pistol in a safe direction, you may see the presence of a cartridge in the chamber. If a round is in the chamber you may see the rim of the cartridge through the view port.

LOADED CHAMBER VIEW PORT



Fig. 3





SAFETY OPERATION

The manual safety model comes equipped with a manual safety and two passive safeties: a bladed trigger and firing pin safety block. The standard model does not come equipped with a manual safety.



Remember, a firearm's manual safety is a mechanical device which can never replace safe firearm handling practices.



Never rely on any mechanical mechanism or safety device to prevent the dangers of careless handling or pointing a firearm in an unsafe direction.

The manual safety (if so equipped) is located on the frame, behind the trigger and must be manually moved to the desired position by the shooter.



Fig. 4



Fig. 5



THESE INSTRUCTIONS DESCRIBE THE MANUAL SAFETY SET UP FROM THE FACTORY FOR RIGHT HANDED USE. IF THE MANUAL SAFETY IS REVERSED, THE MANUAL SAFETY WILL OPERATE IN THE REVERSE DIRECTION AS DESCRIBED BELOW (TO SET UP THE MANUAL SAFETY FOR LEFT HANDED USE, SEE REVERSING THE MANUAL SAFETY SECTION OF THIS OWNER'S MANUAL).

To set the manual safety to the "ON" (SAFE) position, the manual safety must be pushed from the left side so that it moves fully to the right (Fig. 4). The manual safety must always be pushed fully to the right until it moves no further to be set to the "ON" (SAFE) position. The frame will now cover the red line. The red line is a training aid used only to show the direction of the "ON" (SAFE) position and should not be used as an indicator that the manual safety is "ON" or "OFF." Pushing the manual safety fully to the left will set the safety to the "OFF" (FIRE) position (Fig. 5). The red line will now be visible. This describes the manual safety set up from the factory for right handed use. If the manual safety is reversed, the manual safety will operate in the reverse direction as described above.



Keep your finger off the trigger and outside of the trigger guard until you are aiming at the intended target and have decided to fire. The manual safety (if so equipped) should remain fully set to the "ON" (SAFE) position and the firearm unloaded at all times until you are in a place where it is safe to shoot.





Placing the safety in an intermediate position between the “ON” and “OFF” position can result in the user thinking the firearm is in a **SAFE** or **FIRE** position when it is not. Pulling the trigger with the safety in an intermediate position may cause the firearm to fire. Therefore, always move the safety fully to its intended position, “ON” or “OFF”, and then check to be sure it is where you want it to be. Never attempt to fire the firearm with the safety only partially engaged, as the firearm may discharge and could result in death, serious injury or property damage.

NOTE: Ensure the trigger is set in the forward position before engaging the manual safety. If it is not, push the trigger forward until it is set in the forward position (Fig. 6).

BLADED TRIGGER

Both the standard and manual safety model come equipped with a trigger that contains a trigger blade which must be fully depressed along with the trigger to fire the firearm (Fig. 6). The trigger blade in the forward position blocks the trigger from moving rearward. If the trigger blade is not fully depressed, the trigger will not move rearward and allow the firearm to fire.

**TRIGGER SHOWN
SET IN THE FORWARD
POSITION**



Fig. 6



Remember, a firearm's safety is a mechanical device which can never replace safe firearm handling practices.



Never rely on any mechanical mechanism or safety device to prevent the dangers of careless handling or pointing a firearm in an unsafe direction.



Keep your finger off the trigger and outside of the trigger guard until you are aiming at the intended target and have decided to fire. Ensure the manual safety (if so equipped) is fully set to the “ON” (**SAFE**) position and the firearm unloaded at all times until you are in a place where it is safe to shoot.



OPENING THE ACTION



Ensure the manual safety (if so equipped) is fully set to the “ON” (SAFE) position. For all models, remove the magazine and visually and physically check the chamber, magazine well and magazine to be sure the firearm is unloaded. Keep the muzzle pointed in a safe direction while opening the action.

Hold the grip with your firing hand, keep your finger off the trigger and outside the trigger guard, grasp the rear of the slide on the serrations with your other hand and pull the slide fully rearward (“retracted”) (Fig. 7). While holding the slide rearward, apply upward pressure with your thumb to engage the slide stop lever and slowly release the slide from the rearward position until it locks in the open position (Fig. 8).



Fig. 7



Fig. 8



When opening the action is necessary as instructed in this manual, the slide should always be pulled fully rearward (“retracted”) by placing your fingers on the slide serrations and pulling. Always keep your fingers out of the trigger guard and away from the trigger. Never put any part of your hand or body over or in front of the muzzle while opening the action.



Except when the slide is locked in the open position, (fully rearward or “retracted”) and you are checking to ensure that the chamber is empty, never place your fingers in the ejection port because they could be injured by the movement of the slide.





REMOVING AND INSTALLING THE MAGAZINE



WARNING

Because this firearm can be used as a single shot, it will fire whether or not a magazine is in the firearm if a cartridge is chambered.

FIREARM WILL FIRE WITH MAGAZINE OUT.



Removal of the magazine will not unload the firearm! After you remove the magazine **always** visually and physically inspect the chamber to ensure the firearm is completely unloaded!



Ensure the manual safety (if so equipped) is fully set to the “ON” (SAFE) position. For all models, remove the magazine and visually and physically check the chamber, magazine well and magazine to be sure the firearm is unloaded. Keep the muzzle pointed in a safe direction while opening the action.

To Remove the Magazine

The magazine can be removed with the action in the open or closed position. Remove the magazine by pressing on the magazine release (Fig. 9). Familiarize yourself with the firearm by installing and removing an **unloaded** magazine and by learning to keep the action in the **open** position.



Fig. 9

To Install the Magazine

Insert the **unloaded** magazine into the magazine well, push the magazine into place until an audible click is heard indicating that it is retained (Fig. 10). Pull on the magazine to make sure the magazine is firmly seated (Fig. 11).



Fig. 10



Fig. 11





LOADING THE FIREARM



Before loading, ensure the manual safety (if so equipped) is fully set to the “ON” (SAFE) position.



Before loading, visually and physically inspect the chamber and barrel for any obstruction, excessive oil or grease (the chamber is the rear portion of the barrel which will contain the cartridge). Obstructions of any kind could cause death, serious injury or property damage to you or those around you.



During loading never allow fingers or any objects to contact the trigger. Keep the muzzle pointed in a safe direction at all times.



Do not load firearm until ready for use! Unload firearm when shooting has been completed! The manual safety (if so equipped) should always be fully set to the “ON” (SAFE) position whether the firearm is loaded or not.



Check to be certain that the correct ammunition has been selected for use. Ensure it is the same caliber and type of cartridge as designated on the top of the barrel.



Always inspect your ammunition before using it. Never use dirty, corroded or damaged ammunition. A cartridge failure could cause death, serious injury or property damage to you or those around you.



Use only new commercially manufactured ammunition which is in strict accordance with the standards of the Sporting Arms and Ammunition Manufacturers’ Institute (SAAMI). If you are uncertain, contact your ammunition supplier for verification.



Do not use “Plus-P-Plus” (+P+) ammunition in this firearm. Pressures generated could exceed SAAMI maximums and could cause death, serious injury or property damage to you or those around you.



This firearm is capable of firing a chambered cartridge with the magazine empty, without the magazine inserted, or if the magazine is dislodged from its seat.



Always chamber cartridges from the magazine only. Keep your finger off the trigger and outside of the trigger guard until prepared to fire. Failure to do so could result in death, serious injury, or property damage to you or those around you.



WARNING: This product can expose you to chemicals, including lead, which are known to the State of California to cause cancer and birth defects or other reproductive harm. For more information go to www.P65Warnings.ca.gov.





LOADING THE MAGAZINE

To load the magazine, remove the magazine by pressing the magazine release (Fig. 9, Refer to Removing and Installing the Magazine section of this owner's manual). Hold the magazine in one hand and insert one cartridge at a time (Fig. 12a), pressing against the magazine follower and pushing the cartridge fully rearwards until the magazine is full, or until the desired number of cartridges have been loaded. **Capacities of each magazine are stamped on the side of MC2c® and MC2sc™ steel magazines (Fig. 12b) Do not attempt to insert more cartridges than the magazine's designed capacity. Use only magazines intended for your respective model.**

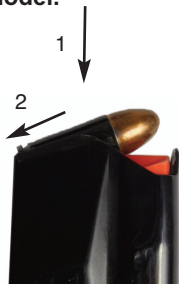

Fig. 12a



Fig. 12b

LOADING THE MAGAZINE INTO THE FIREARM



Do not use excessive force when inserting a loaded magazine into the firearm. Excessive force could cause the slide to move forward, chambering a round and making the firearm ready to fire.



The firearm is ready for firing as soon as the slide is pulled fully rearward ("retracted") and then released and the manual safety (if so equipped) is fully set to the "OFF" (FIRE) position.



To minimize the risk of unintended firing, leave the chamber empty and the manual safety (if so equipped) fully set to the "ON" (SAFE) position until you are on target and have decided to fire. Keep the muzzle pointed in a safe direction at all times and your fingers and any other objects outside the trigger guard and away from the trigger.

Insert a loaded magazine into the firearm by sliding the magazine up into the magazine well until an audible click is heard indicating that it is retained (Fig. 10, Refer to Removing and Installing the Magazine section of this owner's manual). Pull on the magazine to make sure the magazine is firmly seated (Fig. 11, Refer to Removing and Installing the Magazine section of this owner's manual).

FIRING





Use of this product, including discharging firearms in poorly ventilated areas, cleaning firearms, or handling ammunition can result in exposure to chemicals, including lead, which are known to the state of California to cause serious physical injury, including cancer, birth defects or other reproductive harm. For more information, go to www.P65Warnings.ca.gov. Have adequate ventilation at all times and wash hands thoroughly after exposure.





 Always wear eye and ear protection when firing a firearm. Firing a firearm without proper ear protection can cause hearing loss. The use of eye protection during any type of shooting, disassembly, assembly and cleaning is important to protect your vision.

 When ready to fire be sure that the area behind the slide is clear, never place your thumb behind the slide. Do not hold the firearm close to your body, as the slide will move forcefully rearward when the firearm is fired.

 Except when the slide is locked in the open position, (fully rearward or “retracted”) and you are checking to ensure that the chamber is empty, never place your fingers in the ejection port because they could be injured by the movement of the slide.

 Be sure of your target and beyond. Make sure that your back stop is adequate to stop bullets prior to firing.

 Always ensure that barrel and action are clear of obstructions before firing. Firing a blocked firearm could cause death, serious injury, or property damage to you or those around you.

 If a bullet is in the bore or lodged in the barrel, do not attempt to shoot it out by using another cartridge, by blowing it out with a blank, or with a cartridge from which the bullet has been removed. Such actions can generate excessive pressure that could cause death, serious injury or property damage to you or those around you.

 When you pull the trigger you must expect the firearm to fire and you must take full responsibility for your actions.

After loading and inserting the magazine into the firearm as described in this manual, keeping the muzzle pointed in a safe direction, close the action by depressing the slide stop lever (Fig. 13). With the firearm pointed in a safe direction and held in the proper firing position, set the manual safety (if so equipped) fully to the “OFF” (FIRE) position (Fig. 5, Refer to Safety Operation section of this owner’s manual). Depressing the trigger blade and pulling the trigger fully rearward will fire the firearm.





Fig. 13

After the firearm is fired the action will cycle and automatically load the next cartridge. The trigger must be fully released before the firearm will be ready to fire again.

 After firing, the empty cartridge will be automatically ejected through the ejection port. Be sure all body parts and observers are clear of the path of ejection, as the empty cartridges are hot and are ejected with considerable force and could cause injury.





 This firearm automatically feeds the next live cartridge from the magazine into the chamber each time the firearm is fired, until all cartridges in the magazine are fired. You should be aware that no mechanical force on the part of the user is needed in this process and you should be alert to the fact that the chamber is loaded and the firearm is capable of firing again if the trigger is pulled.

 This firearm is designed so that when all cartridges have been fired, the slide will automatically lock rearward in the open position. You should never use this feature as a guide for determining if the firearm is empty! Always visually and physically inspect the chamber, magazine well and magazine for the presence of ammunition.

 Should any cartridge fail to fire, keep the muzzle pointed in a safe direction for at least thirty (30) seconds in case the cartridge is a “hangfire” (delayed firing of the cartridge after being struck by the firing pin.) Then, remove the magazine (as it may still have loaded cartridges in it), pull the slide fully rearward, lock the action in the open position and extract and eject the misfired cartridge. Segregate the misfired cartridge from other ammunition. Do not attempt to refire a misfired cartridge. If the indent from the firing pin is light or absent, contact a qualified gunsmith or the Product Service Center.

 If at any time during firing, the sound of any cartridge is noticeably louder or softer than previous cartridges fired, STOP! Do not load or fire additional cartridges. Keep the muzzle pointed in a safe direction, remove the magazine (as it may still have loaded cartridges in it) and, while keeping the ejection port and magazine well opening of the firearm turned away from your face (to protect your eyes in the event a defective cartridge explodes), pull the slide fully rearward and lock the action open. Visually and physically verify that the chamber is empty. Move the manual safety (if so equipped) fully to the “ON” (SAFE) position. After unloading, inspect your firearm for possible damage or obstructions in the chamber or bore.

 Some brands of ammunition may cause difficulty in extracting spent cartridge cases from the chamber. If this situation occurs, thoroughly clean the chamber with solvent (refer to Cleaning And Lubrication section of this owner’s manual). If this condition persists, we recommend you change to another brand of ammunition.

 Use only new commercially manufactured ammunition which are in strict accordance with the standards of the Sporting Arms and Ammunition Manufacturers’ Institute (SAAMI). If you are uncertain, contact your ammunition supplier for verification.

 All auto-loading firearms may occasionally experience a malfunction (jam) related to the feeding of ammunition. If a cartridge jams, do not attempt to force it into the chamber. Carefully remove it by following steps 1-7 in the To Clear A Malfunction (“Jam”) section of this owner’s manual. Most malfunctions are caused by improper ammunition, an improper grip on the firearm when firing (limp wristing), improper lubrication, or a damaged magazine. To help minimize the chance of malfunctions (jams), regularly perform cleaning/preventative maintenance on your firearm pursuant to the instructions in this manual. If you experienced a malfunction (jam) while using a



new brand, type or lot of ammunition, try firing another type of ammunition to determine whether the ammunition was the source of the malfunction (jam).

TO CLEAR A MALFUNCTION (“JAM”)

1. Always keep the muzzle pointed in a safe direction. Keep your finger off the trigger and outside the trigger guard. Ensure the manual safety (if so equipped) is fully set to the **“ON” (SAFE)** position, and that you are wearing eye and ear protection.
2. Remove the magazine (Refer to Removing and Installing the Magazine section of this owner’s manual). If the magazine cannot be removed, proceed to step 6.
3. Lock the action in the open position (Refer to Opening the Action section of this owner’s manual).
4. Visually and physically inspect the chamber, magazine well and magazine to be certain the firearm is unloaded, and that the cartridge that was stuck has been ejected during this process. If the cartridge has ejected and there is no jam, then properly clean the firearm as instructed in this manual, and try different ammunition. You may now resume normal operation. If you still experience a jam, contact a qualified gunsmith or the Product Service Center.
5. If a stuck cartridge is in the chamber and does not eject after the above steps, then do not attempt to close the action. Remove the striker assembly (refer to the Disassembly section of this owner’s manual), and contact a qualified gunsmith so that the gunsmith may remove the cartridge and verify there is no damage to the firearm.
6. If you were not able to remove the magazine as instructed in step 2 above, then lock the action in the open position (refer to Opening the Action section of this owner’s manual) and attempt to remove the magazine (refer to Removing and Installing the Magazine section of this owner’s manual). If the magazine is now able to be removed, then proceed with steps 4 and 5 outlined above.
7. If the magazine still cannot be removed after performing step 6 above, then do not attempt to close the action. Remove the striker assembly (refer to the Disassembly section of this owner’s manual), and contact a qualified gunsmith so that the gunsmith may provide further assistance and verify there is no damage to the firearm.



Never pull the trigger if the slide does not fully close to prevent a possible out of battery firing. If this happens, unload the firearm (refer to Unloading the Firearm section of this owner’s manual). Examine the round that was in the chamber and check the chamber to ensure that there are no obstructions or debris in it.



Never force a jammed action. This could cause a round to explode resulting in death, serious injury or property damage to you or those around you.



Do not use a metal tool to attempt to remove an unfired cartridge because it could ignite the primer and fire or rupture sending fragments out of the ejection port with sufficient force that could cause death, serious injury or property damage to you or those around you.

UNLOADING THE FIREARM



Set the manual safety (if so equipped) fully to the “**ON**” (**SAFE**) position. During unloading, never allow fingers or any other object to contact the trigger. **KEEP THE MUZZLE POINTED IN A SAFE DIRECTION AT ALL TIMES.**



WARNING: This product can expose you to chemicals, including lead, which are known to the State of California to cause cancer and birth defects or other reproductive harm. For more information go to www.P65Warnings.ca.gov.

Remove the magazine by pressing on the magazine release (Fig. 9, Refer to Removing and Installing The Magazine section of this owner’s manual). Hold the grip with your firing hand, and keeping your finger off the trigger and outside the trigger guard, grasp the rear of the slide on the serrations with your other hand and pull the slide fully rearward (Fig. 7, Refer to Opening The Action section of this owner’s manual). While holding it rearward, apply upward pressure with your thumb to engage the slide stop lever and slowly release the slide from the rearward position until it locks in the open position (Fig. 8, Refer to Opening The Action section of this owner’s manual). This will extract a loaded cartridge from the chamber.



After unloading always visually and physically inspect the chamber, magazine well and magazine to make sure that all of the cartridges have been removed.

UNLOADING THE MAGAZINE

Hold the magazine in one hand bottom down and front end forward. Push the cartridge forward and allow the nose of the cartridge to rise slightly upward until it is released from the magazine. Repeat until magazine is unloaded.

DISASSEMBLY



Keep the muzzle pointed in a safe direction at all times. Lock the action open and set the manual safety (if so equipped) fully to the “**ON**” (**SAFE**) position. Remove the magazine and visually and physically inspect the chamber, magazine well and magazine to be certain the firearm is unloaded before disassembling the firearm (refer to the Unloading The Firearm section of this manual). Wear eye protection during disassembly and cleaning.

Once the firearm is unloaded, lock open the action (refer to Opening the Action section of this owner’s manual). Push in the slide cover plate button (the patent pending slide cover plate design is used under license from Strike Industries) and slide the slide cover plate out of the slide (Fig. 14).

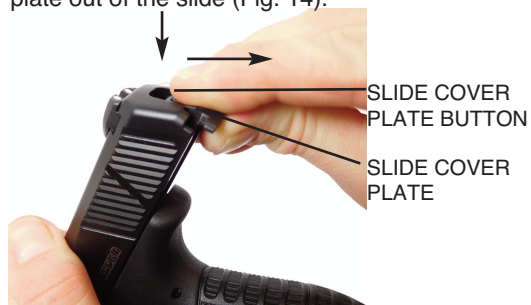

Fig. 14



Close the action by grasping the rear of the slide at the serrations pulling the slide fully rearward and then releasing it gently. This will allow the slide to push out the striker assembly. You can then remove the striker assembly, push the slide fully forward towards the muzzle end and slide it off the frame (Fig. 15).



Fig. 15

Holding the slide in one hand, push the recoil spring assembly toward the muzzle end of the slide, pull it up and remove it from the slide (Fig. 16a and 16b).

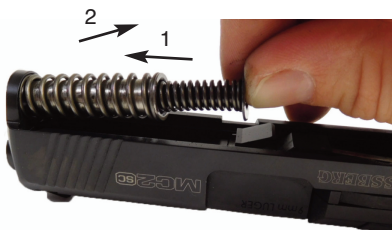

Fig. 16a



Fig. 16b

Holding the barrel by the barrel locking cams, lift it and push it toward the muzzle end of the slide, pull it up and remove it from the slide (Fig. 17).



Fig. 17



Further disassembly should only be performed by a qualified gunsmith or the Product Service Center. Improper disassembly or reassembly, alterations, modifications and/or repairs by a party other than Mossberg could compromise the safety or performance of your firearm, and could result in death, serious injury, or property damage to you or others and will void your warranty.





CLEANING AND LUBRICATION

With proper maintenance and care, your firearm will provide you with years of dependable service. Your firearm should be inspected and cleaned periodically to ensure that it remains in good condition. Clean and lubricate your firearm as soon as possible after use. This is especially important if your firearm has been exposed to moisture. For maximum performance and continued satisfaction with your firearm, periodic cleaning and lubrication are essential. Wear eye protection during cleaning.

Use the instructions and equipment provided in a quality firearm cleaning kit.



Always be sure that the firearm is unloaded (refer to the Unloading section of this owner's manual) by visually and physically checking the chamber, magazine well and magazine before cleaning your firearm. Be sure that the manual safety (if so equipped) is fully set to the "ON" (SAFE) position. Wear eye protection during cleaning and assembly to protect your eyes from oil splatter and spring loaded components.



Always make sure that no ammunition is located in the area where you clean your firearm. Cleaner-lubricant-preservative can affect the primer and powder in ammunition and cause it to malfunction. This could result in a bullet being pushed into the barrel of your pistol and getting stuck. Firing another round with a bullet stuck in the barrel could cause the barrel to burst and result in death, serious injury, or property damage to you or those around you.



WARNING: This product can expose you to chemicals, including lead, which are known to the State of California to cause cancer and birth defects or other reproductive harm. For more information go to www.P65Warnings.ca.gov.

All metal parts should be cleaned with an appropriate firearm cleaning solvent and lightly lubricated with firearm oil. Over lubrication should be avoided. Use only lubricants specifically designed for firearms. Avoid the use of abrasives which may damage the metal finish.

If the firearm is to be stored for a long period of time it should be thoroughly cleaned and oiled. Do not plug the barrel or store in a fabric lined case that will absorb lubricant from the firearm.

To clean and lubricate your firearm, first disassemble it (refer to the Disassembly section of this owner's manual).

THE BARREL

Using a cleaning patch and cleaning rod, wet the bore and chamber with cleaning solvent. Use a bore brush and a chamber brush to remove powder residue and fouling from the bore and chamber. Follow with dry cleaning patches until the patch remains clean.



Lightly coat a cleaning patch with oil or cleaning solvent and wipe the outside of the barrel hood and lugs (Fig. 18). If the firearm is to be stored, pass a lightly oiled patch through the bore to provide a protective coating.

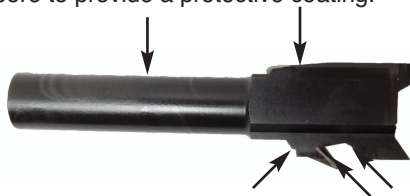

Fig. 18



Make sure the barrel is free of obstructions and excessive lubricant after cleaning. Be sure not to leave cleaning patches, excessive oil, or grease in the bore as they can create dangerous obstructions. Obstructions of any kind can cause damage to the firearm and could cause death, serious injury or property damage to you or those around you.



The recoil spring assembly can be cleaned using a nylon bristle brush. Lubricate with a lightly oiled patch.

THE SLIDE

Using a nylon bristle brush with cleaning solvent, thoroughly brush the slide rail cuts in the slide (Fig. 19b). Wipe the slide rail cuts with a dry cleaning patch until the patch remains clean.

Using a nylon bristle brush with cleaning solvent, brush the breech face and the area under the extractor claw. Wipe the breech face and the area under the extractor claw with a dry cleaning patch until the patch remains clean.

Wipe any other exposed areas of the slide to remove any dirt or debris using cleaning solvent and a cleaning patch or soft bristle brush. Lightly oil a cleaning patch and wipe down the exterior surfaces of the slide.

Once cleaned, lubricate inside the top of the slide in front of the ejection port where the barrel hood rubs against the slide, the opening that the barrel slides through at the muzzle end of the slide (Fig. 19a) and spread a drop of oil along the entire length of each slide rail cut (Fig. 19b).

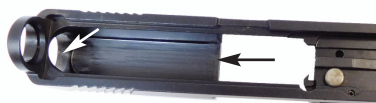

Fig. 19a



Fig. 19b



Do not put excessive lubricant or oil on the striker assembly or inside the striker channel. Make sure the magazine and breech face are wiped dry before reassembling your firearm. Leaving lubricant in these areas could cause contamination of ammunition and failure to fire.

THE FRAME

Wipe exposed areas of the frame with a clean, soft cloth. Use cotton swabs to clean hard to reach areas, paying special attention to the frame rails and slide stop lever.



Fig. 20

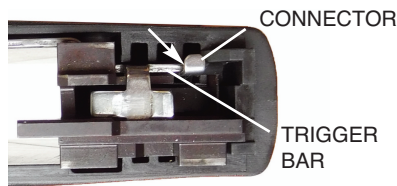

Fig. 21

Spread one drop of oil along each frame rail (Fig. 20). Place a drop of oil where the rear end of the trigger bar touches the connector at the right rear corner of the frame (Fig. 21).



Should you detect any cracks, fractures, chips, or excessive wear, do not use your firearm until you have contacted the Product Service Center or a qualified gunsmith. Using broken or worn parts could cause death, serious injury or property damage to you or those around you.

THE MAGAZINE

Wipe the outside of the magazine to remove any grit, dust or residue with a clean, soft cloth slightly dampened with cleaning solvent. Wipe off any excess cleaner or lubricant before using the magazine in your firearm.



There is no need to lubricate the magazine as it can cause dirt, oil and lubricant to build up inside the firearm causing malfunctions.

ASSEMBLY



Ensure there is no presence of ammunition while assembling your firearm. Be sure the chamber and magazine remain unloaded.

Holding the barrel by the barrel locking cams, insert the barrel into the slide by sliding it into the muzzle end of the slide, pushing down and pulling the barrel rearward until it rests in the ejection port (Fig. 22 and 23). Insert the recoil spring assembly in the orientation as shown below in Fig. 23. Ensure the back end of the recoil spring assembly rests in the notch on the barrel locking cams.



Fig. 22

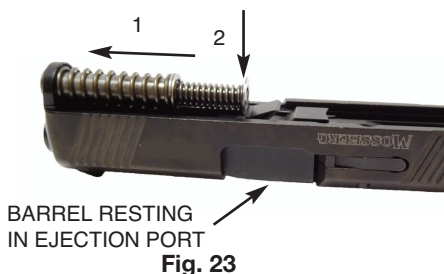

Fig. 23



NOTE: Ensure the trigger is set in the forward position before reassembling the slide onto the frame. If it is not, push the trigger forward until it is set in the forward position (Fig. 24).

Keeping your finger off the trigger and outside of the trigger guard, place the slide on top of the frame in front of the frame rails (Fig. 24). Push the slide towards the back of the frame while pushing the slide stop lever up with your thumb until the slide locks in the open position (Fig. 25).



Fig. 24



Fig. 25

Slide the striker assembly back into the slide orientated as shown (Fig. 26a and 26b). Pushing down on the slide cover plate button, push the striker assembly in towards the muzzle end of the slide with the slide cover plate and push the slide cover plate upward until it is fully seated in the slide (Fig. 27a and 27b).



Fig. 26a



Fig. 26b



Fig. 27a



Fig. 27b



Be sure to wear eye protection and check to ensure the firearm is functioning properly, (refer to the Function Testing section of this owner's manual) before using and/or firing live ammunition.





FUNCTION TESTING



AFTER PERFORMING ANY WORK ON YOUR FIREARM SUCH AS CLEANING, DISASSEMBLY, OR INSTALLATION OF AN ACCESSORY CHECK YOUR FIREARM FOR PROPER FUNCTIONING BEFORE USING AND/ OR FIRING ANY LIVE AMMUNITION:

- a. Set the manual safety (if so equipped) fully to the “**ON**” (**SAFE**) position and keep the muzzle pointed in a safe direction.
- b. Remove the magazine and pull the slide fully rearward to lock open the action, visually and physically check the chamber, magazine well and magazine to be certain the firearm is **unloaded**.



KEEP THE MUZZLE POINTED IN A SAFE DIRECTION AT ALL TIMES THROUGHOUT THE FOLLOWING STEPS! FAILURE TO DO SO COULD RESULT IN DEATH, SERIOUS INJURY OR PROPERTY DAMAGE TO YOU OR THOSE AROUND YOU IF THE FIREARM HAS NOT BEEN PROPERLY UNLOADED AND FIRES WHILE YOU ARE TESTING ITS FUNCTION!

Cycle the slide to reset the trigger to the forward position. Set the manual safety (if so equipped) fully to the “**ON**” (**SAFE**) position (Fig. 4, Refer to the Safety Operation section of this owner’s manual). With the muzzle of your firearm pointed in a safe direction, pull the trigger. The safety should prevent the trigger from moving rearward.

Set the manual safety (if so equipped) fully to the “**OFF**” (**FIRE**) position (Fig. 5, Refer to the Safety Operation section of this owner’s manual). With the muzzle of your firearm pointed in a safe direction, grasp the sides of the trigger without touching or depressing the trigger blade and attempt to pull the trigger to the rear. The trigger blade should prevent the trigger from moving fully rearward.

With the muzzle of your firearm pointed in a safe direction, depress the trigger blade and pull the trigger fully rearward. You should hear an audible click and feel the firing pin release. While continuing to hold the trigger to the rear pull the slide to the rear and release it, allowing it to snap forward. Now release the trigger. The trigger should reset to its forward position (Fig. 24, Refer to the Assembly section of this owner’s manual). Repeat the trigger reset test several times.

Insert an empty magazine into your firearm. Grasp the rear of the slide at the serrations and pull the slide fully rearward. The slide should lock open. Repeat the slide lock-open test using each of your EMPTY magazines.



IF YOUR FIREARM DOES NOT PERFORM AS DESCRIBED IN ANY OF THE ABOVE STEPS, CONTACT THE PRODUCT SERVICE CENTER IMMEDIATELY. DO NOT ATTEMPT TO LOAD OR USE THE FIREARM.



Firearms are complex mechanisms. Any modification, alteration, or improper fitting of parts may result in a dangerous malfunction, damage to the firearm, and could cause death, serious injury or property damage to you or those around you. The firearm’s owner must accept full responsibility for the correct reassembly and functioning of the firearm after any disassembly or replacement of parts.





SIGHT ADJUSTMENTS

This firearm is equipped with drift adjustable sights. The sights consist of a rear sight and a front sight blade (which are compatible with commercially available #8 style sights).



Ensure the manual safety (if so equipped) is fully set to the “**ON**” (**SAFE**) position and the firearm is unloaded. For all models, remove the magazine and visually and physically check the chamber, magazine well and magazine to be sure the firearm is **unloaded** before making any sight adjustments (Refer to the Unloading The Firearm section of this owner’s manual).



Care must be taken when making adjustments to drift adjustable sights. If you are unsure of your ability to adjust the sights, take your firearm to a gunsmith or certified armorer. Failure to properly adjust the sights on your firearm may result in damage to the sights or firearm.

Windage adjustments (left/right)

NOTE: The rear sight and front sight blade are adjustable for windage only. To adjust, use a sight pusher tool to prevent damage to the sights.

Move the rear sight in the direction you want the group to move on the target. If your group is to the left and you want to move it to the right, move the rear sight to the right. If your group is to the right and you want to move it to the left, move the rear sight to the left.

Lasers



Keep the muzzle pointed in a safe direction at all times. Lock the action open and set the manual safety (if so equipped) fully to the “**ON**” (**SAFE**) position. Remove the magazine and visually and physically inspect the chamber, magazine well and magazine to be certain the firearm is unloaded before installing or adjusting your laser.



Failure to follow any of the safety warnings listed when handling your firearm and/or the laser included with your firearm could cause death, serious injury or property damage to you or those around you.



Direct eye exposure can cause eye damage. Do not stare into the laser beam.



Do not shine the laser beam into another individuals eyes.



Do not look into the laser beam through binoculars or telescopes.



Do not point the laser beam at mirror-like surfaces.



Do not point the laser beam at another individual, animal, moving vehicle or aircraft.



Do not use the laser in environments containing an explosive atmosphere or in areas where gasoline, paints, solvents, or other flammable liquids are stored.



For firearms that come packed with a laser, refer to instructions included from laser manufacturer.





Laser warning label supplied must be installed on the firearm with the “laser aperture” arrow pointing to the laser diode lens.

Tritium Night Sights

Your firearm may come equipped with sights that contain a radioactive material for illumination during low light conditions or hours of darkness. The radiation source is hydrogen-3 which is commonly known as tritium.



Tritium is only hazardous if the vial is broken and ingested or inhaled by humans.



Do not eat, drink or smoke in the presence of a damaged tritium sight vial or handle any damaged sights if you have open cuts or abrasions.



Avoid flame in the presence of damaged tritium sights, burning tritium emits an extremely hazardous substance.



Disposal of tritium sights must be performed in a controlled manner. **DO NOT DISCARD TRITIUM SIGHTS IN THE TRASH!** If your sight becomes damaged or has broken, do not disassemble the sight! Follow these instructions:

Place damaged sights in a small zip lock bag and label it “Damaged Tritium Sight DO NOT OPEN”. Place the zip lock bag in a shipping envelope marked “NIGHT SIGHT FOR DISPOSAL” and send to:

Mossberg Product Service Center
1001 Industrial Blvd.
Eagle Pass, TX 78852

Reflex Sight Mounting

Some Mossberg pistols may be fitted with a machined slide to allow the direct mounting of micro red dot (reflex) sighting systems.



Keep the muzzle pointed in a safe direction at all times. Lock the action open and set the manual safety (if so equipped) fully to the “**ON**” (**SAFE**) position. Remove the magazine and visually and physically inspect the chamber, magazine well and magazine to be certain the firearm is unloaded before installing or mounting your sights.

Remove the slide (refer to the Disassembly section of this owner’s manual).

Using the 2mm allen key provided, remove the two screws retaining the optics cover plate (Fig. 28a). Be sure to keep the screws and the optics cover plate for future re-installation.

Following the optic manufacturer’s installation instructions, test fit the reflex sight in the milled area (Fig. 28b) on the pistol slide. Make sure the reflex sight is resting flat on the slide and positioned over the mounting holes.

Using two M4x0.7mm screws provided by the optic manufacturer, fasten the optic to the slide. Check to ensure that the screws are of the proper length and do not bottom out in the threaded holes prior to securing the optic. The screws may need to be shortened by filing or grinding in order to get a proper fit.



Check screw tightness on a regular basis and re-tighten to proper specifications if necessary. If an optical sight is not mounted on the slide, reinstall the optics cover plate using the 2mm allen key provided and tighten the original screws to 15 in/lbs.

Over-tightening may cause damage. Thread locker is optional. Medium blue strength Loctite® is recommended. Apply a very small amount to the screw threads only before assembling to ensure stability.

Reassemble the slide onto the frame (refer to the Assembly instructions in this owners manual).



After performing any adjustments, disassembly or reassembly on your firearm refer to the Function Testing section of this owner's manual. The firearm should be re-checked for proper functioning before using and/or firing live ammunition.



Fig. 28a

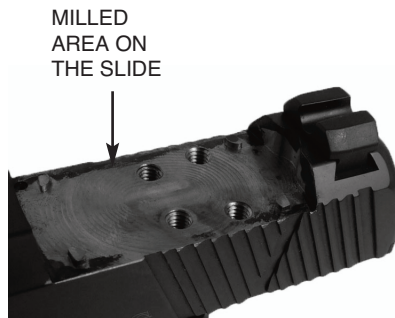

Fig. 28b



NOTE:
KEEP OPTICS COVER PLATE
AND SCREWS FOR FUTURE
RE-INSTALLATION





REVERSING THE MAGAZINE RELEASE

Your firearm features an extended magazine release that is reversible for right or left handed use. The firearm must be disassembled before the magazine release can be reversed (refer to the Disassembly section of this owner's manual).



Always wear eye protection during disassembly and reversing the magazine release to protect your eyes from spring loaded components.

While pressing against both sides of the magazine release to prevent it from moving, hold the frame so that you can see down into the magazine well. Use a small flat head screwdriver to push the magazine release spring towards the "U" shaped cut in the magazine release to release the spring tension on the magazine release (Fig. 29a and 29b).



Fig. 29a

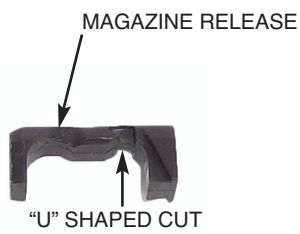
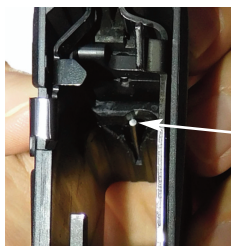

Fig. 29b

Remove the magazine release pulling it out of the frame from the outside. Reverse the magazine release and reinsert it into the opposite side of the frame from the outside.



ALLOW MAGAZINE RELEASE TO SLIP BENEATH THE SPRING.

Fig. 30

When the magazine release meets the magazine release spring, allow the magazine release to slip beneath the spring (Fig. 30). Use a small flat head screwdriver and push the spring back into the "U" shaped cut in the magazine release to re-engage the magazine release spring tension.

Insert an empty magazine into the frame and press the magazine release to confirm that it operates correctly. Repeat several times (Refer to the Function Testing section of this owner's manual).

To reassemble your firearm refer to the Assembly section of this owner's manual.



After performing any adjustments, disassembly or reassembly on your firearm refer to the Function Testing section of this owner's manual. The firearm should be re-checked for proper functioning before using and/or firing live ammunition.





REVERSING THE MANUAL SAFETY

The manual safety model comes equipped with a manual safety that is reversible for right or left handed use (refer to the Safety Operation section of this owner's manual). The firearm must be disassembled before the manual safety can be reversed (refer to the Disassembly section of this owner's manual).



Always wear eye protection during disassembly and reversing the manual safety to protect your eyes from spring loaded components.

Hold the frame so that you can see down into the magazine well. Using a paperclip push down on the safety plunger and spring (Fig. 31). Push the manual safety in until it audibly clicks out of place. Release the tension on the safety plunger and spring while ensuring they remain in the frame.



Fig. 31

Turn the manual safety over keeping the two detents on the bottom and slide it back into the frame (Fig. 32a). Lift up and over the plunger, using the manual safety to push the plunger down (Fig. 32b), push the manual safety in until it audibly clicks into place (Fig. 32c).



Fig. 32a

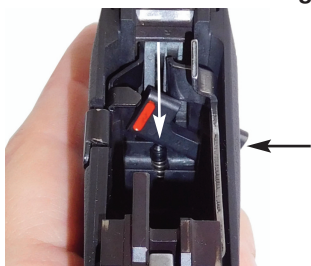

Fig. 32b



Fig. 32c



After performing any adjustments, disassembly or reassembly on your firearm refer to the Function Testing section of this owner's manual. The firearm should be re-checked for proper functioning before using and/or firing live ammunition.





STORAGE



Always store this firearm securely and unloaded. Failure to do so could result in an unintentional discharge.



Use the locking device supplied with the firearm for storage. The use of a locking device or cable lock is only one aspect of responsible firearms storage (see Cable Lock section of this owner's manual).



While locking devices are an important aid to security measures, they are not a substitute for safe firearm handling and proper storage. Mechanical and locking devices can fail and/or be bypassed with enough time, knowledge, determination and equipment.



Keep out of reach of children. Firearms should be stored unloaded in a location that is secure and inaccessible to children and any other unauthorized person, with ammunition locked securely in a different location.



Never act in an irresponsible manner or ignore any established rules of safety when using or storing firearms.

After unloading, cleaning and lubrication and function testing this firearm as instructed in this owner's manual, follow these instructions on storage to properly and securely store your firearm:

1. Select a safe and secure location for storage, one that conforms to the instructions and recommendations of this manual and all applicable laws, including but not limited to use of the cable lock provided with this firearm (see Cable Lock section of this owner's manual).
2. If possible, do not store the firearm in the factory-supplied case, or in a holster as moisture may collect and cause damage.
3. If you plan on storing the firearm for extended periods of time between uses, clean and lubricate the firearm per instructions in this manual every six months (see Cleaning and Lubrication section of this owner's manual).





CABLE LOCK



Before installing the cable lock, ensure the manual safety (if so equipped) is fully set to the “**ON**” (**SAFE**) position. For all models, remove the magazine and visually and physically check the chamber, magazine well and magazine to be sure the firearm is **unloaded**. Keep the muzzle pointed in a safe direction while opening the action.



Do not close the action with the cable lock installed. This will result in damage to your cable lock and firearm.



Store your cable lock keys in a separate location.

To Install the cable lock:

1. Ensure the action remains locked in the open position to install your cable lock.
2. Unlock the cable lock with the key provided, leave the key in the lock body.
3. Pass the free end of the cable through the ejection port and down through the magazine well.
4. Align the free end of the cable with the open hole on the lock body. Press and hold firmly in place.
5. Turn the key counter clockwise until locked. Remove the key.
6. Tug on lock body to be sure the cable lock is secure. If not locked, reinsert the key and repeat steps 4 and 5.
7. To unlock the cable lock, insert the key into the lock body. Turn clockwise and pull on the lock body until the cable releases.



**CORRECT INSTALLATION
OF CABLE LOCK**

Fig. 33



Ensure the cable lock is installed correctly as shown in Fig. 33. Improper installation of the cable lock or storage of your firearm could cause death, serious injury or property damage to you or those around you.



SERVICE INSTRUCTIONS

Should your firearm, or any component of your firearm require service, ship your entire firearm (please do not send components only), via your chosen carrier, postage paid (we do not accept C.O.D. shipments), following these instructions:

Repairs in the U.S.

For repair service, please start the process by filling out our Service Request Form online at <http://www.mossberg.com/service> prior to shipping your firearm.



- **Make absolutely certain your firearm is unloaded.**
- **Do not send ammunition with your firearm.**
- Remove all accessories from your firearm such as scopes, slings, mounts, etc.
- Ship your firearm in a suitable container, packaging it securely to prevent parts from shifting and/or damage during shipping.
- Include a note with a clear description of the service you wish us to perform, your complete return shipping address (no P.O. boxes please), your daytime telephone number and your e-mail address (if available).
- It is advisable to place your correspondence inside your shipping container when shipping.

SHIPPING ADDRESS

Mossberg Product Service Center
1001 Industrial Blvd.
Eagle Pass, TX 78852

IMPORTANT NOTICE:

Do not attempt to ship a firearm via US Postal Service. Firearms must be returned via UPS or Fed Ex next day delivery, adult signature required.

If you have any service related questions, please contact the Product Service Center at (800) 363-3555 or service@mossberg.com

TO ORDER PARTS

To order parts from the Product Service Center, you can phone, email, or mail your order to one of the below numbers/addresses.

Phone Number: (800) 363-3555
E-mail Address: service@mossberg.com
Mailing Address: Mossberg Product Service Center
1001 Industrial Blvd.
Eagle Pass, TX 78852
Attn: Order Department

Please provide your name, address, city, state, zip, your daytime phone number and e-mail (if available). The Product Service Center will need the Model #, Serial #, Gauge/Caliber, Finish, Item #, and Part Name. There is a \$7.50 (U.S.) minimum parts order charge. Most major credit cards, money orders, and bank drafts are accepted.

Service outside of the U.S.A.

For Mossberg firearm parts and service requirements outside of the United States, customers are requested to contact the closest Mossberg stocking dealer/distributor.



MOSSBERG® WARRANTY
MC2c® COMPACT PISTOL & MC2sc™ SUB-COMPACT PISTOL
ONE (1) YEAR LIMITED WARRANTY

Limited Warranty: O.F. Mossberg & Sons, Inc. ("Mossberg") warrants to you, the original retail purchaser of a new MC2c® Compact Pistol or MC2sc™ Sub-Compact Pistol (the "Mossberg firearm"), that the Mossberg firearm will be free of defects in material or manufacture for a period of one (1) year from the date of your purchase of the new Mossberg firearm (the "Warranty Period") in the United States or Canada. This is the only express warranty on the Mossberg firearm.

MOSSBERG MAKES NO OTHER WARRANTIES OF ANY KIND OR CONDITIONS, INCLUDING, BUT NOT LIMITED TO ANY IMPLIED WARRANTY OF MERCHANTABILITY OR FITNESS FOR A PARTICULAR PURPOSE.

THE IMPLIED WARRANTIES OF MERCHANTABILITY AND FITNESS FOR A PARTICULAR PURPOSE, AND ALL OTHER WARRANTIES NOT EXPRESSLY MADE HEREIN ARE EXPRESSLY DISCLAIMED. All disclaimers and limitations of liability shall still apply even if the limited remedy of repair or replacement fails of its essential purpose. There are no warranties which extend beyond the description on the face hereof. Any action against Mossberg and/or any Mossberg affiliates based on an alleged breach of this limited warranty must be brought within one (1) year of the claimed breach.

This Limited Warranty gives you specific legal rights, and you may have other rights that vary from State to State.

Purchaser's Remedy: During the Warranty Period, Mossberg will, at its sole option and discretion, (1) repair the Mossberg firearm or any part thereof that, upon examination and testing by Mossberg, does not conform to the Limited Warranty without charge to you for parts or labor, or (2) replace the Mossberg firearm with a new or similar model. THIS REMEDY SHALL BE YOUR EXCLUSIVE AND SOLE REMEDY FOR ANY BREACH OF WARRANTY. MOSSBERG SHALL NOT BE RESPONSIBLE FOR ANY OTHER EXPENSES, LOSSES OR INCONVENIENCE THAT YOU MAY SUSTAIN AS A RESULT OF THE PURCHASE, USE, MALFUNCTION OR DEFECTIVE CONDITION OF THE MOSSBERG FIREARM. Mossberg reserves the right to inspect, examine and/or test the Mossberg firearm to assess any claim made under the Limited Warranty.

EXCLUSIONS: THIS WARRANTY DOES NOT COVER THE SURFACE FINISH OF ANY MATERIAL, THE COSMETIC APPEARANCE OF THE MOSSBERG FIREARM OR ANY DAMAGE CAUSED BY:

- (1) NORMAL WEAR AND TEAR;
- (2) FAILURE TO PERFORM PROPER CARE AND MAINTENANCE;
- (3) ACCIDENTS, ABUSE OR NEGLIGENCE;
- (4) BARREL OR BORE OBSTRUCTIONS;
- (5) FAILURE TO FOLLOW THE INSTRUCTIONS AND WARNINGS THAT ACCOMPANY THE MOSSBERG FIREARM; OR
- (6) THE USE OF DEFECTIVE, NON-SAAMI STANDARD, REMANUFACTURED, HAND-LOADED, AND/OR RELOADED AMMUNITION.
- (7) THE USE OF INCORRECT AMMUNITION, EX. WRONG CALIBER OR PLUS-P-PLUS (+P+).
- (8) DISASSEMBLY BEYOND THE INSTRUCTIONS OF THIS MANUAL;
- (9) CRIMINAL, NEGLIGENT OR IMPROPER USE;
- (10) OTHER FACTORS BEYOND MOSSBERG'S CONTROL.

IN ADDITION, ANY UNAUTHORIZED REPAIRS, ALTERATIONS OR MODIFICATIONS TO THE MOSSBERG FIREARM WILL AUTOMATICALLY VOID THE LIMITED WARRANTY.

(CONTINUED ON NEXT PAGE)





LIMITATION OF DAMAGES: EXCEPT WHERE PROHIBITED BY LAW, MOSSBERG AND AFFILIATES, OFFICERS, DIRECTORS, SHAREHOLDERS, EMPLOYEES, OR AGENTS WILL NOT BE LIABLE FOR ANY LOSS OR DAMAGE WHATSOEVER ARISING FROM THE USE OF THIS MOSSBERG FIREARM, WHETHER DIRECT, INDIRECT, SPECIAL, INCIDENTAL, CONSEQUENTIAL OR PUNITIVE, REGARDLESS OF THE LEGAL THEORY ASSERTED, INCLUDING CONTRACT, WARRANTY, NEGLIGENCE, OR STRICT LIABILITY. SOME JURISDICTIONS DO NOT ALLOW LIMITATIONS ON HOW LONG AN IMPLIED WARRANTY LASTS, OR THE EXCLUSION OF INCIDENTAL OR CONSEQUENTIAL DAMAGES, SO THE ABOVE LIMITATIONS MAY NOT APPLY TO YOU.

Warranty Service: To obtain service under this Limited Warranty, you must follow the instructions found in the "Service Instructions" section of the Owner's Manual and return the Mossberg firearm to the authorized Product Service Center. You are responsible for all shipping costs to the Product Service Center. Mossberg will not accept COD shipments of any Mossberg firearm for service. After repair or replacement under warranty, the Mossberg firearm or a similar model will be returned to you, return postage paid by Mossberg. If we replace the Mossberg firearm, we will keep the firearm that you returned to Mossberg, and you hereby relinquish any and all rights in such returned firearm.

Modification of Warranty: No agent, representative, distributor, or authorized dealer of Mossberg firearms has any authority to modify the terms or conditions of the Limited Warranty in any way. The Limited Warranty may only be modified in writing by an authorized officer of Mossberg.

THIS LIMITED WARRANTY IS EFFECTIVE JANUARY 1, 2021.



EXPLODED VIEW PARTS LIST

MC2c[®], MC2sc[™]

FINAL ASSEMBLY		MANUAL SAFETY	STANDARD
ITEM	DESCRIPTION	QUANTITY	QUANTITY
**1	FRAME	1	0
**1	FRAME, STANDARD	0	1
2	MAGAZINE RELEASE SPRING	1	1
3	MAGAZINE RELEASE	1	1
*4	FIRING PIN SAFETY SPRING	2	1
*5	MANUAL SAFETY PLUNGER	1	0
*6	MANUAL SAFETY	1	0
7	TRIGGER ASSEMBLY	1	1
8	TRIGGER SPRING	1	1
9	SLIDE STOP SPRING	1	1
10	SLIDE STOP LEVER	1	1
11	LOCKING BLOCK	1	1
12	TRIGGER PIN	1	1
13	LIFTER SPRING	1	1
14	LIFT SPRING HOLDER	1	1
15	CONNECTOR	1	1
16	TRIGGER MECHANISM HOUSING	1	1
17	TRIGGER HOUSING PIN	1	1
18	FRONT SIGHT	1	1
19	REAR SIGHT	1	1
20	SLIDE	1	1
21	SAFETY PLUNGER	1	1
*22	EXTRACTOR TRAVEL LIMITER	1	1
23	EXTRACTOR SPRING	1	1
24	EXTRACTOR	1	1
25	EXTRACTOR PIVOT PIN	1	1
26	FIRING PIN	1	1
27	SPACER SLEEVE	1	1
28	FIRING PIN SPRING	1	1
29	SPRING CUP	2	2
30	SLIDE COVER PLATE	1	1
*31	OPTICS COVER PLATE	1	1
*32	OPTICS COVER PLATE SCREWS	2	2
33	BARREL	1	1
*34	RECOIL SPRING ASSEMBLY	1	1
<p>** ITEMS ON PARTS LIST ARE RESERVED FOR QUALIFIED GUNSMITHS OR THE AUTHORIZED PRODUCT SERVICE CENTER ONLY.</p> <p>* NOT INCLUDED IN ALL MODELS.</p>			

EXPLODED VIEW MC2c[®], MC2sc[™]

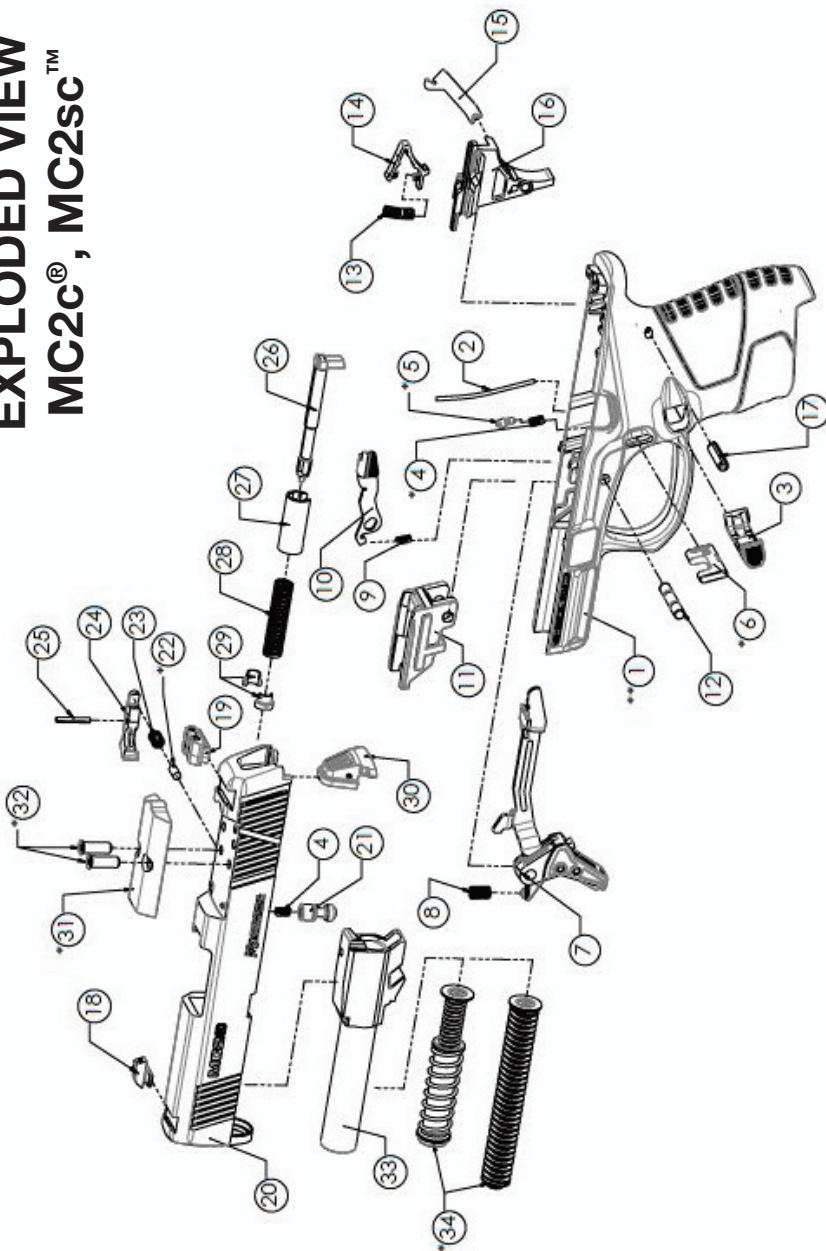

PARTS LIST AND EXPLODED VIEW, MAGAZINE

MAGAZINE ASSEMBLY PARTS LIST	
ITEM	DESCRIPTION
1	MAGAZINE BODY
2	MAGAZINE BASE
3	MAGAZINE FOLLOWER
4	MAGAZINE SPRING
5	MAGAZINE LOCKING PLATE
*6	MAGAZINE SPACER SLEEVE
*USED TO ADAPT MC2c® MAGAZINES TO MC2sc™ GRIPS	

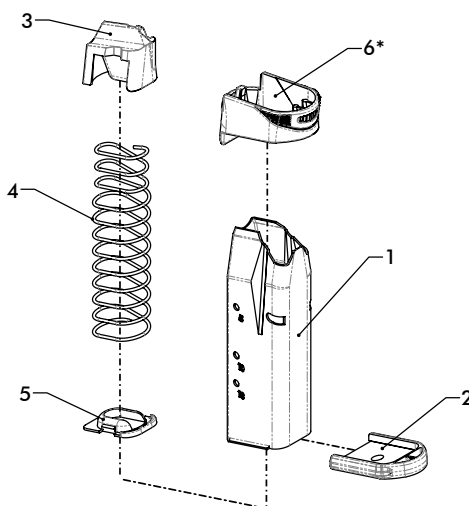

MAGAZINE COMPATIBILITY			
CAPACITY	DESCRIPTION	MC2c®	MC2sc™
11	METAL, DOUBLE STACK		STANDARD
10	METAL, DOUBLE STACK, REDUCED CAPACITY		OPTIONAL
13	METAL, DOUBLE STACK	STANDARD	COMPATIBLE
14	METAL, DOUBLE STACK	STANDARD	COMPATIBLE
15	METAL, DOUBLE STACK	STANDARD	COMPATIBLE
16	METAL, DOUBLE STACK	STANDARD	COMPATIBLE
10	METAL, DOUBLE STACK, REDUCED CAPACITY	OPTIONAL	COMPATIBLE



NOTES

A large, empty rectangular box with a thin black border, intended for handwritten notes.





NOTES





FIREARMS SAFETY DEPENDS ON YOU. MAKE NO MISTAKE ABOUT IT!

From the time an individual picks up a firearm, that individual shooter becomes a part of a system over which he or she has complete control. He or she is the only part of the system that can make a gun safe – or unsafe. Hunting and target shooting are among the safest of all sports. This booklet is intended to make them even safer – by re-emphasizing and reaffirming the basics of safe gun handling and storage and by reminding each individual shooter that he or she is the key to firearms safety. You can help meet this responsibility by enrolling in hunter safety or shooting safety courses. You must constantly stress safety when handling firearms, especially to children and non-shooters. Newcomers in particular must be closely supervised when handling firearms with which they may not be acquainted. Don't be timid when it comes to gun safety. If you observe anyone violating any safety precautions, you have an obligation to suggest safer handling practices, such as those in this booklet. Please read these rules carefully and follow the safety procedures outlined. Firearms safety is up to you. Make no mistake about it.

- 1. ALWAYS KEEP THE MUZZLE POINTED IN A SAFE DIRECTION**
- 2. FIREARMS SHOULD BE UNLOADED WHEN NOT ACTUALLY IN USE**
- 3. DON'T RELY ON YOUR GUN'S "SAFETY"**
- 4. BE SURE OF YOUR TARGET AND WHAT'S BEYOND IT**
- 5. USE CORRECT AMMUNITION**
- 6. IF YOUR GUN FAILS TO FIRE WHEN THE TRIGGER IS PULLED, HANDLE WITH CARE**
- 7. ALWAYS WEAR EYE AND EAR PROTECTION WHEN SHOOTING**
- 8. BE SURE THE BARREL IS CLEAR OF OBSTRUCTIONS BEFORE SHOOTING**
- 9. DO NOT ALTER OR MODIFY YOUR GUN, AND HAVE GUNS SERVICED REGULARLY**
- 10. LEARN THE MECHANICAL AND HANDLING CHARACTERISTICS OF THE FIREARM YOU ARE USING**

*Courtesy of
Sporting Arms and Ammunition Manufacturers' Institute, Inc.*

