

INSTRUCTION
MANUAL
FOR



RUGER®
SR1911® PISTOL



– Rugged, Reliable Firearms® –



**READ THE INSTRUCTIONS AND
WARNINGS IN THIS MANUAL CAREFULLY
BEFORE USING THIS FIREARM**

© 2020 Sturm, Ruger & Co., Inc.

This manual may not be reproduced in whole or in part without the express written permission of Sturm, Ruger & Co., Inc.

**For Service on This Model Please Call:
(336) 949-5200 (See p. 50)**

THIS INSTRUCTION MANUAL SHOULD ALWAYS ACCOMPANY THIS FIREARM AND BE TRANSFERRED WITH IT UPON CHANGE OF OWNERSHIP, OR WHEN THE FIREARM IS LOANED OR PRESENTED TO ANOTHER PERSON

Ruger.com

FF 5/2020 R14

State-By-State Warnings

Certain states require by law that their own specified warning notices in larger-than-normal type be conspicuously included by the manufacturer, distributor or retailer with firearms sold in that state. Sturm, Ruger & Co., Inc. sells its products in compliance with applicable laws and regulations. Because our products may be sold in these states, we include the following:

California:

WARNING

“Firearms must be handled responsibly and securely stored to prevent access by children and other unauthorized users. California has strict laws pertaining to firearms, and you may be fined or imprisoned if you fail to comply with them. Visit the Web site of the California Attorney General at <https://oag.ca.gov/firearms> for information on firearm laws applicable to you and how you can comply.

Prevent child access by always keeping guns locked away and unloaded when not in use. If you keep a loaded firearm where a child obtains and improperly uses it, you may be fined or sent to prison.”

ADVERTENCIA

“Las armas de fuego deben manipularse de manera responsable y segura para evitar el acceso de niños y otros usuarios no autorizados. California tiene leyes estrictas relacionadas con armas de fuego, y usted puede ser multado o encarcelado si no las cumple. Visite el sitio web del Procurador General de California en <https://oag.ca.gov/firearms> para obtener información sobre las leyes de armas de fuego que le son aplicables y cómo puede cumplirlas.

A los niños los atraen las armas de fuego y las pueden hacer funcionar. Ellos pueden causarse lesiones graves y la muerte. Evite que los niños tengan acceso a las armas de fuego guardándolas siempre con llave y descargadas cuando no las esté utilizando. Si usted tiene un arma de fuego cargada en un lugar en que un niño tiene acceso a ella y la usa indebidamente, le pueden dar una multa o enviarlo a la cárcel.”

Connecticut:

“UNLAWFUL STORAGE OF A LOADED FIREARM MAY RESULT IN IMPRISONMENT OR FINE.”

Florida:

“IT IS UNLAWFUL, AND PUNISHABLE BY IMPRISONMENT AND FINE, FOR ANY ADULT TO STORE OR LEAVE A FIREARM IN ANY PLACE WITHIN THE REACH OR EASY ACCESS OF A MINOR UNDER 18 YEARS OF AGE OR TO KNOWINGLY SELL OR OTHERWISE TRANSFER OWNERSHIP OR POSSESSION OF A FIREARM TO A MINOR OR A PERSON OF UNSOUND MIND.”

Maine:

“ENDANGERING THE WELFARE OF A CHILD IS A CRIME. IF YOU LEAVE A FIREARM AND AMMUNITION WITHIN EASY ACCESS OF A CHILD, YOU MAY BE SUBJECT TO FINE, IMPRISONMENT OR BOTH. KEEP FIREARMS AND AMMUNITION SEPARATE. KEEP FIREARMS AND AMMUNITION LOCKED UP. USE TRIGGER LOCKS.”

Maryland:

“WARNING: Children can operate firearms which may cause death or serious injury. It is a crime to store or leave a loaded firearm in any location where an individual knew or should have known that an unsupervised minor would gain access to the firearm. Store your firearm responsibly!”

Massachusetts:

“WARNING FROM THE MASSACHUSETTS ATTORNEY GENERAL: This handgun is not equipped with a device that fully blocks use by unauthorized users. More than 200,000 firearms like this one are stolen from their owners every year in the United States. In addition, there are more than a thousand suicides each year by younger children and teenagers who get access to firearms. Hundreds more die from accidental discharge. It is likely that many more children sustain serious wounds, or inflict such wounds accidentally on others. In order to limit the chance of such misuse, it is imperative that you keep this weapon locked in a secure place and take other steps necessary to limit the possibility of theft or accident. Failure to take reasonable preventive steps may result in innocent lives being lost, and in some circumstances may result in your liability for these deaths.”

“IT IS UNLAWFUL TO STORE OR KEEP A FIREARM, RIFLE, SHOTGUN OR MACHINE GUN IN ANY PLACE UNLESS THAT WEAPON IS EQUIPPED WITH A TAMPER-RESISTANT SAFETY DEVICE OR IS STORED OR KEPT IN A SECURELY LOCKED CONTAINER.”

New Jersey:

“IT IS A CRIMINAL OFFENSE TO LEAVE A LOADED FIREARM WITHIN EASY ACCESS OF A MINOR.”

New York City:

“THE USE OF A LOCKING DEVICE OR SAFETY LOCK IS ONLY ONE ASPECT OF RESPONSIBLE FIREARM STORAGE. FOR INCREASED SAFETY, FIREARMS SHOULD BE STORED UNLOADED AND LOCKED IN A LOCATION THAT IS BOTH SEPARATE FROM THEIR AMMUNITION AND INACCESSIBLE TO CHILDREN AND UNAUTHORIZED PERSONS.”

North Carolina:

“IT IS UNLAWFUL TO STORE OR LEAVE A FIREARM THAT CAN BE DISCHARGED IN A MANNER THAT A REASONABLE PERSON SHOULD KNOW IS ACCESSIBLE TO A MINOR.”

Texas:

“IT IS UNLAWFUL TO STORE, TRANSPORT, OR ABANDON AN UNSECURED FIREARM IN A PLACE WHERE CHILDREN ARE LIKELY TO BE AND CAN OBTAIN ACCESS TO THE FIREARM.”

Wisconsin:

“IF YOU LEAVE A LOADED FIREARM WITHIN THE REACH OR EASY ACCESS OF A CHILD YOU MAY BE FINED OR IMPRISONED OR BOTH IF THE CHILD IMPROPERLY DISCHARGES, POSSESSES, OR EXHIBITS THE FIREARM.”

* * * * *

Please check with your licensed retailer or state police for additional warnings which may be required by local law or regulation. Such regulations change constantly, and local authorities are in the best position to advise you on such legal matters.

FIREARMS SAFETY IS YOUR RESPONSIBILITY
SAFETY MUST BE THE FIRST AND CONSTANT
CONSIDERATION OF EVERY PERSON WHO HANDLES
FIREARMS AND AMMUNITION.

This Instruction Manual is designed to assist you in learning how to use and care for your **RUGER® SR1911®** pistol properly. Please contact us if you have any questions.

Only when you are certain you fully understand the manual and can properly carry out its instructions should you practice loading, unloading, etc. with live ammunition. If you have any doubts about your ability to handle or use a particular type of firearm safely, you should seek supervised instruction. Such personalized instruction often is available from local firearm retailers, gun clubs or police departments. If none of these sources can help, visit nra.org or write to the following address:

National Rifle Association
11250 Waples Mill Road
Fairfax, VA 22030-7400

The person possessing a firearm has a full-time job. You cannot guess; you cannot forget. You must know how to use your firearm safely. **Do not use any firearm without having a complete understanding of its particular characteristics and safe use.** Remember: There is no such thing as a foolproof firearm.

TABLE OF CONTENTS

State-By-State Warnings	2
Nomenclature	8
Locking Device Installation Instructions	9
General Information and Mechanical Characteristics	11
Operation of Manual Safety	13
Ammunition	14
Inspecting Your Pistol	15
To Load and Fire	16
Visual Inspection Port	18
Dry Firing	18
To Uncock (Decock) the Pistol	19
To Unload	21
To Reload The Pistol	22
To Extract and Eject a Chambered Cartridge	22
To Clear a Malfunction (“Jam” or “Misfire”)	23
To Minimize Malfunctions (“Jams” or “Misfires”)	23
Disassembly/Reassembly:	
NOTE – Instructions Vary Depending Upon the Particular Model of SR1911	24
Magazine Inspection and Care	46
Care and Cleaning	46
Storage	49
Rear Sight Adjustment	49
Service and Parts Policy	50
Shipping Firearms for Repair	50
Ordering Parts	51
SR1911® Parts List	52
SR1911® Exploded View	53
Officer-Style SR1911® Supplemental Parts List & Exploded View	54
The Basic Rules of Safe Firearms Handling	55
Warranty Information	60

“Ruger” is a registered U.S. trademark.



WARNINGS OF GREAT IMPORTANCE ARE FOUND ON THE FOLLOWING PAGES:

Locking Devices	9	Handling	19
Alterations	11	Unloading	21
Manual Safety	13	Malfunctions	23
Safety	13	Disassembly	25
Ammunition	14	Lubrication	48
Lead Exposure	14	Storage	49
Slide Retraction	17	Shipping	50
Firing	17	Parts Purchasers	51

**OTHER CAUTIONS AND WARNINGS APPEAR
THROUGHOUT THE MANUAL.**

NOMENCLATURE

Standard Model Shown – Not All Models Contain all of These Features

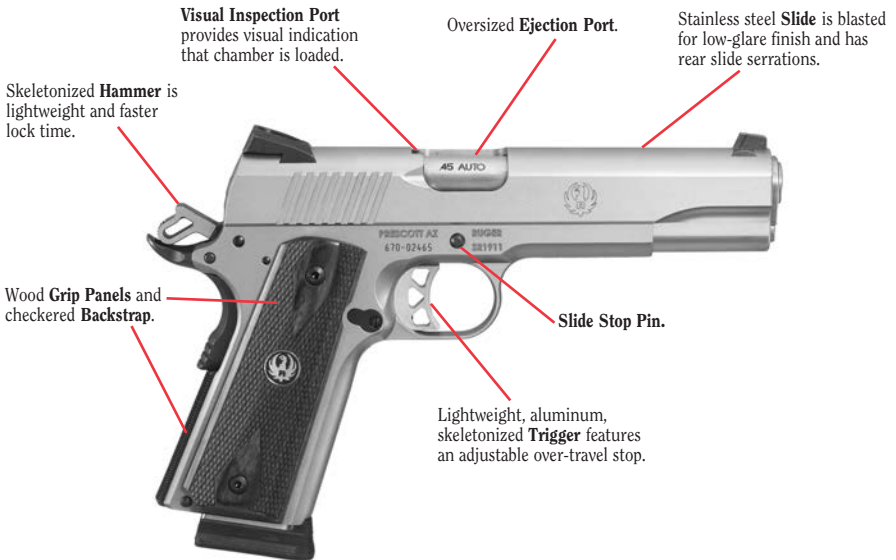
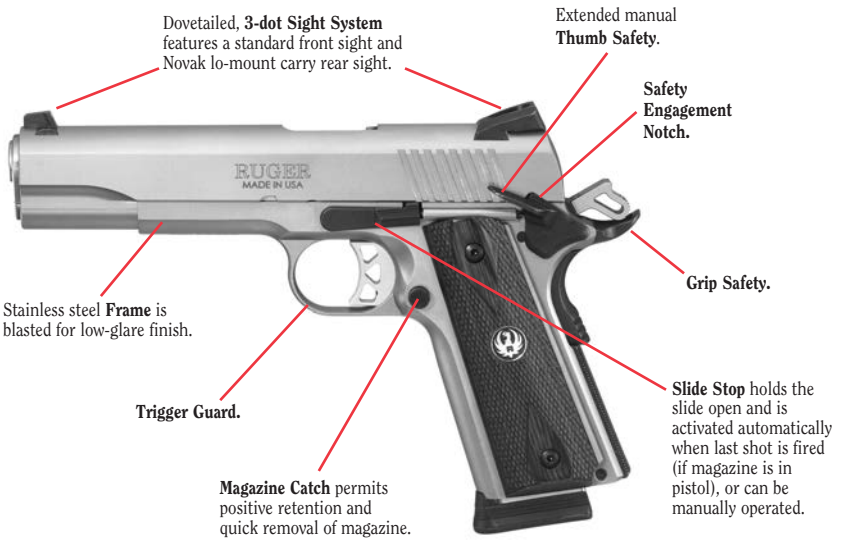

LOCKING DEVICE INSTALLATION INSTRUCTIONS



WARNING – USE OF LOCKING DEVICES



**Do not store keys
in lock.**

- Always keep your firearm pointed in a safe direction, including when you are installing or removing your locking device.
- Always verify that your firearm is completely **unloaded** (see pgs. 21 - 22) before installing your locking device.
- Do **not** install locking devices in the trigger guard; always keep your fingers and locking device outside the trigger guard during device installation and removal.
- Store firearms, ammunition and keys separately and securely, away from children and careless adults; do **not** store your firearm with the keys in the locking device.
- Do not attempt to work the action of your firearm with the locking device in place; this may damage your firearm.
- While locking devices are an important aid to security measures, they are not a substitute for safe firearm handling and proper storage. Remember that any mechanical device can be bypassed with enough time, knowledge, determination and equipment.

**LOCKING DEVICES MUST BE USED
SAFELY AND RESPONSIBLY**

It is important to use the locking device on your Ruger® firearm when the firearm is stored or immediate use is not planned.

Keep the muzzle pointed in a safe direction and your fingers outside the trigger guard at all times during installation of the locking device!

To Install the Factory-Supplied Locking Device:

1. Remove the magazine from your pistol.
2. Open the action completely, and verify that the firearm is completely unloaded and contains no cartridges or cartridge cases!

Use the slide stop to keep the action open during installation of the locking device.



3. Insert the cable directly into your pistol as shown in Figure 1.
4. To lock: With the key turned to the farthest clockwise position, insert the loose end of the cable into the lock. Turn the key counterclockwise and remove the key.
5. Once the lock is securely closed, pull firmly on the cable to test the connection and be sure it is locked. **Do not leave or store your firearm with the key in the lock!** Store your locked, unloaded firearm and the key in secure, separate locations, away from ammunition, children, and unauthorized adults.



Figure 1

Correct installation of the lock on a Ruger® SR1911® pistol.

**FIREARMS ARE DANGEROUS WEAPONS.
READ THE INSTRUCTIONS AND WARNINGS IN THIS
MANUAL THOROUGHLY AND CAREFULLY BEFORE USING.**

 WARNING - ALTERATIONS	
	This product was designed to function properly in its original condition. Alterations can make it unsafe. Do not alter any part or add or substitute parts or accessories not made by Sturm, Ruger & Co., Inc.
	DO NOT ALTER ANY FIREARM

GENERAL INFORMATION AND MECHANICAL CHARACTERISTICS

The **RUGER® SR1911®** pistol features a titanium firing pin and has no firing pin block, often referred to as a Series 70 design. Other safety features are a beavertail style grip safety and thumb safety. The thumb safety is extended for improved positive manipulation under all conditions. A visual inspection port permits visual inspection of the chamber to determine if the pistol is loaded.

Positive extraction is facilitated by an improved internal extractor. The plunger tube for slide stop and thumb safety is integral to the frame, not staked as in many 1911 versions, and will never come loose. The press fit link pin will also not come loose or come out.

There are three hammer positions on your **RUGER® SR1911®** pistol: **AT REST** (fully forward), **FULLY COCKED** (fully rearward) and **HALF-COCKED**.

The **AT REST** (fully forward) position is when the face of the hammer is resting on the firing pin. The pistol should never be carried or left **AT REST** on a loaded chamber. It should only be carried **AT REST** on an empty chamber.

The **FULLY COCKED** (fully rearward) position is when the hammer is pulled all the way back to the second click point. This is the fire position and pulling the trigger when the hammer is in this position will cause the pistol to fire (assuming it is loaded). If carrying the pistol in the **FULLY COCKED** position, the manual safety should always be engaged.

The **HALF-COCKED** hammer position is designed to serve as an automatic safety in the event of an unintentional hammer fall and should not be used in normal operation. If the hammer is pulled back beyond this point and inadvertently released, the hammer will drop into this position and will not contact the firing pin. The hammer should not intentionally be placed in this position – this is not a manual safety, nor should it be used in that manner.

Never attempt to fire the pistol from the half-cocked position. To remove the hammer from this position, point the firearm in a safe direction and, with your finger off the trigger and outside the trigger guard, pull the hammer all the way back to the fully cocked position. The pistol can then be fired at the intended target, if desired. If not, fully unload the pistol (remove the magazine and clear the chamber), point the pistol in a safe direction, then carefully decock the pistol (see “To Uncock (Decock) the Pistol” p. 19).



THE PISTOL SHOULD NEVER BE CARRIED OR LEFT AT REST ON A LOADED CHAMBER. IT SHOULD ONLY BE CARRIED AT REST ON AN EMPTY CHAMBER. IF CARRYING THE PISTOL IN THE FULLY COCKED POSITION THE MANUAL SAFETY SHOULD ALWAYS BE ENGAGED. NEVER CARRY THE PISTOL IN THE HALF-COCKED POSITION.

The **SR1911**[®] pistol includes the following features with which users should be thoroughly familiar:

Action: The action of the **RUGER**[®] **SR1911**[®] pistol is of the U.S. M1911 type that utilizes a tilting barrel design in which the barrel and slide are locked together at the moment of firing. After firing, the barrel and slide recoil to the rear a short distance while still locked together. After this initial movement, the barrel is cammed downward from its locked position, permitting full recoil of the slide and the extraction and ejection of the spent cartridge case. Upon return of the slide to its forward position by the recoil spring, the barrel is cammed back upward into its locked position in the slide.

The user of this or any autoloading pistol must always remember that when fired, it automatically reloads and recocks itself, so that simply pulling the trigger will fire the pistol again. Therefore, an autoloading pistol user must be particularly conscious to always keep the pistol pointed in a safe direction.

Slide Stop: When the last shot has been fired and the magazine is empty, the slide stop automatically holds the slide open. When there is an empty magazine in the pistol and the slide is retracted manually, the slide stop will also automatically hold the slide open. If a loaded magazine is inserted in the pistol when the slide is closed and the slide is then retracted fully, the slide stop will not automatically hold open the slide. The user can actuate the slide stop mechanism to hold the slide open at any time by retracting the slide and pushing the slide stop up into the up position.

When there is no magazine inserted or when a loaded magazine is inserted, the slide stop can be released by drawing back slightly on the slide and releasing it. When an empty magazine is inserted, the slide stop can be released by drawing back slightly on the slide, depressing the slide stop thumb piece and releasing the slide.

If there is a loaded magazine in place and the pistol is jarred, the slide can fly forward and chamber a cartridge. For this reason and as an essential safety practice, the user should always be careful to keep fingers away from the trigger, and always keep the pistol pointed in a safe direction.

Magazines: The **RUGER**[®] **SR1911**[®] pistol magazines are not interchangeable with Ruger pistol magazines of any other caliber even though they may appear similar and may hold other cartridges. Use only **GENUINE RUGER**[®] **FACTORY** magazines designated for your firearm. The use of incorrect magazines in any pistol will result in malfunctions.

Overtravel Trigger Adjustment: Overtravel is the distance the trigger moves rearward after the sear has disengaged from the sear notch of the hammer. The overtravel of each **SR1911**[®] pistol trigger is factory preset. If there is not enough overtravel, the sear may not disengage the hammer sufficiently, causing the hammer to drop to the half cock notch. This condition can prevent the pistol from firing and cause damage to both the hammer and sear. For this reason, we do not recommend adjusting the **SR1911**[®] pistol overtravel and we do not provide an adjustment tool with the pistol.

OPERATION OF MANUAL SAFETY

The model you have selected is equipped with a manual thumb safety on the left side of the pistol. It is important to familiarize yourself with the manual safety lever on your pistol. When the safety lever is fully down as shown in Figure 2 (notice NO engagement between safety lever and Safety Engagement Notch), it is in the “fire” position; when the safety lever is fully up, as shown in Figure 3 (notice FULL engagement between safety lever and Safety Engagement Notch), it is in the “safe” position. The manual safety lever can only be placed in the “safe” position when the hammer is fully cocked.

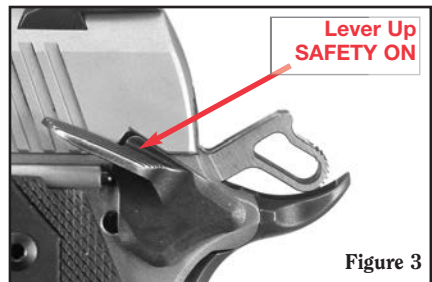
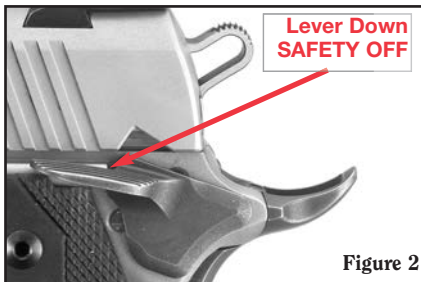

WARNING - MANUAL SAFETY



Placing the safety in an intermediate position between “safe” and “fire” can result in the user thinking the pistol is in a safe or fire position when it is not. Pulling the trigger with the safety in an intermediate position may cause the pistol to fire. Therefore, always move the safety fully to its intended position and then check to be sure it is where you want it to be.

NEVER PUT SAFETY 1/2 ON



WARNING - SAFETY





To place the safety in the fully up (“safe”) position, the slide must be forward and the hammer must be in the fully cocked position. Attempting to place the safety in the up position while the hammer is not fully cocked will allow only partial movement of the lever and will not engage the safety. Always make sure the manual safety lever is properly engaged.

HAMMER MUST BE FULLY COCKED TO ENGAGE SAFETY

AMMUNITION



The **RUGER® SR1911®** pistols are compatible with all factory ammunition of the correct caliber loaded to U.S. Industry Standards, including high-velocity and hollow-point loads, loaded in brass, aluminum, or steel cartridge cases. No ammunition manufactured in accordance with NATO, U.S., SAAMI, or CIP standards is known to be beyond the design limits or known not to function in these pistols.

Be certain to use the correct cartridge for your pistol, and do not attempt to load any other cartridges into the magazine or chamber of the pistol.

 WARNING – AMMUNITION	
	<p>Use only new, factory ammunition of the correct caliber.</p> <p>Death, serious injury, and damage can result from the wrong ammunition, bore obstructions, powder overloads or incorrect cartridge components.</p> <p><u>Always</u> wear shooting glasses and hearing protection.</p>
IMPROPER AMMUNITION DESTROYS FIREARMS	

AMMUNITION (CARTRIDGES) NOTICE

WE SPECIFICALLY DISCLAIM RESPONSIBILITY FOR ANY DAMAGE OR INJURY WHATSOEVER OCCURRING IN CONNECTION WITH, OR AS THE RESULT OF, THE USE IN RUGER® PISTOLS OF FAULTY, OR NONSTANDARD OR “REMANUFACTURED” OR HANDLOADED (RELOADED) AMMUNITION OR OF CARTRIDGES OTHER THAN THOSE FOR WHICH THE FIREARM WAS ORIGINALLY CHAMBERED.

 WARNING - LEAD EXPOSURE	
	<p>Discharging firearms in poorly ventilated areas, cleaning firearms, or handling ammunition may result in exposure to lead and other substances known to the State of California to cause birth defects, reproductive harm, and other serious physical injury. Have adequate ventilation at all times. Wash hands thoroughly after exposure.</p>
SHOOTING OR CLEANING FIREARMS MAY EXPOSE YOU TO LEAD	

INSPECTING YOUR PISTOL

It is important to inspect your pistol periodically to verify that it is in good operational condition and is functioning correctly. To do this:

1. Always start by verifying that the pistol is completely unloaded. Begin by grasping the pistol normally, keeping the muzzle pointed in a safe direction, your finger off the trigger, and your fingers outside the trigger guard.
2. Depress the magazine release and remove the magazine (See Figure 4). Be careful not to let the magazine drop to the ground as this may damage the magazine.
3. If the firearm is cocked, depress the manual safety lever to ensure that it is disengaged. (See Figure 2, p. 13).
4. Grasp the serrations on the rear of the slide as shown in Figure 5 and draw the slide briskly to the rear to extract any cartridge from the chamber and eject it from the pistol. Be careful not to obstruct the ejection port as this could interfere with ejection of the cartridge.
5. Lock the slide open by allowing it to move forward slightly from the rearmost position while pressing the slide stop upward.
6. Check the chamber and bore for any live rounds or obstructions. Examine the breech face (see Figure 6) to ensure that the firing pin is not protruding.

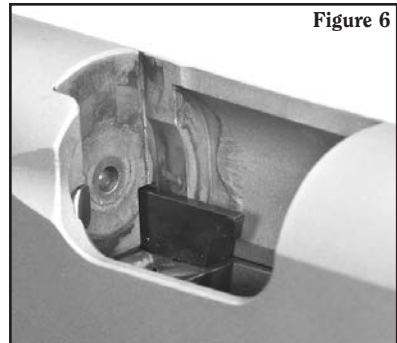
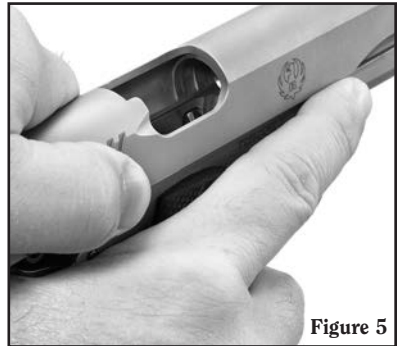

TO LOAD AND FIRE

Practice this important aspect of safe firearm handling with an unloaded pistol until you can perform each of the steps described below with skill and confidence. **But before you do anything with the pistol, first read completely through this manual.**

1. **Be certain the muzzle is pointed in a safe direction.** (See “The Basic Rules of Safe Firearms Handling,” page 55.)
2. Press the magazine catch inward from the left side and remove the magazine from the frame. **NOTE:** The magazine is designed to fall free of the frame of its own weight when unloaded, the slide is locked open and the pistol is held in the normal firing position, but you should always prevent possible damage to the magazine by not letting it drop to the ground unless rapid reloading is absolutely necessary.
3. Load the magazine with the appropriate number of cartridges.
4. Insert the magazine into the frame, taking care that the magazine is locked in place by the magazine catch. Slamming the magazine into the frame forcibly is not necessary.
5. Hold the pistol firmly in the shooting hand but **do not touch the trigger.** **Keep the pistol pointed in a safe direction.** With the thumb and forefinger of the other hand grasp the rear of the slide and pull the slide to the rear as far as it will go (see Figure 7, below and “Slide Retraction Warning,” p. 17). When released, the slide will fly forward to strip the top cartridge from the magazine and chamber it.

WARNING: The pistol is ready for instant use once the slide moves forward if the safety is in the “fire” position. Be careful!



Figure 7
Slide in Retracted Position



WARNING - SLIDE RETRACTION



The slide should always be pulled rearward (“retracted”) by pulling the rear portion of the slide in the vicinity of the serrations. **Always keep fingers away from trigger!**



Never put any part of your hands or body over the muzzle while retracting the slide for loading, unloading, inspection, or clearing a malfunction.

**KEEP HANDS
AWAY FROM MUZZLE AND
FINGER OFF TRIGGER**

6. If the pistol is not to be fired immediately, the manual safety lever should be placed in the “safe” position (see Figure 3, p. 13).
7. If the pistol is to be fired immediately, the manual safety lever can be left in its downward or its “fire” position (see Figure 2, p. 13).
8. **The pistol is ready for instant use when the safety is disengaged.** When the pistol is in the “uncocked” mode (hammer forward), the first shot can be fired by manually cocking the hammer to the rear and by pulling the trigger all the way to the rear, which fires the pistol. **Keep your finger off the trigger while cocking the hammer!** Subsequent shots are fired single-action until the magazine is empty, the hammer being cocked by the slide as it recoils from each shot.



WARNING - FIRING



The slide automatically opens and shuts quickly while firing. Keep face and hands away from rear. Hot brass is ejected quickly and can burn you. Always wear shooting glasses and hearing protection.

**SLIDE OPENS FAST -
HOT BRASS EJECTED**

9. Immediately following the firing of a shot, and if a subsequent shot is not to be fired at once, put the safety in its “safe” position (manual safety lever fully upward) while the pistol is still pointing in a safe direction downrange.
10. When the last cartridge loaded into the pistol has been fired, the magazine follower presses the slide stop upward to engage the slide automatically holding the action open. If the slide is shut, the shooter should always assume that there is a cartridge in the chamber!

Don't rely on your memory to know if a firearm or magazine is loaded. With the pistol pointed in a safe direction, visually inspect the magazine and chamber.

VISUAL INSPECTION PORT

You should always treat every firearm as though it is loaded and always keep the muzzle pointed in a safe direction. Never rely upon any safety or mechanical device to justify unsafe or careless firearm handling. In order to assist you in determining the presence of a cartridge in the chamber of your **RUGER® SR1911®** pistol, it is equipped with a visual inspection port. The inspection port is located at the top of the slide/ejection port, see Figure 8. (See “Nomenclature,” p. 8.) To determine whether there is a cartridge in the chamber, carefully look into the visual inspection port for the presence of a cartridge in the chamber.

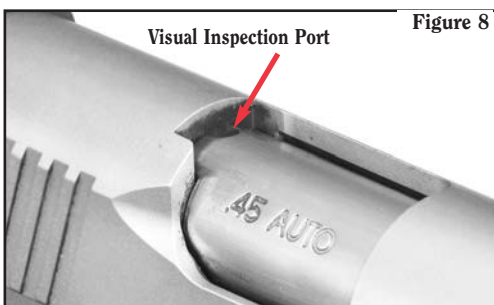

NEVER RELY ON YOUR MEMORY OR THE VISUAL INSPECTION PORT TO KNOW IF A FIREARM IS LOADED. ALWAYS VISUALLY CHECK THE CHAMBER BY RETRACTING THE SLIDE AND EXAMINING THE CHAMBER TO BE SURE WHETHER IT IS EMPTY OR LOADED.

DRY FIRING

Going through the actions of cocking, aiming and pulling the trigger on an unloaded firearm is known as “dry firing.” It can be useful to learn the “feel” of your pistol. Be certain that the pistol is fully unloaded (both the chamber and magazine are empty) and that the pistol is pointing in a safe direction even when you are practicing dry firing. The **RUGER® SR1911®** pistols can be dry-fired without damage to the firing pin or other components.

WARNING - HANDLING



Do not load the pistol until you are ready to use it, and unload it immediately when you have completed shooting. (See “Warning - Unloading” on page 21.)

If dropped or struck, the pistol may fire. Keep the chamber empty unless actually firing! Use the manual safety lever before moving with the pistol or when not actually firing.

For maximum safety when carrying the pistol with a loaded magazine in place, the chamber should be empty, the slide should be closed, and the pistol should be decocked.

The user should never depend on any mechanical device to justify careless handling or permitting the pistol to point in an unsafe direction. The shooter should always be alert to the possibility of accidental discharge. **The only absolutely safe pistol is one in which the slide is open, the chamber is empty, and there is no magazine in the firearm.**

**ANY FIREARM MAY FIRE IF
DROPPED**

TO UNCOCK (DECOCK) THE PISTOL

WARNING: ALWAYS KEEP THE PISTOL POINTED IN A SAFE DIRECTION WITH YOUR FINGER OFF OF THE TRIGGER AND OUTSIDE THE TRIGGER GUARD.

WARNING: YOU MUST BE CERTAIN THAT THE CHAMBER IS UNLOADED. FAILURE TO VERIFY THE CHAMBER IS UNLOADED COULD RESULT IN THE PISTOL ACCIDENTALLY FIRING IF THE HAMMER SLIPS DURING DECOCKING.

If you decide not to fire and your handgun is in the fully cocked position, you must follow these instructions to safely decock your handgun.

1. Point the muzzle in a safe direction and remove your finger from the trigger and the trigger guard.
2. Place the manual safety lever in the fully up “safe” position. (See Figure 3, p. 13.)
3. Remove the magazine from the firearm. (See Figure 4, p. 15.)
4. Place the safety lever in the fully down “fire” position. (See Figure 2, p. 13.)
5. Draw the slide back briskly to eject any chambered round. You must visually and physically verify the chamber is free of any live rounds or obstructions. (See Figure 9.) Release the slide allowing it to move fully forward.

Figure 9

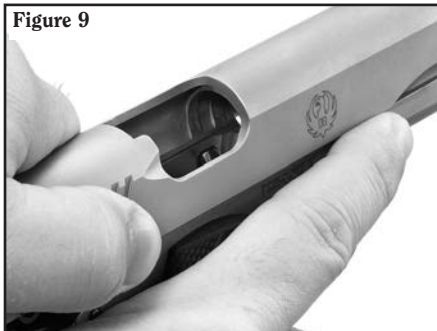

6. **BE SURE THE PISTOL IS UNLOADED AND POINTED IN A SAFE DIRECTION. NEVER DO THIS WITH A LOADED FIREARM.** Place your finger on the trigger and place the thumb of your opposite hand on the hammer. (See Figure 10.)



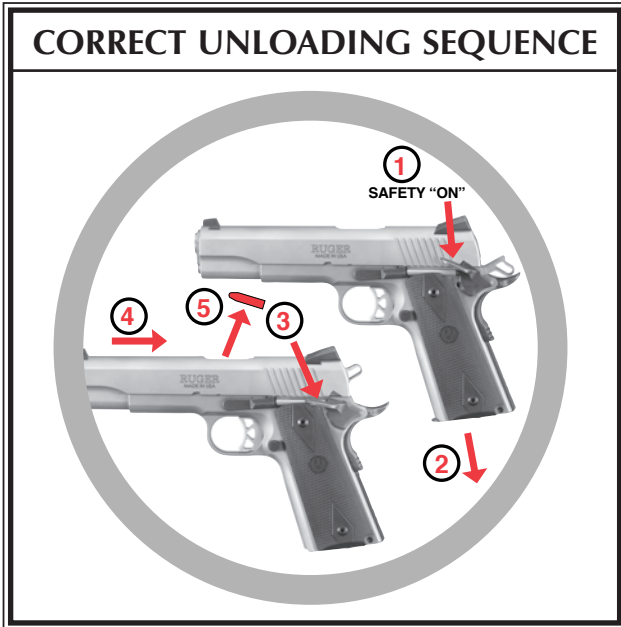

7. Pull the trigger to the rear and hold it while lowering the hammer to the forward position with your thumb and then release the trigger. (See Figure 11.)



TO UNLOAD

WARNING: This sequence must be followed exactly as outlined. Failure to do so can result in the chamber being unintentionally loaded with a live cartridge!

1. The muzzle of the pistol must be pointing in a safe direction at all times, and fingers should be outside of the trigger guard. Ensure that the hammer is fully rearward and put the safety lever in its “safe” position (see Figure 3, p. 13).
2. Remove the magazine from the pistol by pushing in on the magazine catch. **REMEMBER** that even though the magazine has been removed, a live round may remain in the chamber and the pistol can fire with the magazine removed. (See “Warning - Unloading,” below.)
3. Place the safety lever into the down or “fire” position.
4. With the muzzle of the pistol pointing in a safe direction, and fingers outside of the trigger guard, hold the pistol firmly and grasp the slide. Retract the slide to its rearmost position briskly to extract and eject any chambered cartridge. Always double check visually that the chamber, breech-face, and the interior of the frame are clear of any live rounds. When the slide is fully retracted, push upward on the slide stop, then allow the slide to move forward until it comes to rest with the rear projection of the slide stop resting in the notch on the lower left side of the slide.
5. To close the slide, **again check to be sure the chamber is empty.** Pull the slide to its rearmost position and release it. The slide will snap forward. Keep fingers out of ejection port on top of slide!
6. Lower the hammer by following the steps for uncocking (decocking) the pistol on pgs. 19 - 20.
7. If the magazine contains cartridges, they can be removed by sliding each cartridge forward and out of magazine, one at a time, until the magazine is empty.
8. Push empty (unloaded) magazine into frame until magazine catch locks it in place.

 WARNING - UNLOADING	
	Removing magazine does not unload pistol! To unload, <u>first</u> remove magazine, <u>then</u> pull slide to rear, eject chambered cartridge, and <u>visually inspect chamber to be sure it is empty.</u> Always point the pistol in a safe direction when loading or unloading.
	REMOVING MAGAZINE DOES NOT UNLOAD CHAMBER

TO RELOAD THE PISTOL



1. Firing all cartridges in the magazine and the chamber will cause the slide to automatically lock open. **Keep the pistol pointed in a safe direction.** Press on the magazine catch with the thumb or forefinger. The magazine will fall free of the pistol of its own weight if the slide is locked open. To avoid the possibility of damage to the magazine, do not let it fall to the ground unless rapid reloading is absolutely necessary.
2. Insert a loaded magazine. **WARNING: The slide stop is held in place by the slide pressing against the rear of the slide stop. Therefore, when there is a loaded magazine in place and the pistol is jarred, the slide can fly forward and chamber a cartridge.**
3. Release the slide to move forward by pulling the slide fully to the rear and release it. A cartridge will be chambered when the slide shuts. **WARNING: The pistol is ready to fire once the manual safety is disengaged.**
4. If the pistol is not to be fired immediately, move the manual safety lever fully upward to the “safe” position. **Keep the safety “on” at all times except when actually firing.** When you are finished firing the pistol, unload it completely (see p. 21).

TO EXTRACT AND EJECT A CHAMBERED CARTRIDGE

When the pistol is fired, the same gas pressure that drives the bullet forward also acts through the cartridge case to push the slide to the rear. The action causes extraction and ejection of the fired cartridge case. If a cartridge fails to fire or if the shooter wishes to eject the chambered cartridge manually, follow the procedure “To Unload,” p. 21. When the slide is operated by hand, there can be a failure to extract the cartridge from the chamber, or a failure to eject the cartridge clear of the pistol. These failures usually are the result of the slide not being pulled rearward vigorously. From the foregoing, it is clear that the firearm user must:

1. Always visually check the chamber and the breech-face after opening the slide to eject a chambered cartridge. If the slide is not vigorously retracted when being operated by hand, the extracted cartridge can be “ejected” into the magazine-well of the grip frame or remain held to the breech-face by the extractor.
2. Thoroughly clean the chamber and the extractor as often as necessary.

If an empty magazine is in the pistol when the slide is being hand retracted to extract a cartridge, the cartridge may drop on top of the magazine or remain held to the breech-face by the extractor. Then when the slide goes forward, the cartridge will be chambered again! **Remember — always remove the magazine before clearing the chamber, and visually ensure that no cartridges remain anywhere in the firearm.**

! WARNING - MALFUNCTIONS	
	<p>Any autoloading pistol may occasionally malfunction. If a cartridge hangs up, jams, or binds when being chambered, do not attempt to force it into the chamber by pushing or striking the slide. Carefully remove it.</p> <p>Most failures of a cartridge to feed or to chamber properly are caused by a damaged magazine, incorrect firearm handling, insufficient lubrication, or improper ammunition.</p> <p>Whatever the cause, the user of the pistol must, above all, recognize that any cartridge jam can result in the potentially very dangerous situation of a cartridge discharging before it is properly chambered. If this happens, the cartridge case may rupture and its fragments fly out of the ejection port of the pistol with sufficient force to cause serious injury. Always wear shooting glasses!</p>
	HITTING PRIMER CAN BURST CARTRIDGE

TO CLEAR A MALFUNCTION (“JAM” or “MISFIRE”)

1. Be certain the muzzle is continually pointed in a safe direction and that the safety lever is in the “safe” position.
2. If the misfire is the result of a cartridge not firing or unusual report (either louder or quieter than normal), keep the pistol pointed in a safe direction for 30 seconds prior to ejecting the chambered round or retracting the slide.
3. If possible, remove the magazine. It may be necessary to manually remove a jammed cartridge that has only been partially stripped from the magazine. If so, use extreme care. Lock the slide open with the slide stop before attempting to clear the jam. Drawing the slide fully to the rear may bring the jammed cartridge along. **Keep your face away from the ejection port during this operation.** When attempting to clear a jam, use only wood “tools” so that the cartridge will not be damaged or the primer ignited. A 3/16” wooden dowel with a point on one end is useful. Carefully remove the jammed cartridge from the chamber and dispose of it properly.
4. Visually check to make sure that all cartridges have been removed from the pistol. Safely dispose of any cartridges involved in a malfunction incident. Do not use damaged ammunition in any firearm.

TO MINIMIZE MALFUNCTIONS (“JAMS” or “MISFIRES”)

1. If it appears that the jam was caused by the type of ammunition being used, try another brand, type, or lot number. Remember — use only factory ammunition of the correct caliber.
2. If changing ammunition does not at once eliminate malfunctions, then the following steps should be taken:
 - a. Thoroughly clean the pistol, paying particular attention to the removal of accumulated grease and dirt. Use a bristle brush and solvent to remove grease and fouling from the breech-face, extractor, chamber, and feed ramp area immediately behind the chamber.

- b. Check to be sure that the magazine spring firmly returns the magazine follower to the top of the magazine.
- c. Check the magazine lips to be certain that they are free of nicks and burrs and that they are not deformed or cracked.
- d. Remove excess oil and solvent from all cleaned components, load the magazine, and try the pistol again. Make sure you are following the correct loading and firing sequence as described in this manual.
- e. If none of the above steps is effective, try a different magazine of Ruger® manufacture. If a new magazine does not function correctly, return the pistol and magazines to the Ruger Customer Service Department. (See “Shipping Firearms For Repair” on page 50.)
- f. **Alterations to the pistol or use of non-Ruger magazines and accessories may cause malfunctions. See “Warning - Alterations” on page 11.**

DISASSEMBLY/REASSEMBLY

Be sure firearm is unloaded!

NOTE: Disassembly and reassembly instructions vary depending upon the particular model of **SR1911®**. Be sure you are following the correct instructions for your firearm.

Page

To Disassemble: Standard Barrel With Bushing25
To Reassemble: Standard Barrel With Bushing29
To Disassemble: Bull Barrel (Bushingless) Model (Except Officer-Style)31
To Reassemble: Bull Barrel (Bushingless) Model (Except Officer-Style)36
To Disassemble: Bull Barrel (Bushingless) Officer-Style Model39
To Reassemble: Bull Barrel (Bushingless) Officer-Style Model43

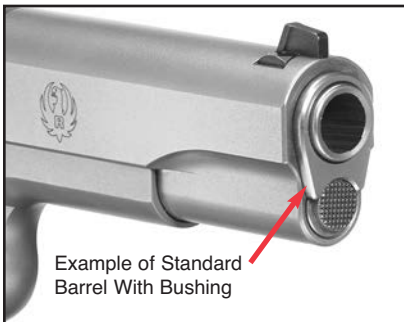

TO DISASSEMBLE: STANDARD BARREL WITH BUSHING

Be sure firearm is unloaded!

WARNING: FOR ROUTINE MAINTENANCE, IT IS UNNECESSARY TO DISASSEMBLE THE FIREARM BEYOND WHAT IS DESCRIBED IN THESE INSTRUCTIONS. ANY FURTHER DISASSEMBLY SHOULD BE PERFORMED BY A LICENSED GUNSMITH.

WARNING: WEAR SAFETY GLASSES EVERY TIME YOU ASSEMBLE OR DISASSEMBLE YOUR FIREARM.

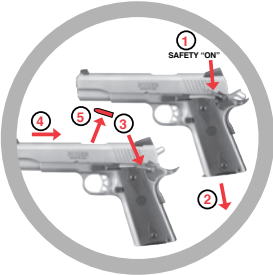
 WARNING - DISASSEMBLY	
	<p>Always unload a firearm before cleaning, lubrication, disassembly or assembly.</p>
UNLOAD BEFORE DISASSEMBLY	

1. Keep the pistol pointed in a safe direction and keep your fingers outside of the trigger guard. Press the magazine catch and withdraw the magazine from the butt of the pistol.
2. Pull the slide to the rear and lock it open by pressing upward on the rear end of the slide stop. Check the chamber and breech face to verify that the pistol is completely unloaded.
3. Pull the slide rearward, and allow it to go forward.
4. Firmly grasp the pistol as shown in Figure 12, use the wrench provided and depress the recoil spring retainer.

WARNING: THE RECOIL SPRING IS UNDER PRESSURE. YOU MUST CONTROL THE SPRING AND PLUNGER TO PREVENT IT FROM FLYING OUT AND CAUSING INJURY.

Turn the wrench and barrel bushing clockwise, approximately $\frac{1}{4}$ turn until the recoil spring plug and recoil spring are free.

Figure 12



5. Pull out the recoil retainer and spring (see Figure 13).
6. Fully cock the hammer.
7. Apply rearward pressure on the slide and move it back until the takedown notch in the left side of the slide is aligned with the rear portion of the slide stop as shown in Figure 14.

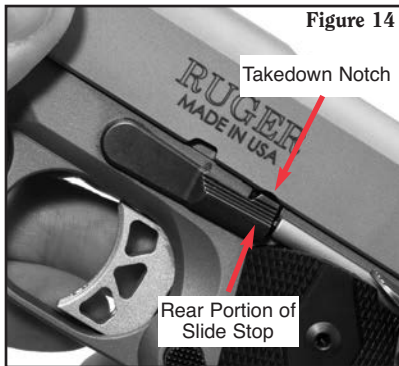

8. Press inward on the slide stop pin from the opposite side of the frame and remove the slide stop. (See Figures 15a and 15b.)



9. Position your hands so that the grip safety is not activated and move the slide forward off of the frame. (See Figure 16.)

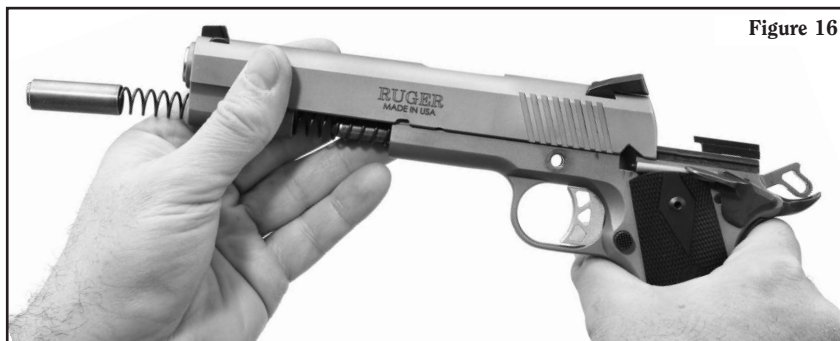

10. Turn the slide bottom up and remove the recoil spring guide rod. Move the guide rod upwards and away from the barrel, towards the rear of the slide. Rotate the barrel link into the “up” position to give the guide rod adequate clearance for removal. (See Figure 17.)

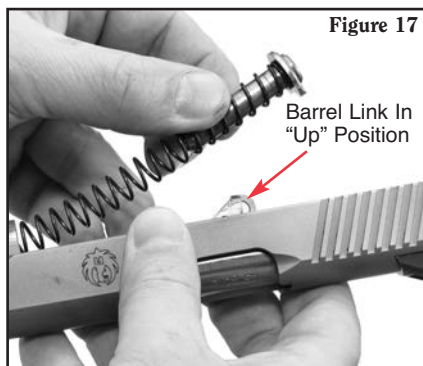

11. Rotate the barrel bushing counterclockwise until the bushing lug is aligned with the opening between the barrel and recoil spring holes. (See Figure 18.) Pull the barrel bushing out of the front of the slide.

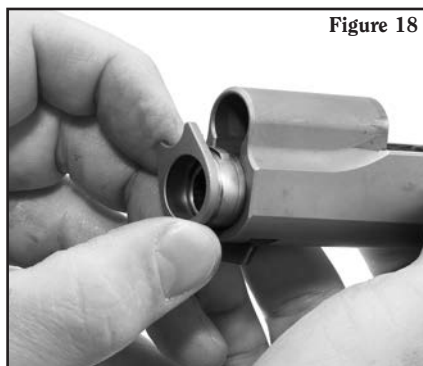

12. Rotate the barrel link to the forward position and remove the barrel through the front of the slide. (See Figure 19.)



13. Figure 20 shows the parts you will have after field stripping.



DO NOT DRY FIRE YOUR RUGER® SR1911® PISTOL WHILE THE SLIDE IS REMOVED. DOING SO CAN RESULT IN DAMAGE TO THE HAMMER OR OTHER INTERNAL PARTS.



DO NOT ALTER, MODIFY OR REPLACE ANY OF THE PARTS OF YOUR FIREARM UNLESS THE MODIFICATION IS PERFORMED BY A QUALIFIED GUNSMITH, USING GENUINE RUGER PARTS. IF YOU DO OTHERWISE, IMPROPER FUNCTION MAY OCCUR AND SERIOUS INJURY MAY RESULT.



NEVER DISASSEMBLE YOUR HANDGUN BEYOND THE FIELD STRIPPING PROCESS OUTLINED IN THIS MANUAL. NEVER MANIPULATE ANY INTERNAL COMPONENTS BEYOND WHAT YOU ARE SPECIFICALLY INSTRUCTED TO DO IN THIS MANUAL SINCE THIS MAY AFFECT THE RELIABILITY, FUNCTIONING AND SAFETY OF YOUR HANDGUN.



OTHER BRAND PARTS MUST NEVER BE USED IN YOUR RUGER® SR1911® EVEN THOUGH THE PARTS MAY APPEAR TO BE SIMILAR. USE OF ANY PARTS OTHER THAN GENUINE RUGER® SR1911® PARTS MAY CAUSE A SERIOUS MALFUNCTION RESULTING IN INJURY OR DEATH TO YOU OR OTHERS.

TO REASSEMBLE: STANDARD BARREL WITH BUSHING

WARNING: ALWAYS FOLLOW THE DISASSEMBLY AND REASSEMBLY INSTRUCTIONS EXACTLY. NEVER DO ANYTHING BEYOND WHAT YOU ARE SPECIFICALLY INSTRUCTED TO DO IN THIS MANUAL. NEVER ALTER OR MODIFY THE PARTS IN YOUR FIREARM.

WARNING: WEAR SAFETY GLASSES EVERY TIME YOU ASSEMBLE OR DISASSEMBLE YOUR FIREARM.

NOTE: An on-line video demonstrating the reassembly of the **RUGER® SR1911®** pistol can be viewed by going to **Ruger.com/TechTips**.

1. Verify that the hammer is in the fully cocked position. Ensure that the barrel chamber is unloaded and nothing is in the bore of the barrel.
2. Turn the slide bottom up, turn the barrel link forward and place the barrel into the slide from the front. See Figure 21.
3. Insert the barrel bushing into the slide and rotate it clockwise to lock it into place. See Figure 22.

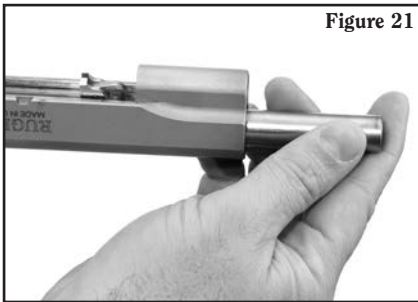

4. Insert the recoil spring guide rod into the recoil spring housing from the rear of the slide. See Figure 23.
5. Align the slide with the rails on the frame and gently push the slide onto the frame as shown in Figure 24. Do not squeeze the grip safety while putting the slide back onto the frame.

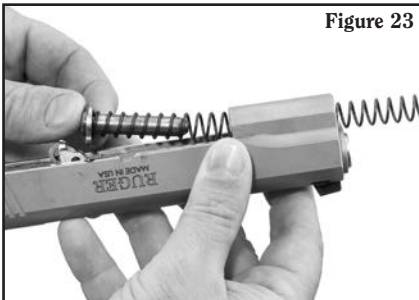

6. Move the slide and barrel rearward together until the barrel link hole is aligned with the slide stop hole. Insert the slide stop pin into the slide stop hole making sure it passes through the barrel link hole. (See Figure 25.) Align the takedown notch on the slide with the rectangular cutout of the frame. Push the slide stop pin all the way in so that its rearward tab passes through the takedown notch and is locked into place. (See Figure 26.)

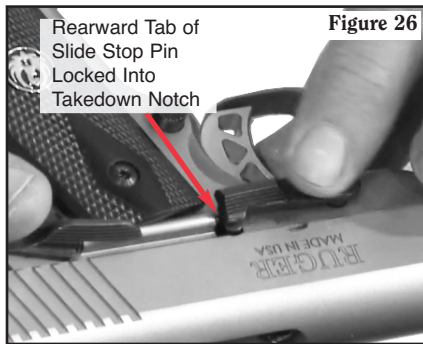
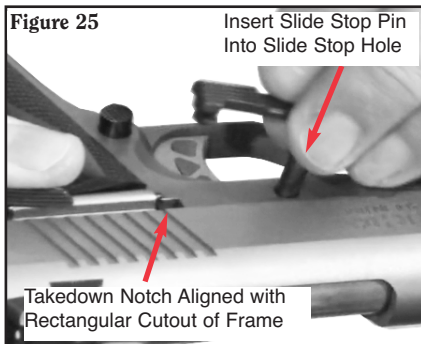

WARNING: THE RECOIL SPRING IS UNDER PRESSURE. YOU MUST CONTROL THE RECOIL SPRING AND THE GUIDE ROD SO THAT THEY DO NOT FLY OUT AND CAUSE INJURY.

7. Place the slide in the fully forward position. Turn the barrel bushing clockwise and then insert the recoil spring plug onto the recoil spring (closed end first). (See Figure 27.)

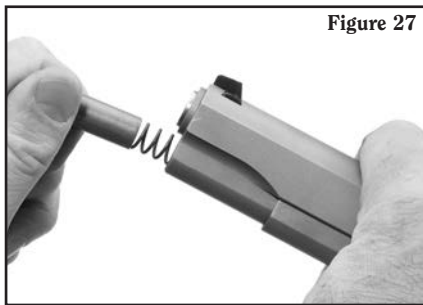

Use the barrel bushing wrench or your fingers and turn the bushing counter-clockwise (see Figure 28) until the recoil spring plug locks into place. (See Figure 29.)

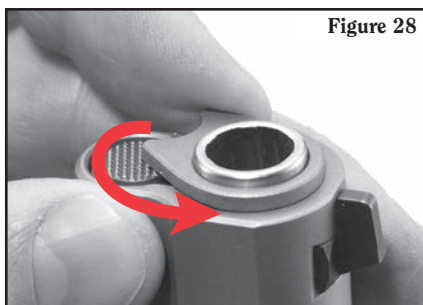

TO DISASSEMBLE: BULL BARREL (BUSHINGLESS) MODEL (EXCEPT OFFICER-STYLE)

Be sure firearm is unloaded!

WARNING: FOR ROUTINE MAINTENANCE, IT IS UNNECESSARY TO DISASSEMBLE THE FIREARM BEYOND WHAT IS DESCRIBED IN THESE INSTRUCTIONS. ANY FURTHER DISASSEMBLY SHOULD BE PERFORMED BY A LICENSED GUNSMITH.

WARNING: WEAR SAFETY GLASSES EVERY TIME YOU ASSEMBLE OR DISASSEMBLE YOUR FIREARM.

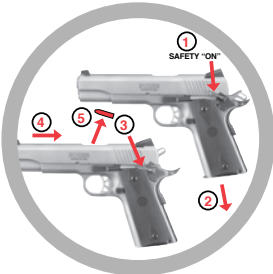
 WARNING - DISASSEMBLY	
	<p>Always unload a firearm before cleaning, lubrication, disassembly or assembly.</p>
UNLOAD BEFORE DISASSEMBLY	

1. Keep the pistol pointed in a safe direction and your fingers outside of the trigger guard. Press the magazine catch and withdraw the magazine from the butt of the pistol.
2. Pull the slide to the rear and lock it open by pressing upward on the rear end of the slide stop. Check the chamber and breech face to verify that the pistol is completely unloaded.

3. Insert the wire tool into the hole of the guide rod/recoil spring assembly. (See Figure 30).

NOTE: The wire tool is used to hold the recoil spring at its compressed length so that the guide rod/recoil spring assembly can be removed from the slide.

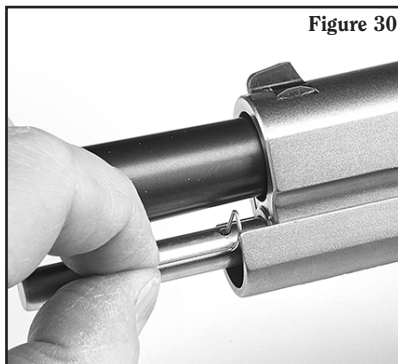

4. Apply rearward pressure on the slide to release the slide stop, then move the slide forward to align the takedown notch in the left side of the slide with the rear portion of the slide stop as shown in Figure 31.

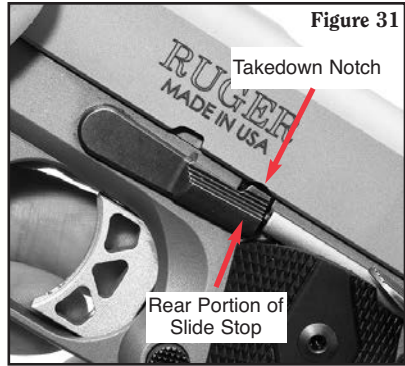

5. Press inward on the slide stop pin from the opposite side of the frame as shown in Figure 32a, and remove the slide stop (see Figure 32b).

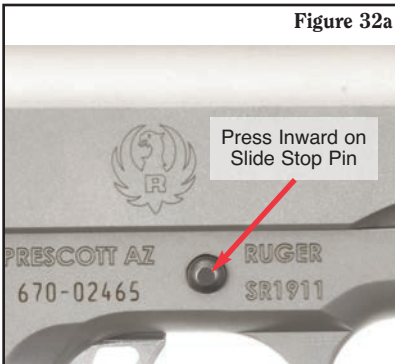

6. Move the slide forward off of the frame. (See Figure 33.)



7. Turn the slide bottom up and remove the guide rod/recoil spring assembly. To do this, move the guide rod assembly upwards and away from the barrel, towards the rear of the slide. (See Figure 34.)

Figure 34



8. Rotate the barrel link to the forward position (see Figure 35a) and remove the barrel through the front of the slide (see Figure 35b).

Figure 35a

Barrel Link Forward

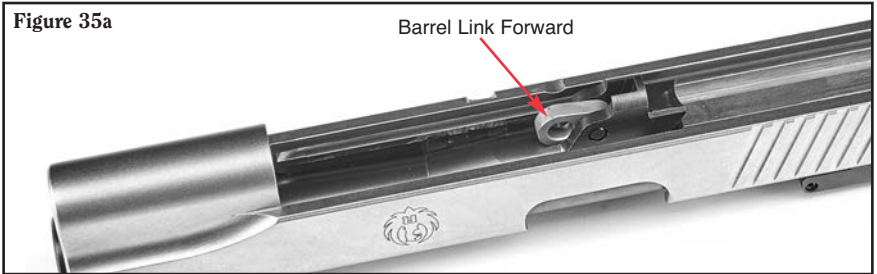
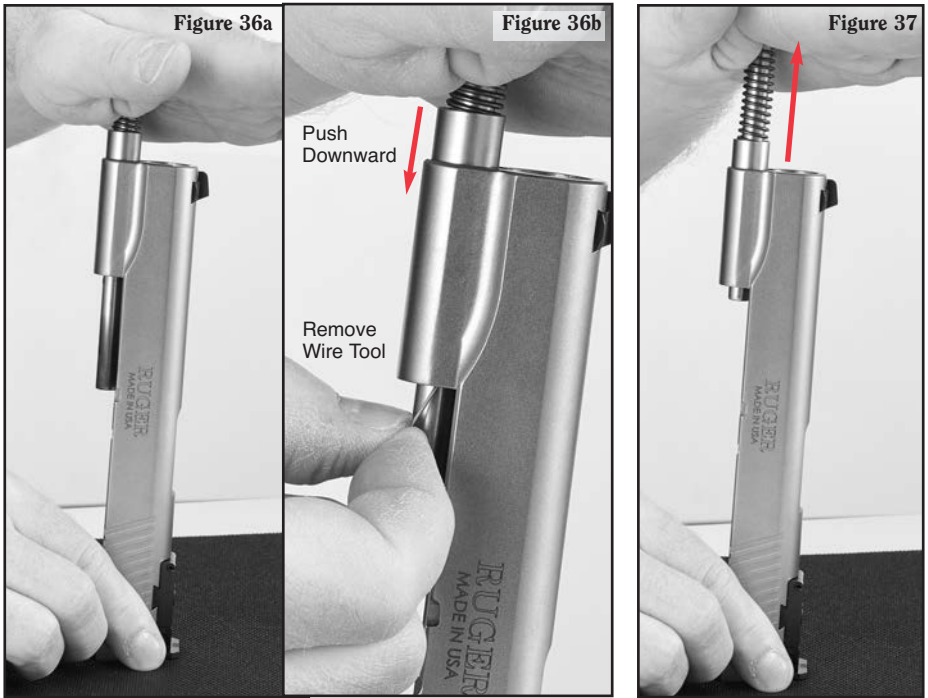

Figure 35b



9. In order to separate the recoil spring from the guide rod, insert the recoil spring/guide rod assembly back into the slide. **NOTE:** It may be helpful to place the rear of the slide on a firearm mat and push downward on the recoil spring/guide rod assembly with the palm of your hand while using the other hand to stabilize the slide as shown in Figure 36a. Apply enough pressure to the assembly so you can remove the wire tool. (See Figure 36b.)
10. Back the recoil spring/guide rod assembly out of the slide while maintaining control as **the spring is under high tension and can fly out and cause injury.** (See Figure 37.)



11. You can now separate the recoil spring, plug and guide rod (see Figure 38).

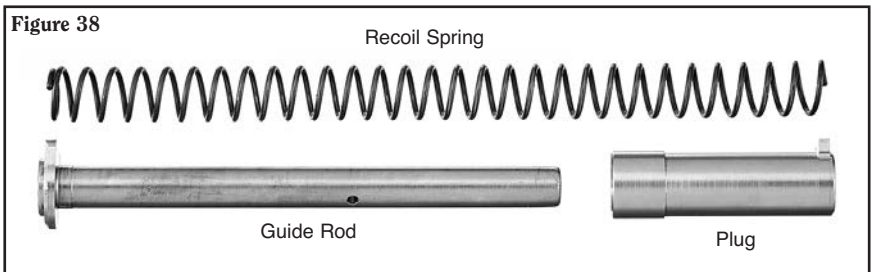

12. Figure 39 shows the parts you will have after field stripping.

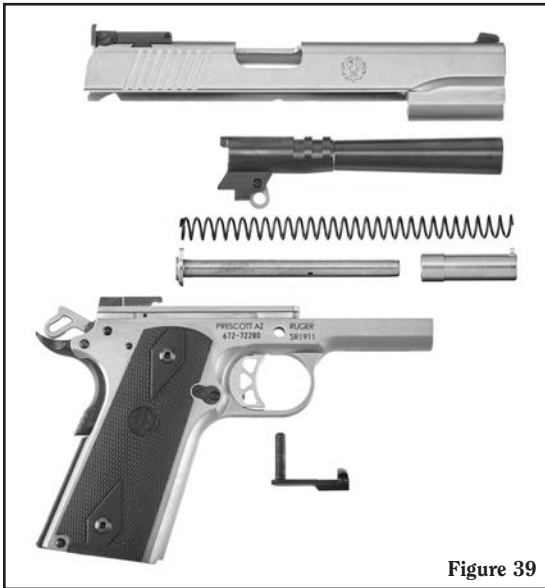

DO NOT DRY FIRE YOUR RUGER® SR1911® PISTOL WHILE THE SLIDE IS REMOVED. DOING SO CAN RESULT IN DAMAGE TO THE HAMMER OR OTHER INTERNAL PARTS.



DO NOT ALTER, MODIFY OR REPLACE ANY OF THE PARTS OF YOUR FIREARM UNLESS THE MODIFICATION IS PERFORMED BY A QUALIFIED GUNSMITH, USING GENUINE RUGER PARTS. IF YOU DO OTHERWISE, IMPROPER FUNCTION MAY OCCUR AND SERIOUS INJURY MAY RESULT.



NEVER DISASSEMBLE YOUR HANDGUN BEYOND THE FIELD STRIPPING PROCESS OUTLINED IN THIS MANUAL. NEVER MANIPULATE ANY INTERNAL COMPONENTS BEYOND WHAT YOU ARE SPECIFICALLY INSTRUCTED TO DO IN THIS MANUAL SINCE THIS MAY AFFECT THE RELIABILITY, FUNCTIONING AND SAFETY OF YOUR HANDGUN.



OTHER BRAND PARTS MUST NEVER BE USED IN YOUR RUGER® SR1911® EVEN THOUGH THE PARTS MAY APPEAR TO BE SIMILAR. USE OF ANY PARTS OTHER THAN GENUINE RUGER® SR1911® PARTS MAY CAUSE A SERIOUS MALFUNCTION RESULTING IN INJURY OR DEATH TO YOU OR OTHERS.

TO RESASSEMBLE: BULL BARREL (BUSHINGLESS) MODEL (EXCEPT OFFICER-STYLE)

WARNING: ALWAYS FOLLOW THE DISASSEMBLY AND REASSEMBLY INSTRUCTIONS EXACTLY. NEVER DO ANYTHING BEYOND WHAT YOU ARE SPECIFICALLY INSTRUCTED TO DO IN THIS MANUAL. NEVER ALTER OR MODIFY THE PARTS IN YOUR FIREARM.

WARNING: WEAR SAFETY GLASSES EVERY TIME YOU ASSEMBLE OR DISASSEMBLE YOUR FIREARM.

1. Assemble the guide rod, recoil spring, and plug as shown in Figure 40. In order to maintain proper pressure on the parts for assembly, insert the assembly back into the slide. Apply enough pressure to the back of the guide rod so that the hole in the plug is visible.
2. Insert the wire tool into the plug as shown in Figure 41. Remove the guide rod/recoil spring assembly.



3. Verify that the hammer is in the fully cocked position. Ensure that the barrel chamber is unloaded and nothing is in the bore of the barrel.

4. Turn the slide bottom up, ensure that the barrel link is in the forward position and place the barrel into the slide from the front. (See Figure 42.)

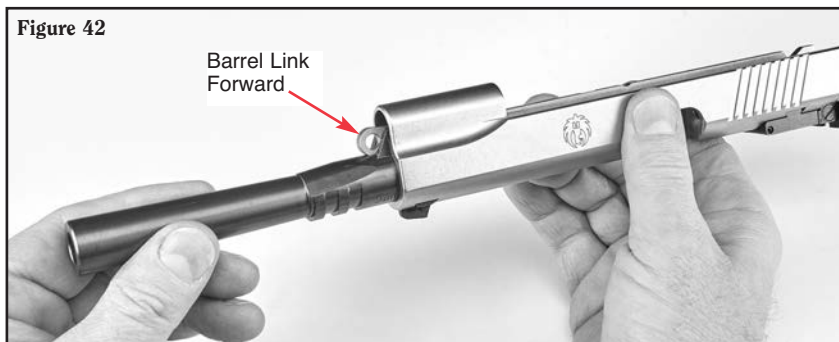

5. Flip the barrel link into the “up” position and carefully insert the guide rod/recoil spring assembly into the slide (see Figure 43b). Be sure that the curved areas of the guide rod/recoil spring assembly are lined up so that they lay on the barrel as you insert it into the slide (see Figure 43a).

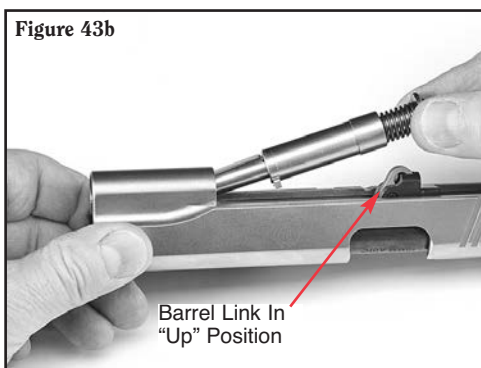
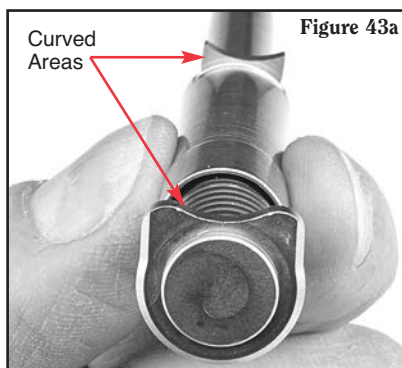

6. Align the slide with the rails on the frame and gently push the slide onto the frame as shown in Figure 44.



7. Move the slide and barrel rearward together until the barrel link hole is aligned with the slide stop hole. Insert the slide stop pin into the slide stop hole making sure it passes through the barrel link hole. (See Figure 45.) Align the takedown notch on the slide with the rectangular cutout of the frame. Push the slide stop pin all the way in so that its rearward tab passes through the takedown notch and is locked into place. (See Figure 46.)

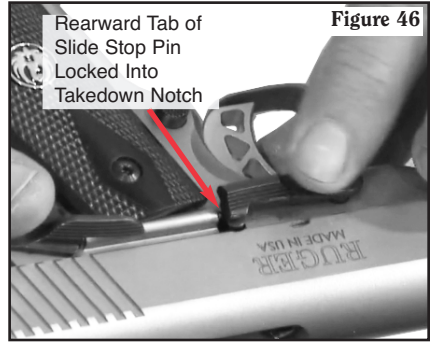
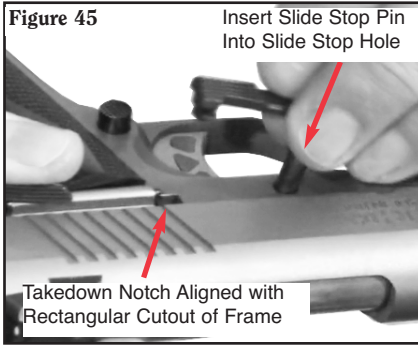

8. Pull the slide to the rear and lock open by pressing upward on the rear end of the slide stop. **Check the chamber and breech face to verify that the pistol is completely unloaded.**
9. Remove the wire tool from the hole in the guide rod/recoil spring assembly (see Figure 47).
10. Pull the slide rearward to release the slide stop and carefully allow the slide to move forward.

NOTE: Place the wire tool in a safe place for future use.

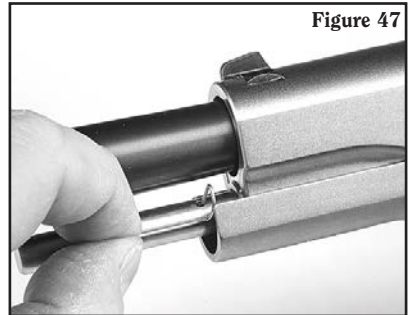

TO DISASSEMBLE: BULL BARREL (BUSHINGLESS) OFFICER-STYLE MODEL

Be sure firearm is unloaded!



WARNING: FOR ROUTINE MAINTENANCE, IT IS UNNECESSARY TO DISASSEMBLE THE FIREARM BEYOND WHAT IS DESCRIBED IN THESE INSTRUCTIONS. ANY FURTHER DISASSEMBLY SHOULD BE PERFORMED BY A LICENSED GUNSMITH.

WARNING: WEAR SAFETY GLASSES EVERY TIME YOU ASSEMBLE OR DISASSEMBLE YOUR FIREARM.

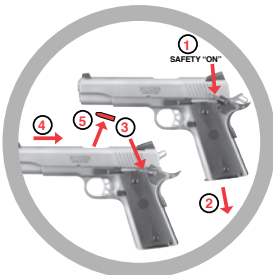
 WARNING - DISASSEMBLY	
	<p>Always unload a firearm before cleaning, lubrication, disassembly or assembly.</p>
UNLOAD BEFORE DISASSEMBLY	

1. Keep the pistol pointed in a safe direction and your fingers outside of the trigger guard. Press the magazine catch and withdraw the magazine from the magazine well of the pistol.
2. Pull the slide to the rear and lock it open by pressing upward on the rear end of the slide stop. Check the chamber and breech face to verify that the pistol is completely unloaded.

3. Pull the slide rearward to release the slide stop, then move the slide forward to align the takedown notch in the left side of the slide with the rear portion of the slide stop as shown in Figure 48.

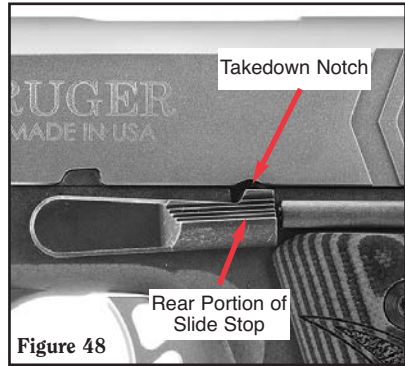

4. Press inward on the slide stop pin from the opposite side of the frame as shown in Figure 49a, and remove the slide stop (see Figure 49b).

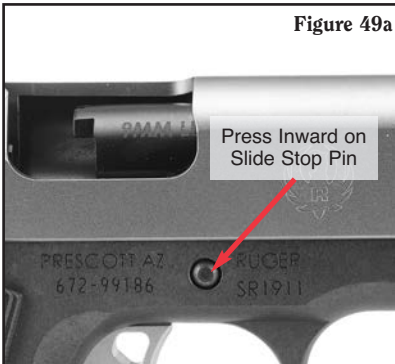

5. Move the slide forward off of the frame. (See Figure 50.)



6. Turn the slide bottom up and remove the guide rod/recoil spring assembly. To do this, move the guide rod assembly upwards (away from the barrel) then towards the rear of the slide. (See Figure 51.)

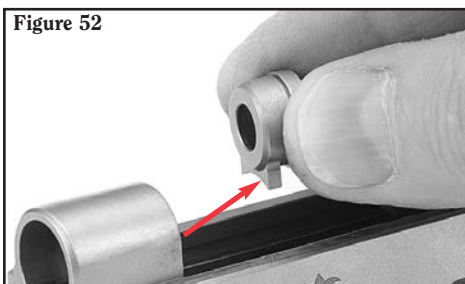
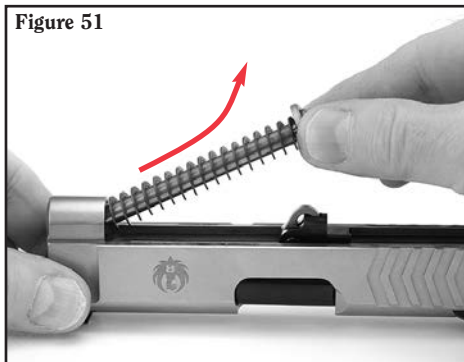

7. To remove the recoil spring plug, push it from the front and remove it from the rear. (See Figure 52.)

NOTE: You can also tilt the slide upward and allow the recoil spring plug to drop free.

8. Rotate the barrel link to the forward position (see Figure 53a) and remove the barrel through the front of the slide (see Figure 53b).



9. Figure 54 shows the parts you will have after field stripping.

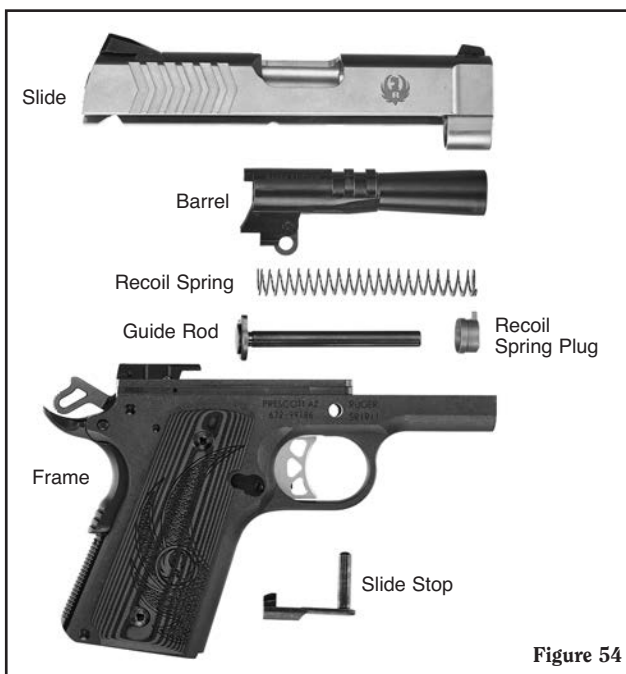

DO NOT DRY FIRE YOUR RUGER® SR1911® PISTOL WHILE THE SLIDE IS REMOVED. DOING SO CAN RESULT IN DAMAGE TO THE HAMMER OR OTHER INTERNAL PARTS.



DO NOT ALTER, MODIFY OR REPLACE ANY OF THE PARTS OF YOUR FIREARM UNLESS THE MODIFICATION IS PERFORMED BY A QUALIFIED GUNSMITH, USING GENUINE RUGER PARTS. IF YOU DO OTHERWISE, IMPROPER FUNCTION MAY OCCUR AND SERIOUS INJURY MAY RESULT.



NEVER DISASSEMBLE YOUR HANDGUN BEYOND THE FIELD STRIPPING PROCESS OUTLINED IN THIS MANUAL. NEVER MANIPULATE ANY INTERNAL COMPONENTS BEYOND WHAT YOU ARE SPECIFICALLY INSTRUCTED TO DO IN THIS MANUAL SINCE THIS MAY AFFECT THE RELIABILITY, FUNCTIONING AND SAFETY OF YOUR HANDGUN.



OTHER BRAND PARTS MUST NEVER BE USED IN YOUR RUGER® SR1911® EVEN THOUGH THE PARTS MAY APPEAR TO BE SIMILAR. USE OF ANY PARTS OTHER THAN GENUINE RUGER® SR1911® PARTS MAY CAUSE A SERIOUS MALFUNCTION RESULTING IN INJURY OR DEATH TO YOU OR OTHERS.

TO REASSEMBLE: BULL BARREL (BUSHINGLESS) OFFICER-STYLE MODEL

WARNING: ALWAYS FOLLOW THE DISASSEMBLY AND REASSEMBLY INSTRUCTIONS EXACTLY. NEVER DO ANYTHING BEYOND WHAT YOU ARE SPECIFICALLY INSTRUCTED TO DO IN THIS MANUAL. NEVER ALTER OR MODIFY THE PARTS IN YOUR FIREARM.

WARNING: WEAR SAFETY GLASSES EVERY TIME YOU ASSEMBLE OR DISASSEMBLE YOUR FIREARM.

1. Verify that the hammer is in the fully cocked position. Ensure that the barrel chamber is unloaded and nothing is in the bore of the barrel.
2. Turn the slide bottom up, ensure that the barrel link is in the forward position and place the barrel into the slide from the front. (See Figure 55.)

Figure 55

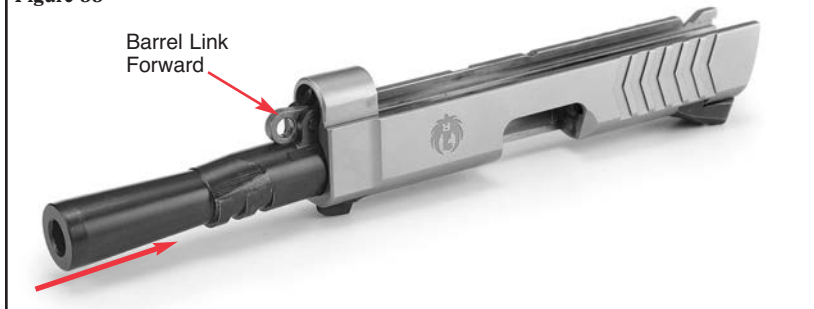

3. Flip the barrel link into the "up" position and install the recoil spring plug into the slide as shown in Figure 56.

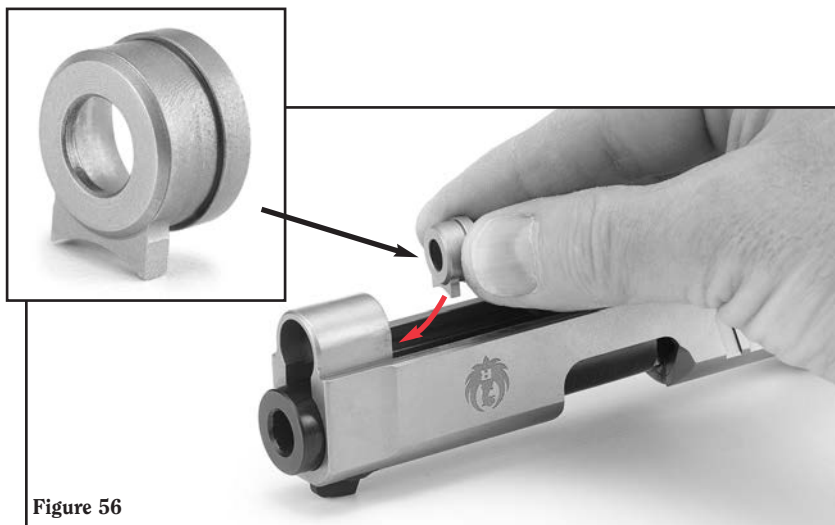
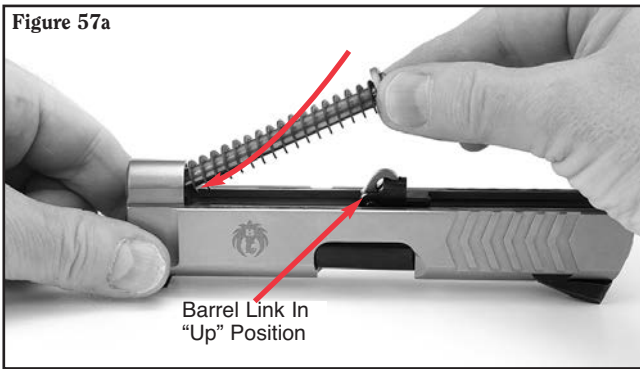

Figure 56

4. If it has been removed, install the recoil spring onto the guide rod. Carefully insert the guide rod/recoil spring assembly into the slide (see Figure 57a). Be sure that the curved areas of the guide rod/recoil spring assembly are lined up so that they lay on the barrel as you insert it into the slide (see Figure 57b).



5. Align the slide with the rails on the frame and gently push the slide onto the frame as shown in Figure 58.



6. Move the slide and barrel rearward together until the barrel link hole is aligned with the slide stop hole. Insert the slide stop pin into the slide stop hole making sure it passes through the barrel link hole. (See Figure 59.) Align the takedown notch on the slide with the rectangular cutout of the frame. Push the slide stop pin all the way in so that its rearward tab passes through the takedown notch and is locked into place. (See Figure 60.)

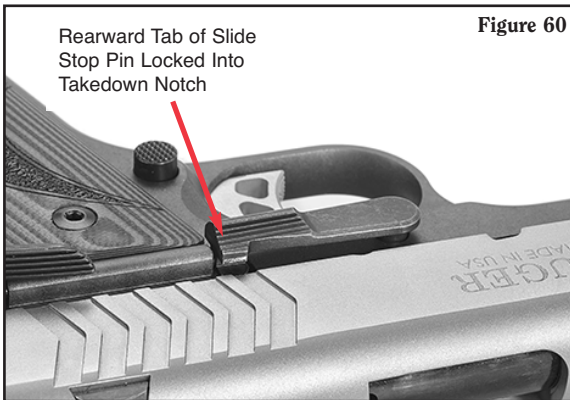
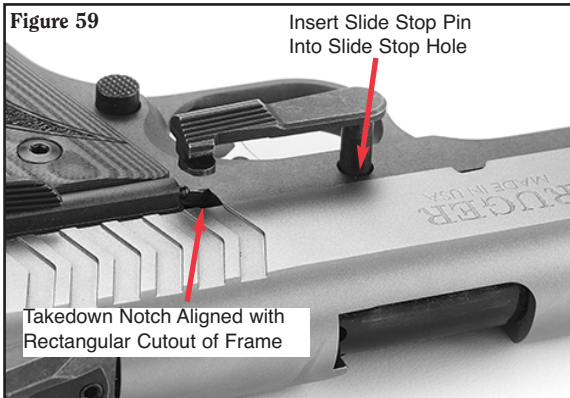

7. Pull the slide to the rear and lock open by pressing upward on the rear end of the slide stop. **Check the chamber and breech face to verify that the pistol is completely unloaded.**
8. Pull the slide rearward to release the slide stop and allow the slide to move forward.

NOTE: If the recoil spring plug is not fully inserted into the front of the slide, it will catch in the slide dust cover. Racking the slide and letting it slam forward will properly seat it.

MAGAZINE INSPECTION AND CARE

Check the magazine frequently. The magazine follower must move freely and have adequate tension so that each cartridge is quickly raised to the feeding position. The magazine lips should be clean and free of cracks, dents, or nicks, so that cartridges are held in their proper feeding position.

When cleaning is necessary, use a solvent that will not rust the metal components or adversely affect the magazine body. After the magazine has been soaked to loosen foreign matter, be certain to shake it vigorously (with the loading opening away from you) to remove solvent or residue from within the magazine. **Penetrating oils and solvents inside a magazine can “kill” or weaken cartridge primers or powder which can result in failures to fire or other possibly dangerous malfunctions, such as leaving a bullet in the bore!**

After cleaning, always check to be certain that the magazine follower movement and tension are correct, and that no solvent or debris remain. **If cleaning does not restore proper tension, or if you experience a problem with the magazine, don't use it. Get a new one.**

DAMAGED, NON-STANDARD, OR IMPROPERLY ASSEMBLED MAGAZINES SHOULD NOT BE USED. THEY CAN CAUSE THE PISTOL TO MALFUNCTION.

CARE AND CLEANING

Make Sure Firearm Is Unloaded!

BEFORE CLEANING, BE CERTAIN THE PISTOL AND ITS MAGAZINE ARE UNLOADED. (See “Warning - Unloading,” p. 21.)

At regular intervals, or whenever the pistol has been exposed to sand, dust, extreme humidity, condensation, immersion in water, or other adverse conditions, disassemble, clean, and oil it. Proper periodic maintenance is essential to the reliable functioning of any firearm.

An on-line video demonstrating the proper cleaning procedure of the **RUGER® SR1911®** can be viewed by going to **Ruger.com/TechTips**.

To clean the pistol, proceed as follows:

1. Disassemble (fieldstrip) the pistol to the extent described on pp. 25 - 28.

For the SR1911® pistols utilizing a bull barrel (bushingless) design (except Officer-Style bushingless model), follow the disassembly instructions on pp. 31 - 35.

For the Officer-Style SR1911® pistols utilizing a bull barrel (bushingless) design, follow the disassembly instructions on pp. 39 - 42.

2. Using a cleaning rod, run a properly sized, solvent-wetted patch through the bore several times. Then attach a solvent-wetted bristle brush to a cleaning rod and run it back and forth the full length of the bore as many times as necessary to remove grease and dirt from the bore and chamber. Clean bore with dry patches and examine. Bore fouling can contribute to reduced accuracy, and grease accumulation in the chamber can interfere with proper feeding of cartridges from the magazine.
3. Using powder solvent on a clean patch or bristle brush, remove powder residue from all components of the pistol. After cleaning, run a dry patch through the bore, then follow with a patch that is very lightly oiled. Wipe all surfaces clean with cloth, then wipe all surfaces with a patch or cloth that has been very lightly oiled.
4. **NOTE:** Your **RUGER® SR1911®** will ship from the factory properly lubricated. After cleaning, reapply a light oil or other firearms lubricant as described below. Be sure to remove excess lubricants. Excessive lubrication will attract dust and dirt and may congeal in cold weather, which can interfere with the safe and reliable function of the pistol.
 - a. Refer to the illustration in Figure 61 for slide lubrication points:

Spread a drop of lubricant along the side rails. **NOTE:** The lower protruding rail (not the groove in the slide) is the feature that rides on the frame.

Lubricate the recesses in the slide.

Lubricate the hammer cocking surface underneath the slide.

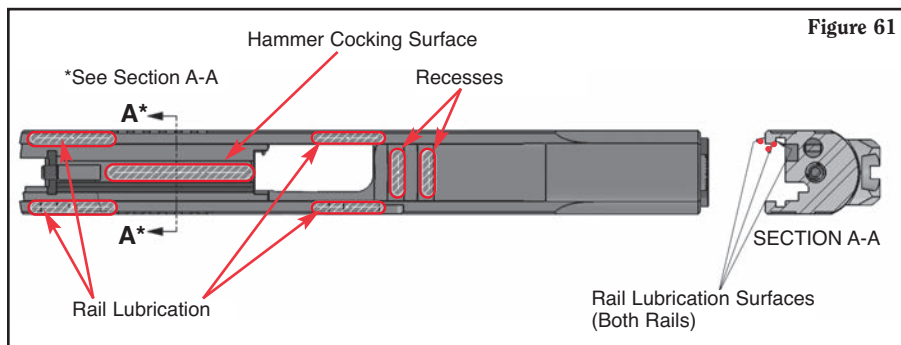

- b. For models with a barrel bushing, lubricate the barrel locating ridge inside the barrel bushing (where the barrel contacts the barrel bushing). See Figure 62.

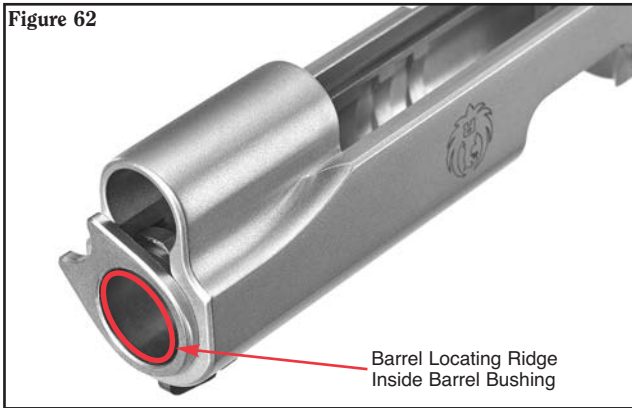

- c. Lubricate the disconnecter where it passes through the frame. **NOTE:** A light oil should be used here. See Figure 63.



5. Before firing, remove all oil and grease from the bore.

! WARNING - LUBRICATION	
	<p>Firing a pistol with oil, grease, or any other material even partially obstructing the bore may result in damage to the pistol and serious injury to the shooter and those nearby. Do not spray or apply lubricants directly on ammunition. If the powder of a cartridge is affected by the lubricant, it may not be ignited, but the primer firing may push the bullet into the bore where it may be lodged. Firing a subsequent bullet into the obstructed bore may damage the pistol and cause serious injury or death to the shooter and those nearby. Use lubricants properly. You are responsible for the proper care and maintenance of your firearms.</p>
IMPROPER LUBRICATION DESTROYS FIREARMS	

STORAGE

FIREARMS SHOULD NOT BE STORED LOADED!

USE THE LOCKING DEVICE SUPPLIED WITH THE PISTOL TO RENDER IT INOPERATIVE FOR SAFE STORAGE.

(SEE PAGE 9)

Do not keep your pistol in a leather, fabric or canvas holster when it is stored. These materials attract moisture, even though the holster may appear to be perfectly dry.

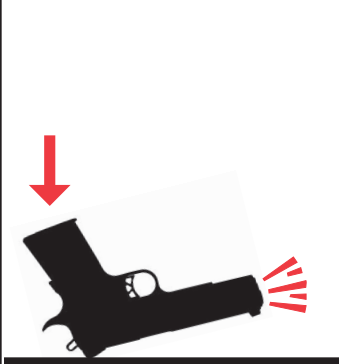
 WARNING – STORAGE	
	<ul style="list-style-type: none">• Never place or store any firearm in such a manner that it may be dislodged. Firearms should always be stored securely and unloaded, away from children and careless adults.• Use the locking device supplied with the pistol for storage. The use of a locking device or safety lock is only one aspect of responsible firearms storage.• For increased safety, firearms should be stored unloaded in a location that is both separate from their ammunition and inaccessible to children and any other unauthorized person.
STORE SECURELY & UNLOADED	

REAR SIGHT ADJUSTMENT

WARNING: ALWAYS ENSURE YOUR FIREARM IS UNLOADED BEFORE ADJUSTING YOUR SIGHTS. AT ALL TIMES YOU SHOULD FOLLOW THE BASIC RULES OF SAFE FIREARM HANDLING.

The **RUGER® SR1911®** Standard and Commander-Style pistols are equipped with a rear sight which is adjustable for windage only.

To adjust where the group prints, loosen the setscrew in the rear sight using a properly sized Allen Wrench. Move the rear sight in the direction you wish the group to move on the target. For example, if the group should move to the right, move the rear sight to the right. Once the sight is moved to the desired position, tighten the setscrew.

Target Model **RUGER® SR1911®** pistols are equipped with fully adjustable target sights: Turning the top (elevation) sight adjustment screw clockwise lowers the impact of the shot. Turning the horizontal (windage) sight adjustment screw clockwise moves the impact of the shot to the right.

SERVICE AND PARTS POLICY

If you have any questions with regard to the performance of your **RUGER® SR1911®** pistol contact our Customer Service online at **Ruger.com** or call the Customer Service Dept. at 336-949-5200. Fully describe all circumstances and conditions involved. If you should return your pistol to the factory for repair, or order parts for it, please comply with the following suggestions for prompt service:



WARNING—BEFORE SHIPPING ANY FIREARM, BE ABSOLUTELY CERTAIN THAT IT AND ITS MAGAZINE ARE UNLOADED. DO NOT SHIP CARTRIDGES WITH A FIREARM.

SHIPPING FIREARMS FOR REPAIR

NOTE: You must obtain a **Repair Authorization Number** before returning your **firearm**. An authorization number can be obtained by contacting Customer Service online at **Ruger.com** or calling the Customer Service Department at 336-949-5200. Firearms should be sent prepaid. We will not accept collect shipments. Any **RUGER® SR1911®** pistol returned to the factory for repair should be sent to: Sturm, Ruger & Company, Inc., Customer Service Department, 200 Ruger Road, Prescott, AZ 86301-6181.

The Federal Gun Control Act, as well as the laws of most states and localities, do not prohibit an individual (who is not otherwise barred from purchasing or possessing a firearm) from shipping a firearm directly to the manufacturer for repair. However, before you ship your firearm to us, be certain that your state or locality does not have a law or regulation which will prohibit you from receiving the firearm (or any included magazines) from us after it has been repaired. If such receipt is prohibited, please have a federally licensed firearms dealer ship the firearm to us. If your firearm is sent to us by a dealer, it will be returned to that dealer after being repaired. If a handgun (pistol or revolver) is shipped by an individual who does not hold a Federal Firearms License, it must be shipped for overnight delivery via U.P.S., Federal Express, or other, similar private overnight service. **NOTE:** Handguns may not be shipped via U.S. Mail. Persons who do not hold a Federal Firearms License are prohibited by Federal law from shipping a handgun by Mail. Handguns mailed in violation of the law may be impounded or confiscated by the Post Office and the non-FFL may be subject to prosecution.

Please do not include holsters, custom grip panels, or accessories with a firearm being shipped to the factory for service. **DO NOT SEND FIREARM BOXES OR LITERATURE THAT YOU CONSIDER TO BE COLLECTOR'S ITEMS – THESE ARE INVARIABLY DAMAGED OR DESTROYED IN SHIPMENT.** Always insure your shipment.

Enclose a letter which includes your name, address, telephone number, firearm serial number and model, and your repair authorization number. Describe in detail the trouble you have experienced with your firearm, or the work you wish to have done. Merely stating that the firearm “needs repair” is inadequate information. Please enclose copies of any previous correspondence.

All work performed is subject to a minimum labor charge and charges for shipping and handling. Most models can be reblued, but custom gunsmithing service or nonstandard alterations are NOT AVAILABLE from Ruger Customer Service Departments. Please contact the Customer Service Department for pricing information. In states that have a magazine capacity limitation, **DO NOT RETURN** so-called “high capacity” magazines as Ruger may not be able to return the magazine to you.

 WARNING – PARTS PURCHASERS	
	<ul style="list-style-type: none">• It is the purchaser’s responsibility to be absolutely certain that any parts ordered from the factory are correctly fitted and installed.• Firearms are complicated mechanisms and IMPROPER FITTING OF PARTS MAY RESULT IN A DANGEROUS MALFUNCTION, DAMAGE TO THE FIREARM, AND SERIOUS INJURY TO THE SHOOTER AND OTHER PERSONS.• The purchaser and installer of parts must accept full responsibility for the correct adjustment and functioning of the firearm after such installation.
PARTS MUST FIT CORRECTLY	

ORDERING PARTS

Please contact the Prescott, Arizona Customer Service Department for parts availability and current prices. All parts orders for the **RUGER® SR1911®** pistols should be sent to: Sturm, Ruger & Company, Inc., Customer Service Department, 200 Ruger Road, Prescott AZ 86301-6181, 336-949-5200. We cannot comply with open account or C.O.D. requests. Payment in full via credit card (Visa, MasterCard, or Discover only), money order or certified bank check (no personal checks or cash, please) is required before any service will be performed. Please provide your credit card number, your name as it appears on the credit card, the expiration date and the 3-digit security code. All parts orders are subject to a minimum charge and charges for shipping and handling. Order parts by **Part Name and specify the model and entire serial number** of the firearm for which the parts are being ordered. There is a minimum labor charge plus a shipping and handling charge if the parts are factory fit. All factory fit parts are fit on an exchange basis only. We will not return the replaced parts. Please contact the Customer Service Department for pricing information.

Because it is a serial numbered component, the **RUGER® SR1911®** frame is defined as a “firearm” by Federal law and is not sold as a separate component.

*Parts designated by an asterisk must be factory fit. These parts are fit on an exchange basis only. We will not return the replaced parts. We will not return any part that is broken, malfunctioning, badly worn or has been modified. See “Warning - Parts Purchasers,” above.



WARNING: A firearm containing broken, malfunctioning or badly worn parts should not be fired!

RUGER® SR1911®

PARTS LIST

Design, prices and specifications subject to change without notice.

SPECIFY MODEL, CALIBER, AND SERIAL NO. WHEN ORDERING

(See Exploded View on Page 53.)

Key No.	Part Name	Key No.	Part Name
* 1	Barrel Bushing (Does Not Apply to Bull Barrel Models)	25b	Ambidextrous Safety Lock, Right Side (Not Illustrated)
* 2	Slide	26	Disconnecter
* 3	Barrel	27	Sear
4	Barrel Link	28	Sear Pin
5	Barrel Link Pin	29	Slide Stop Plunger
6	Extractor	30	Plunger Spring
7	Recoil Spring	31	Safety Lock Plunger
8	Recoil Spring Guide	32	Ejector Pin
9	Recoil Spring Plug	33	Ejector
10	Firing Pin	34	Rear Sight
11	Firing Pin Stop	35	Rear Sight Set Screw
12	Firing Pin Spring	36	Front Sight
† 13	Frame	37	Mainspring Cap
14	Magazine Assembly, 8-rd	38	Mainspring
15	Magazine Catch	39	Mainspring Housing Pin Retainer
16	Magazine Catch Spring	40	Mainspring Cap Pin
17	Magazine Catch Lock	41	Mainspring Housing
18	Hammer	42	Mainspring Housing Pin
19	Hammer Strut	43	Sear Spring
20	Hammer Strut Pin	44	Grip Screw Bushing, 2 Req'd
21	Hammer Pin	45	Grip Screw, 2 Req'd
22	Grip Safety	46	Grips, Sold as Pair
23	Slide Stop	47	Barrel Bushing Wrench (Does Not Apply to Bull Barrel Models)
24	Trigger Assembly	48	Magazine Assembly, 7-rd
25a	Ambidextrous Safety Lock, Left Side		

* Parts so marked must be factory installed.

† The frame is defined as a “firearm” by Federal Law and is not sold as a separate component.

RUGER® SR1911® EXPLODED VIEW

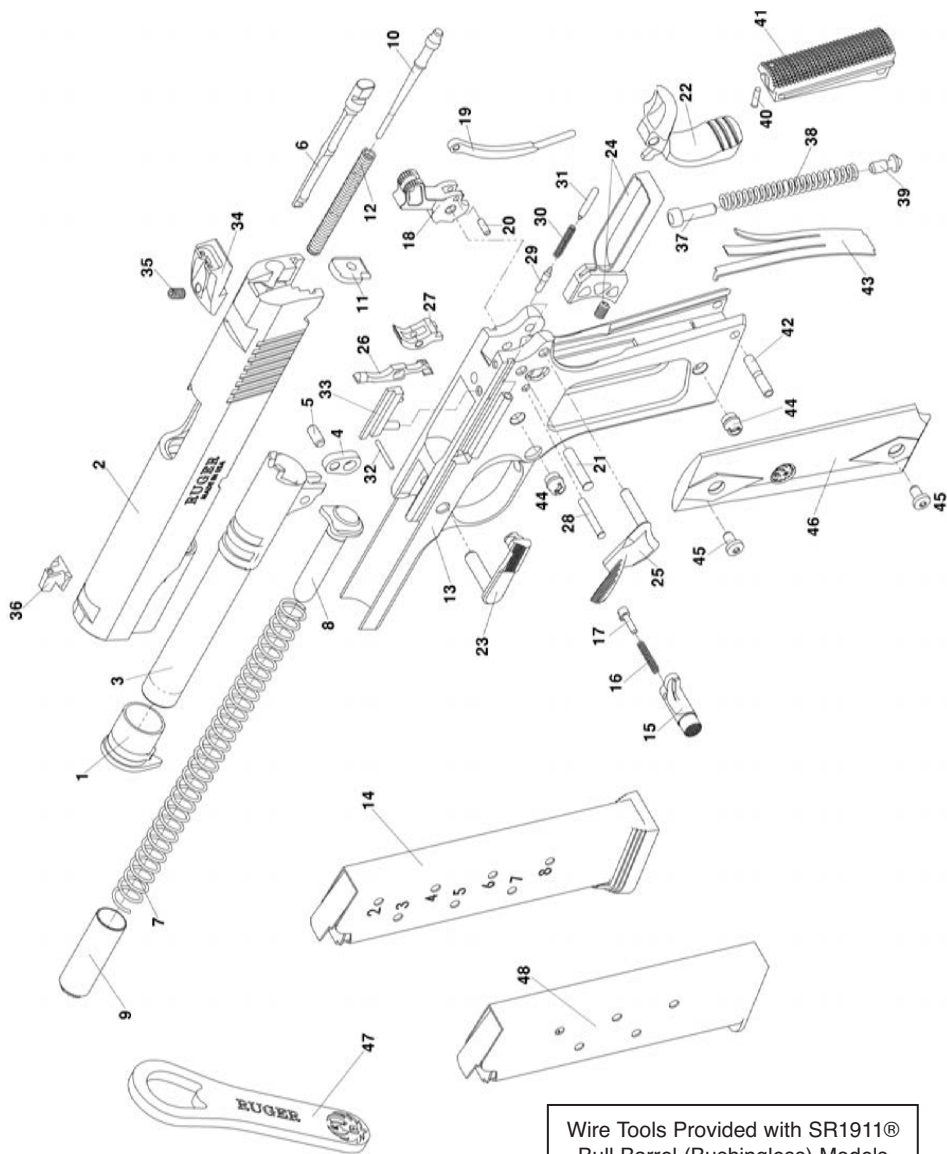

Wire Tools Provided with SR1911®
Bull Barrel (Bushingless) Models
(Except Officer-Style Model)



RUGER® OFFICER-STYLE SR1911®

SUPPLEMENTAL PARTS LIST & EXPLODED VIEW DRAWING

Please See Pages 52 - 53 For All Other Parts Lists and Exploded View Drawings

Key No.	Part Name
* 1	Slide
2	Recoil Spring
3	Guide Rod
4	Recoil Spring Plug

* Parts so marked must be factory installed.

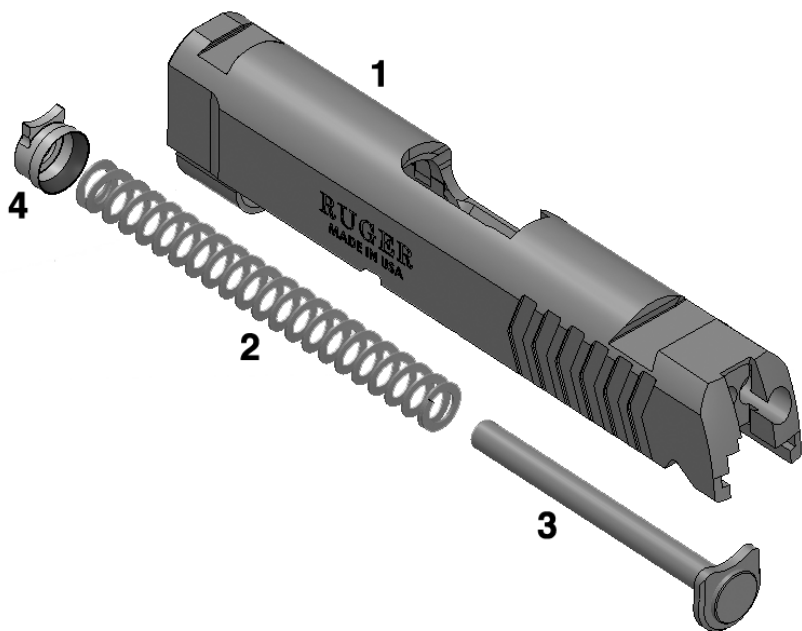

THE BASIC RULES OF SAFE FIREARMS HANDLING

We believe that Americans have a right to purchase and use firearms for lawful purposes. The private ownership of firearms in America is traditional, but that ownership imposes the responsibility on the gun owner to use his firearms in a way which will ensure his own safety and that of others. When firearms are used in a safe and responsible manner, they are a great source of pleasure and satisfaction, and represent a fundamental part of our personal liberty.

Firearms do not cause accidents! Firearms accidents are almost always found to have been the result of carelessness or ignorance on the part of the shooter of the basic rules of safe gun handling.

The following rules must be observed by gun users at all times. Safe gun handling is not just desirable, it is absolutely essential to your safety, the safety of others, and the continuation of gun ownership and sport shooting as we know it today.

1. LEARN THE MECHANICAL AND HANDLING CHARACTERISTICS OF THE FIREARM YOU ARE USING.



Not all firearms are the same. The method of carrying and handling firearms varies in accordance with the mechanical provisions for avoiding accidental discharge and the various proper procedures for loading and unloading. No person should handle any firearm without first having thoroughly familiarized himself with the particular type of firearms he is using, and with safe gun handling in general.

2. ALWAYS KEEP THE MUZZLE POINTED IN A SAFE DIRECTION.



Be sure of the bullet stop behind your target, even when dry-firing. Never let the muzzle of a firearm point at any part of your body or at another person. This is particularly important when loading or unloading a firearm. In the event of an accidental discharge, no injury can occur as long as the muzzle is pointing in safe direction. A safe direction means a direction that will not permit a discharged bullet to strike a person, or to strike an object from which the bullet may ricochet.

A safe direction must take into account the fact that a bullet may penetrate a wall, ceiling, floor, window, etc., and strike a person or damage property. Make it a habit to know exactly where the muzzle of your gun is pointing whenever you handle it, and be sure that you are always in control of the direction in which the muzzle is pointing, even if you fall or stumble. Keep your finger off the trigger until you are ready to shoot.

3. FIREARMS SHOULD BE UNLOADED WHEN NOT IN USE.

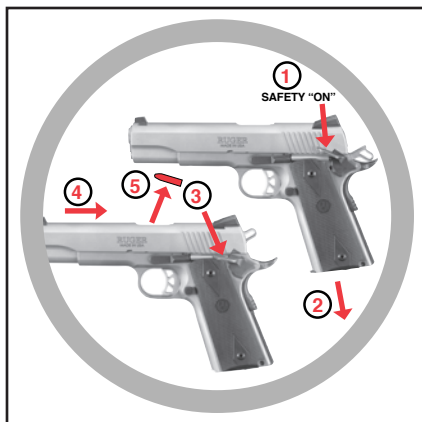

Firearms should be loaded only when you are in the field or on the target range or shooting area, ready to shoot. Firearms and ammunition should be securely locked in safes, racks or cabinets, or by using the locking device supplied with the firearm when not in use. Ammunition should be safely stored separate from firearms. Store your firearms out of sight of visitors and children. It is the gun owner's responsibility to be certain that children and persons unfamiliar with firearms cannot gain access to firearms, ammunition, or components.

4. BE SURE THE BARREL IS CLEAR OF OBSTRUCTIONS BEFORE SHOOTING.

Even a bit of mud, snow or excess lubricating oil or grease in the bore may cause the barrel to bulge, or even burst on firing, and can cause injury to the shooter and bystanders. Be sure that you are using ammunition of the proper caliber and loading for the gun you are using. If the report or recoil on firing seems weak, or doesn't seem quite right, CEASE FIRING IMMEDIATELY, unload your firearm, and check to be sure that no obstruction has become lodged in the barrel. Never try to shoot an obstruction out!





5. BE SURE OF YOUR TARGET BEFORE YOU SHOOT.

Don't shoot unless you know exactly where your bullet is going to strike. Be sure of the bullet stop behind your target, even when dry-firing with an unloaded gun. If you are in the field hunting, do not fire at a movement or noise. Take the time to be absolutely certain of your target before you pull the trigger.

6. WEAR SHOOTING GLASSES AND HEARING PROTECTION WHEN YOU SHOOT.

All shooters should wear protective shooting glasses and adequate hearing protection when shooting. Exposure to shooting noise can damage hearing, and wearing adequate eye protection when shooting is essential.



7. NEVER CLIMB A TREE OR FENCE WITH A LOADED FIREARM.

Put the firearm down carefully before climbing a fence, and unload it before climbing or descending a tree or jumping over a ditch or other obstruction. Never pull or push a loaded firearm toward yourself or another person. When in doubt, or whenever you are about to do anything awkward, unload your gun!

8. DON'T SHOOT AT A HARD SURFACE OR AT WATER.

Bullets can glance off many surfaces like rocks or the surface of water and travel in unpredictable directions with considerable velocity.



9. NEVER TRANSPORT A LOADED FIREARM.

Firearms should always be unloaded before being moved or placed in a vehicle. A suitable carrying case or scabbard should be used to carry an unloaded firearm to and from the shooting area.

10. AVOID ALCOHOLIC BEVERAGES WHEN SHOOTING.

Don't drink until the day's shooting is over. Handling firearms while under the influence of alcohol in any form, or medications that could affect your judgement or coordination, constitutes a criminal disregard for the safety of others.



A BRIEF ACCOUNT OF AN EXTRAORDINARY ACHIEVEMENT: RUGER® FIREARMS

Sturm, Ruger & Company, Inc., had its beginning in a small machine shop occupying a rented frame building in Southport, Connecticut. In January, 1949, with an initial investment of only \$50,000 and an idea, William B. Ruger and Alexander M. Sturm started production of a .22 caliber autoloading pistol—a design which was so successful that it became the cornerstone upon which one of the most comprehensive lines of sporting firearms ever made in America was established. After Alex Sturm's death in 1951, William B. Ruger continued to direct the Company until his death in 2002. William B. Ruger, Jr. continued to provide guidance, which helped make this Company a sound and successful enterprise, until his retirement in 2006. The Company has continued to prosper, under new management and guidance from our Board, with new products and fresh perspectives.

Ruger, in this relatively short time, has established itself as a leading small arms design organization, developing a unique and broad line of fine quality sporting, military and police firearms to become one of the world's most famous producers of revolvers, pistols, rifles and shotguns. Since 1949, Ruger craftsmen have built many millions of firearms.

During its five decades of growth and progress under the leadership of William B. Ruger, the Company developed a business philosophy and implemented policies which represent a constructive influence in the life of modern America. From the beginning, Ruger played a positive role in conservation efforts and has supported the interests of shooters through such groups as the National Rifle Association, National Shooting Sports Foundation, and many regional sportsmen's organizations.

The Company has always endeavored to market its firearms for constructive and recreational purposes, to emphasize the traditional and responsible aspects of shooting, to render meaningful public services, and to encourage shooters in constructive, responsible, and safe participation in the shooting sports. Its motto, "Arms Makers For Responsible Citizens®," exemplifies this Company philosophy.

Today, Ruger® is particularly mindful of those elements which have contributed to the creation of its success, and extends heartfelt thanks to its many loyal employees and customers.

The firearms catalog, and instruction manuals for all Ruger® firearms, can be downloaded from our website at:

Ruger.com

WHY NO WARRANTY CARD HAS BEEN PACKED WITH THIS NEW RUGER® FIREARM

The Magnuson-Moss Act (Public Law 93-637) does not require any seller or manufacturer of a consumer product to give a written warranty. It does provide that if a written warranty is given, it must be designated as "limited" or as "full" and sets minimum standards for a "full" warranty. Sturm, Ruger & Company, Inc. has elected not to provide any written warranty, either "limited" or "full", rather than to attempt to comply with the provisions of the Magnuson-Moss Act and the regulations issued thereunder. There are certain implied warranties under state law with respect to sales of consumer goods. As the extent and interpretation of these implied warranties varies from state to state, you should refer to your state statutes. Sturm, Ruger & Company wishes to assure its customers of its continued interest in providing service to owners of Ruger® firearms.



STURM, RUGER & COMPANY, INC.

200 Ruger Road

Prescott, Arizona 86301 U.S.A.

Ruger.com

Arms Makers For Responsible Citizens®

**A COPY OF THE INSTRUCTION MANUAL FOR ANY RUGER®
FIREARM IS AVAILABLE FROM THE FACTORY FREE ON REQUEST, OR IT MAY BE
DOWNLOADED FROM OUR WEBSITE AT RUGER.COM.
THESE INSTRUCTION MANUALS CONTAIN IMPORTANT
WARNINGS WHICH MUST BE UNDERSTOOD
BEFORE USING THESE FIREARMS.**

The Following are Sturm, Ruger & Co., Inc. Trademarks: "BX-Trigger," "Bisley," Eagle Hard "R" logo holding gun, "Elite 452," "Gold Label," "I'm a Ruger American," "LC6," "LCR-357," "LC380CA," "Mark II," "Mark III," "Model 96," "P345," "P345D," "P345PR," "P85," "P90," "P91," "P93," "P94," "P95," "P97," "R.I.O.S.," "Ruger-57," "Ruger Marksman Adjustable," "Ruger 77/50," "Ruger 10/17," "Ruger Titanium," "Security-Six," "Service-Six," "77/357," "Single-Seven," "Speed-Six," "SR45," "SR-556C," "SR-556VT," "SR-762," "Super Bearcat," "Target Grey," "10/22-FS," "This is Ruger. This is America.," "Tri-Flex," "22 Charger," "22/45," and "22/45 RP."

The Following are Registered U.S. Trademarks Belonging to Sturm, Ruger & Co., Inc.: "AC-556," "AR-556," "Arms Makers For Responsible Citizens," "All-Weather," "Bearcat," "Blackhawk," "BX-15," "BX-25," Eagle 'R' - soft 'R' & hard 'R', Eagle 'SR', "EC9s," "Everything you need and nothing you don't.," "GP100," "Hawkeye," "It's Mine and It's American," "It's Mine. And It's American," "LC380," "LC9," "LC9s," "LC9s Pro," "LCP," "LCR," "LCRx," "M77," "Match Champion," "Mini Thirty," "Mini-14," "9E," "Old Army," "Power Bedding," "Redhawk," "RUGER," "Ruger American Pistol," "Ruger American Pistol" flag design, "Ruger American," "Ruger American Rifle," "Ruger American Rimfire," "Ruger Custom Shop," "Ruger Hunting" - phrase & logo design, "Ruger Inside & Out" - phrase & logo design, "Ruger Precision," "Ruger Precision Rifle," "Ruger 77/17," "Ruger 77/22," "Ruger 77/44," "Ruger SP101," "Ruger 10/22 Takedown" phrase & logo design, "Ruger 22/45 Lite," "Ruger Vaquero," "Rugged, Reliable Firearms," "Security-9," "Silent-SR," "Single-Nine," "Single-Six," "Single-Ten," the "SR" Design, "SR9," "SR9c," "SR40," "SR40c," "SR-22," "SR22," "SR-556," "SR-556 Takedown," "SR1911," "Super Redhawk Alaskan," "10/22," "10/22 Takedown," and "Wrangler."