



**FN FIVE-SEVEN<sup>®</sup>**  
**Series**

....

**AUTOLOADING PISTOL  
OWNER'S MANUAL**

Important operating instructions for:

# **FN FIVE-SEVEN® AUTOLOADING PISTOL OWNER'S MANUAL**

If you have any questions or comments regarding your new firearm, please contact us:

FN Service Center (800) 635-1321  
797 Old Clemson Road customerservice@fnamerica.com  
Columbia, SC 2922 www.fnamerica.com

Please use the space below to record information about your new firearm.

Model: \_\_\_\_\_

Serial Number: \_\_\_\_\_

Purchased From: \_\_\_\_\_

Date of Purchase: \_\_\_\_\_

© 2021 FN America, LLC All Rights Reserved.

## **CONTENTS PAGE**

<b>1. Safety Information...</b>	<b>6</b>
<b>2. Technical Information...</b>	<b>18</b>
2.1. Nomenclature...	18
2.2. Functioning...	19
2.3. Magazines and ammunition...	23
<b>3. Contents of the Storage Box...</b>	<b>26</b>
<b>4. Using the Pistol...</b>	<b>27</b>
4.1. Safety checks...	27
4.2. Rear sight adjustment...	30
4.3. Loading the magazine...	31
4.4. Loading the pistol...	33
4.5. Firing...	34
4.6. Reloading during firing...	36
4.7. Unloading the pistol...	38
4.8. Decocking the hammer...	38
<b>5. Optics Mounting System...</b>	<b>38</b>
5.1. Installing an optic...	39
5.2. Removing an optic...	40
5.3. Mounting system chart...	41
<b>6. Maintenance...</b>	<b>43</b>
6.1. Disassembling and reassembling the pistol...	43
6.2. Disassembling and reassembling the magazine...	46
6.3. Reversing the magazine catch...	47
6.4. Cleaning and lubrication...	49
6.5. Additional care...	53
<b>7. Additional Information...</b>	<b>54</b>
<b>8. Warranty, Service and Technical Questions...</b>	<b>55</b>
<b>9. Technical Specifications...</b>	<b>59</b>

## CAUTION

*This manual has been written exclusively for the FN Five-seveN® MRD pistols.*

*If your FN Five-seveN® MRD pistol has an inscription other than “cal. 5.7x28” on its right side or on the rear right end of the barrel (visible through the ejection port) or if the external appearance of the pistol does not correspond to the illustrations of this manual, please contact the FN Service Center or your departmental armorer to obtain the Owner’s Manual that has been written specifically for your pistol.*

*If you have any questions or comments regarding your new firearm, please contact us.*

*FN Service Center, (800) 635-1321, fnamerica.com.*

*(\* ) The serial number of your pistol is engraved in the right side of the frame, just above the accessory rail.*

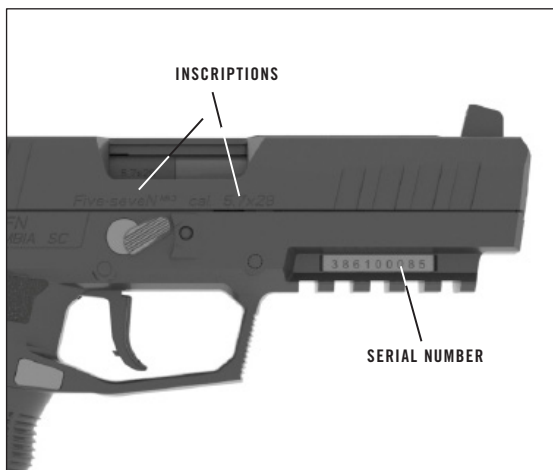

## FOREWORD

The FN Five-seveN® MRD is an autoloading, single-action pistol which represents the highest level of reliability, consistent performance and functional design and which provides the operating precision and safety expected from a sporting handgun.

The pistol, which exhibits the latest technical evolutions in weapon design for military, law enforcement and sporting use, has been conceived based on the experience of a collective team of experts in every field related to autoloading pistols.

Simple in design, this pistol is very easy to maintain: with a reasonable amount of care, your FN Five-seveN® MRD should give you many years of dependable, enjoyable service.

To take maximum advantage of the many features of your FN Five-seveN® MRD, regularly review this Owner’s Manual which should be kept in the slot especially provided in the storage box of the pistol.

Please feel free to contact us if you have any observations or questions regarding the performance or the operation of your pistol.

**FN FIVE-SEVEN® MRD**



## SAFETY AND WARRANTY NOTES

Like all firearms, the FN Five-seveN® MRD, if handled in a careless or reckless manner, can be very dangerous.

For that reason, the pistol is sold under the express understanding that FN HERSTAL and FN AMERICA, LLC decline any responsibility and invalidate any guarantee and liability claims for incidental or consequential damages (injuries, loss of use of property, commercial loss, loss of earnings and profits, ...) resulting in whole or partly from:

- the use of reloaded ammunition
- a discharge with criminal intent or through negligence
- improper or careless handling
- unauthorized servicing
- the modification or the alteration of the basic pistol design
- the use of non-original parts
- the alteration of the safety devices
- the use of incorrect “arms & ammunition” combinations
- the use of defective, damaged, unsafe, ... ammunition
- inadequate care of the pistol (e.g. corrosion, damage)
- a disregard of malfunctions
- a resale in contradiction to legislation
- other circumstances beyond our direct and immediate control

FN HERSTAL and FN AMERICA, LLC reserve the right to refuse servicing a pistol which has been modified (removal of metal from the barrel, modifications of the operating system and/or other parts, ...) and will, in such a case, always recommend to restore the pistol to its original specifications, as long as it is lawful to do so. Parts and labor required for such a restoration are payable by the owner of the pistol.

## SAFETY INFORMATION

### **⚠WARNING**

#### **FAILURE TO FOLLOW ANY OF THE FOLLOWING WARNINGS COULD RESULT IN SERIOUS INJURY OR DEATH.**

As a firearm owner, you accept a set of demanding responsibilities.

How seriously you take these responsibilities can be the difference between life and death.

There is no excuse for careless or abusive handling of any firearm.

At all times, handle this firearm and all other firearms with intense respect for their power and potential danger.

Please read and understand all the cautions, warnings, notices, proper handling procedures and instructions outlined in this Owner's Manual before using your new firearm.

#### **1. ALWAYS KEEP THE MUZZLE OF YOUR FIREARM POINTED IN A SAFE DIRECTION EVEN THOUGH YOU ARE CERTAIN THAT IT IS UNLOADED.**

Never point any firearm at anything you do not intend to shoot.

Be extremely alert and aware of all persons and property within the range of your ammunition.

**2. NEVER RELY TOTALLY ON YOUR FIREARM'S MECHANICAL "SAFETY" DEVICES. LIKE ANY MECHANICAL DEVICE, A "SAFETY" CAN SOMETIMES FAIL; IT CAN BE JARRED OR INADVERTENTLY MANIPULATED INTO AN UNSAFE CONDITION.**

The word "safety" describes a firearm's trigger block mechanism, sear block mechanism, hammer block mechanism or firing pin block mechanism.

Mechanical "safeties" are designed to place your firearm in a safer status, and no guarantee can be made that the firearm will not fire, even if the "safety" is at the "safe" position. Mechanical "safeties" merely aid safe gun handling and are no excuse for pointing your firearm's muzzle in an unsafe direction. For more information about the operation of this firearm's "manual safety", refer to § 2.2.

Remember, safe gun handling does not stop with your firearm's mechanical "safety" devices, it starts there. Always treat this firearm with the respect due to a loaded, ready-to-fire firearm.

Some firearms do not have a mechanical "safety." Many target firearms, lever-action firearms and pistols do not have manual "safety" mechanisms. Therefore it is critical to read and understand the Owner's Manual for every firearm to be informed about the safe operation of the firearm.

While it is a good idea to test your firearm's mechanical "safety" periodically for proper function, never test it while your firearm is loaded or pointed in an unsafe direction.

**3. NEVER RELY TOTALLY ON YOUR FIREARM'S MECHANICAL "SAFETY" DEVICES. LIKE ANY MECHANICAL DEVICE, A "SAFETY" CAN SOMETIMES FAIL; IT CAN BE JARRED OR INADVERTENTLY MANIPULATED INTO AN UNSAFE CONDITION.**

The word "safety" describes a firearm's trigger block mechanism, sear block mechanism, hammer block mechanism or firing pin block mechanism.

Mechanical "safeties" are designed to place your firearm in a safer status, and no guarantee can be made that the firearm will not fire, even if the "safety" is at the "safe" position. Mechanical "safeties" merely aid safe gun handling and are no excuse for pointing your firearm's muzzle in an unsafe direction. For more information about the operation of this firearm's "manual safety," refer to § 2.2.

Remember, safe gun handling does not stop with your firearm's mechanical "safety" devices, it starts there. Always treat this firearm with the respect due to a loaded, ready-to-fire firearm.

Some firearms do not have a mechanical "safety." Many target firearms, lever-action firearms and pistols do not have manual "safety" mechanisms. Therefore it is critical to read and understand the Owner's Manual for every firearm to be informed about the safe operation of the firearm.

While it is a good idea to test your firearm's mechanical "safety" periodically for proper function, never test it while your firearm is loaded or pointed in an unsafe direction.

**4. WHENEVER YOU HANDLE ANY FIREARM, OR HAND IT TO SOMEONE, ALWAYS ENSURE THAT THE FIREARM IS COMPLETELY UNLOADED.**

Carry out the safety checks as described in § 4.1.

Ensure that the firearm does not inadvertently contain any ammunition.

Always keep the chamber empty and the manual safety at the “safe” position, unless shooting is imminent.

**5. ALWAYS WEAR HEARING AND EYE PROTECTION WHEN SHOOTING.**

Unprotected, repeated exposure to gunfire can cause hearing damage. Wear ear protectors (shooting earplugs or muffs) to guard against such damage.

Wear shooting glasses to protect your eyes from flying particles. Allow proper distance (eye relief) between the rear sight of the pistol and your eye when shooting.

Do not use unorthodox shooting methods that could cause the rearward travel of the slide of your firearm to contact your eyes, face or hands.

Always keep a safe distance between the muzzle of your firearm and any persons nearby, as muzzle blast, debris and ejecting shells could inflict serious injury.

Always wear eye protection when disassembling and cleaning your pistol to prevent the possibility of springs, spring-tensioned parts, solvents or other agents from contacting your eyes.

**6. KEEP ALL FIREARMS UNLOADED DURING TRANSPORT, EVEN WHEN STORED IN A HOLSTER, A GUN CASE OR ANOTHER CONTAINER.**

For law enforcement and military personnel, refer to the procedures of your department on carrying a loaded firearm.

**7. DROPPING OR JARRING A LOADED FIREARM CAN CAUSE AN ACCIDENTAL DISCHARGE.**

This can occur even with the manual safety at the “safe” position or with the hammer in the decocked position. Be extremely careful while hunting or during any shooting activity, to avoid dropping any firearm.

**8. SHOOTING FROM ELEVATED SURFACES IS DANGEROUS.**

Doing so may increase the risk of incorrect handling a firearm.

The following rules should always be observed:

Always ensure that the surface being used is safe and stable.

Always ensure that your firearm is unloaded when it is being taken up and down from the surface.

Always ensure that your firearm is not dropped from the surface, or dropped while it is being taken up or down from the surface.

Remember, your loaded firearm may discharge when dropped, even with the manual safety at the “safe” position or with the hammer not cocked.

**9. STORE YOUR FIREARM AND AMMUNITION SEPARATELY, WELL BEYOND THE REACH OF CHILDREN.**

Take prudent safeguards to ensure that your firearm does not become available to untrained, inexperienced or unwelcome hands.

Store all firearms in secure, locked cases or in a gun safe.

Keep your firearm unloaded when not in use.

At all times, comply with the local and state laws.

For law enforcement and military personnel, refer to the procedures of your department on storing your firearm.

**10. BEWARE OF BARREL OBSTRUCTIONS.**

Mud, snow and an infinite variety of other objects may inadvertently lodge in the bore of a barrel. It only takes a small obstruction to cause dangerously increased pressures which can damage your firearm and cause serious injury to yourself and others.

**11. BEFORE CHECKING FOR A BARREL OBSTRUCTION, ENSURE THAT YOUR FIREARM IS COMPLETELY UNLOADED, THAT THERE IS NO ROUND IN THE CHAMBER AND THAT THE MANUAL SAFETY IS AT THE "SAFE" POSITION.**

Carry out the safety checks as described in § 4.1. After having ensured that the firearm is completely unloaded, pull the slide completely rearwards and look through the barrel to ensure that it is clear of any obstruction. If an obstruction is seen, no matter how small it may be, clean the bore of the barrel as described in § 6.4.1.

**12. BE ALERT TO THE SIGNS OF AMMUNITION MALFUNCTION. IF YOU DETECT AN OFF SOUND OR A LIGHT RECOIL WHEN A ROUND IS FIRED, DO NOT LOAD ANOTHER ROUND INTO THE CHAMBER.**

If your firearm fails to fire, keep the muzzle pointed in a safe direction for a minimum of 30 seconds. Carefully pull the slide completely rearward to remove the round from the chamber and then carry out the safety checks as described in § 4.1.

If the primer is indented, the defective round should be disposed of in a way that cannot cause harm. If the primer is not indented, your firearm should be examined by the FN Service Center or your departmental armorer and the cause of the malfunction should be corrected before further use.

With the slide open, glance down the barrel to ensure that there is no obstruction in the barrel. If there is an obstruction, completely clear the barrel before loading and firing again.

Failure to follow these instructions can cause extensive damage to your firearm and possible serious injury to yourself and others.

**13. NEVER INSERT A ROUND OF THE INCORRECT CALIBER INTO ANY FIREARM.**

The caliber of your firearm is marked on the right side of the slide and on the rear right end of the barrel. Store rounds of different calibers in completely separate and well-marked containers.

Never store rounds of mixed calibers in a common container or in your pockets.

For more information about the correct ammunition for your firearm, refer to § 2.3.2.

**14. EXAMINE EVERY ROUND YOU PUT IN YOUR FIREARM.**

We assume no responsibility for the use of unsafe or improper firearm and ammunition combinations or damage or injury caused by damaged ammunition.

It is your responsibility to read and heed all the warnings in this Owner's Manual and on the ammunition boxes.

For more information about the correct ammunition for your firearm, refer to § 2.3.2.

**15. USE THE PROPER AMMUNITION.**

The barrel and the slide of your firearm have been made with substantial safety margins with regard to the pressures developed by the 5.7x28mm ammunition designed by FN HERSTAL.

However, FN HERSTAL and FN AMERICA, LLC assume no liability for accidents which occur through the use of reloaded ammunition or 5.7x28mm rounds not fabricated according to the FN HERSTAL standards.

**16. USE ONLY SPECIALLY COATED FACTORY LOADED AMMUNITION.**

The use of any non-factory loaded and coated ammunition can result in pressures leading to personal injury as well as to damage to the pistol.

**17. MAKE SURE OF ADEQUATE VENTILATION IN THE AREA IN WHICH YOU DISCHARGE A FIREARM. LEAD EXPOSURE CAN OCCUR FROM DISCHARGING FIREARMS IN POORLY VENTILATED AREAS, FROM CLEANING FIREARMS OR FROM HANDLING AMMUNITION.**

Lead is a substance that has been known to cause birth defects, reproductive harm and other serious injury.

Wash your hands thoroughly after exposure to ammunition or after having cleaned a firearm.

**18. DO NOT SNAP THE FIRING PIN ON AN EMPTY CHAMBER: THE CHAMBER MAY NOT BE EMPTY!**

Treat every firearm with the respect due to a loaded firearm, even though you are certain that the firearm is unloaded.

**19. KEEP YOUR FINGERS AWAY FROM THE TRIGGER WHILE UNLOADING, LOADING AND REMOVING THE MAGAZINE.**

Only touch the trigger when you are ready to shoot or when decocking the hammer as described in § 4.1.

**20. ALWAYS UNLOAD YOUR FIREARM'S CHAMBER BEFORE CROSSING A FENCE, CLIMBING A TREE, JUMPING A DITCH OR NEGOTIATING OTHER OBSTACLES.**

Never place your firearm on a fence, a tree, a car or any unstable object.

For law enforcement and military personnel, refer to the procedures of your department.



**21. BE SURE OF YOUR TARGET AND BACKSTOP, PARTICULARLY DURING LOW LIGHT PERIODS.**

Know the range of your ammunition.

Never shoot at water or at hard objects.

**22. BE DEFENSIVE AND ON GUARD AGAINST UNSAFE GUN HANDLING AROUND YOU AND OTHERS.**

Do not be timid when it comes to gun safety. If you observe other shooters violating any of these safety precautions, politely suggest safer handling practices.

**23. BE CERTAIN YOUR FIREARM IS UNLOADED BEFORE CLEANING.**

Because so many gun accidents occur when a firearm is being cleaned, special and extreme care should be taken to ensure that your firearm is unloaded before disassembly, cleaning and reassembly.

Keep ammunition away from the cleaning location.

Never test the mechanical function of any firearm with live ammunition.

**24. TEACH AND SUPERVISE FIREARMS SAFETY TO ALL THE MEMBERS OF YOUR FAMILY, ESPECIALLY TO CHILDREN AND NON-SHOOTERS.**

Closely supervise newcomers to the shooting sports.

Encourage enrollment in hunting and shooting safety courses.

**25. READ AND HEED ALL WARNINGS IN THIS OWNER'S MANUAL, ON THE AMMUNITION BOXES AND WITH ALL THE ACCESSORIES THAT YOU INSTALL ON YOUR FIREARM.**

**26. IT IS YOUR RESPONSIBILITY TO SECURE THE MOST UP-TO-DATE INFORMATION ON THE SAFE HANDLING PROCEDURES FOR YOUR FN FIREARM.**

**27. FN HERSTAL AND FN AMERICA, LLC ASSUME NO LIABILITY FOR INCIDENTS WHICH OCCUR WHEN UNSAFE OR IMPROPER PISTOL ACCESSORIES OR AMMUNITION COMBINATIONS ARE USED.**

**28. NEVER DRINK ALCOHOLIC BEVERAGES OR TAKE ANY TYPE OF DRUG BEFORE OR DURING SHOOTING.**

Your vision, motor skills and judgment could be dangerously impaired, making your gun handling unsafe to you and to others.

**29. PRACTICE PERIODIC MAINTENANCE, AVOID UNAUTHORIZED SERVICING.**

Your firearm is a mechanical device which will not last forever, and as such, is subject to wear and requires periodic inspection, adjustment and service.

FN firearms should be serviced by the FN Service Center in Columbia, South Carolina.

FN HERSTAL and FN AMERICA, LLC cannot assume any responsibility for injuries suffered or caused by unauthorized servicing, alterations or modifications of FN firearms.

**30. FN HERSTAL AND FN AMERICA, LLC RESERVE THE RIGHT TO REFUSE SERVICE ON FIREARMS THAT HAVE BEEN ALTERED, ADDED TO OR SUBSTANTIALLY CHANGED.**

Removal of metal from the barrel or modifications of the firing mechanism and/or operating parts may lead to a refusal of service on such firearms. FN will charge the owner for parts and labor to return the firearm to original FN specifications.

**31. DO NOT, UNDER ANY CIRCUMSTANCE, ALTER THE TRIGGER, THE SAFETY OR OTHER PARTS OF THE FIRING MECHANISM OF THIS OR ANY OTHER FIREARM.**

**FAILURE TO OBEY THIS WARNING MAY RESULT IN INJURY OR DEATH TO YOURSELF OR OTHERS.**

**BE CAREFUL!**

## 2. TECHNICAL INFORMATION

### 2.1. NOMENCLATURE

RIGHT VIEW OF THE FN FIVE-SEVEN® MRD

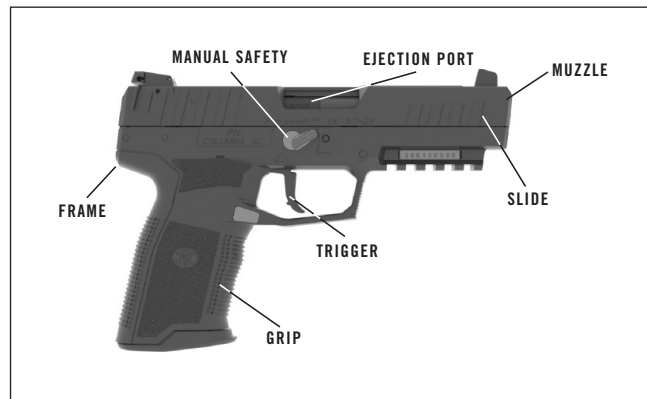

LEFT VIEW OF THE FN FIVE-SEVEN® MRD

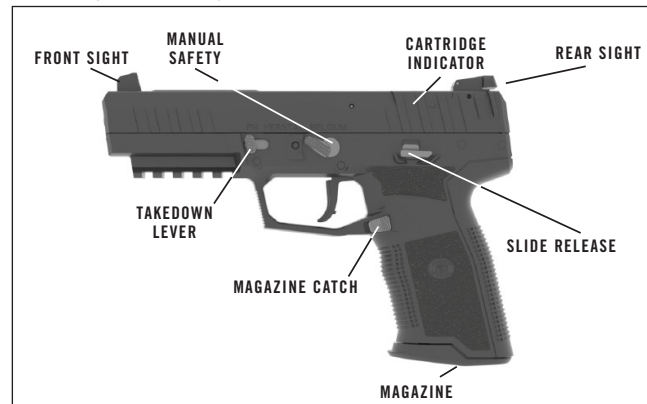

In conventional gun terminology, the position and movement of pistol parts are described as they occur with the pistol horizontal and in normal firing position: the muzzle is forward or front, the pistol grip is rearward or rear, the trigger is downward or underneath, the sights are upward or on top.

## 2.2. FUNCTIONING

The FN Five-seveN®MRD pistol is a modern 5.7x28mm single-action, delayed blowback, and semi-automatic pistol.

With the chamber and the magazine loaded (as described in § 4.3 and § 4.4) and the manual safety at the “fire” position, the pistol will fire a single shot with each successive pull of the trigger until the magazine and the chamber are empty.

The slide of this pistol is designed to stay open after the last round has been fired.

## 2.2.1 CARTRIDGE INDICATOR

**⚠ WARNING**

**READ AND HEED ALL WARNINGS IN THIS OWNER’S MANUAL, ON THE AMMUNITION BOXES AND WITH ALL THE ACCESSORIES THAT YOU INSTALL ON YOUR FIREARM.**

**IT IS YOUR RESPONSIBILITY TO SECURE THE MOST UP-TO-DATE INFORMATION ON THE SAFE HANDLING PROCEDURES FOR YOUR FN FIREARM.**

**FN HERSTAL AND FN AMERICA, LLC ASSUME NO LIABILITY FOR INCIDENTS WHICH OCCUR WHEN UNSAFE OR IMPROPER PISTOL ACCESSORIES OR AMMUNITION COMBINATIONS ARE USED.**

If the cartridge indicator, located at the left side on top of the pistol, is protruding, it means that there is a round in the chamber.

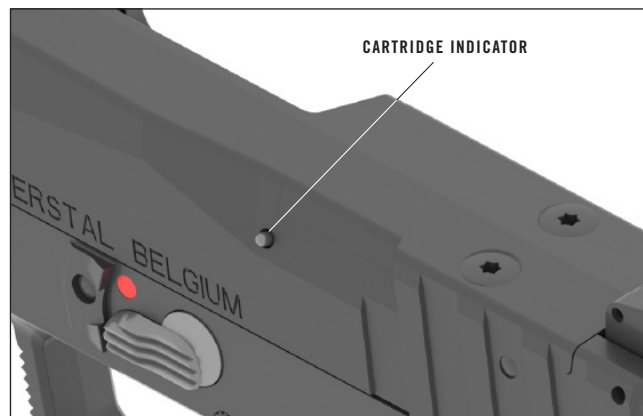

## 2.2.2. MANUAL SAFETY

The FN Five-seveN® MRD pistol has an ambidextrous manual safety: a manual safety lever is available on the right and left side of the frame for the convenience of both right- and left-handed shooters.

The manual safety can be set at one of the following 2 positions:

- The “safe” position (NO red marks visible)

When the manual safety is at its raised position, the trigger is blocked from moving.

-At the end of the safety checks.

-When the FN Five-seveN® MRD pistol is not operational (carrying, cleaning, stored, ...)

-When preparing the FN Five-seveN® MRD pistol for firing.

The “safe” position should be selected in one of the following cases:

- The “fire” position (red marks visible)

When the manual safety is at its lowered position, the trigger can be moved and, on the condition that a round is loaded in the chamber as described in § 4.4, a single round will be fired when the trigger is pulled.

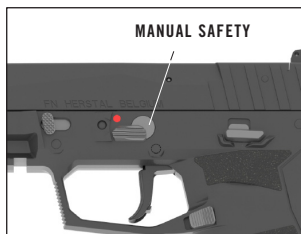
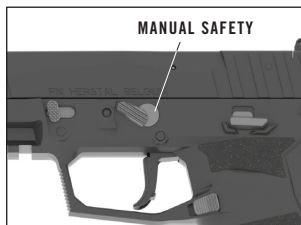

## 2.2.3. OPERATION OF THE HAMMER

### **▲ WARNING**

Never try to decock the cocked hammer of a loaded FN Five-seveN®.

ALWAYS consider the pistol as ready-to-fire when the cartridge indicator is protruding and the manual safety is at the “fire” position!

The single-action FN Five-seveN® MRD pistol has an internal (not visible) hammer with decocked and cocked positions.

**DECOCKED HAMMER**

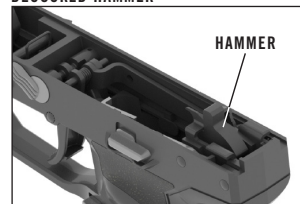

**COCKED HAMMER**

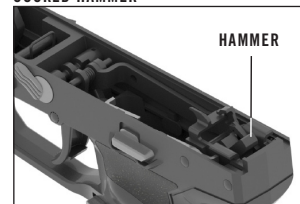

*Views after removing the slide assembly from the pistol.*

- Decocked position

The recommended position when shooting is not imminent or for storage.

*At this position, the hammer is fully fallen and resting against the inertia firing pin which is not in contact with the primer of the round.*

- Cocked position

The hammer is all the way to the rear.

*In the cocked position, with the manual safety at the “fire” position and with a round in the chamber, the pistol is ready to fire by pulling the trigger.*

## 2.3. MAGAZINES AND AMMUNITION

### 2.3.1. MAGAZINES

The magazines supplied with the pistol have a total magazine capacity of 20 rounds each (10 rounds where restricted by law).

20-ROUND MAGAZINE



10-ROUND MAGAZINE



*With an additional round in the chamber, the pistol has a total capacity of 11 or 21 rounds. However, as we recommend that, unless*

*shooting is imminent, no round should be loaded in the chamber of the pistol, the recommended maximum carrying capacity is 10 or 20 rounds in the magazine with the chamber empty.*

*This magazine is unique for the FN Five-seveN® MRD pistol and should not be used in other pistols and no other magazines should be used in your FN Five-seveN® MRD pistol.*

The left side of the magazine is provided with four openings which allow you to estimate the number of rounds left.

*If a round is visible in the hole “20” (or “10”), the magazine is fully loaded while the other holes simply offer you the possibility to estimate the number of rounds still in the magazine.*

The magazine is ejected from the FN Five-seveN® MRD by pressing the magazine catch.

*It is recommended to use the thumb of the shooting hand to press the magazine catch and to use the support hand to catch the ejected magazine.*

MAGAZINE CATCH



The magazine catch is reversible and can be switched to the other side (for more information, refer to § 6.3).

#### NOTE

The FN Five-seveN® MRD pistol contains a magazine disconnect.

This disconnect is designed to prevent the FN Five-seveN® MRD pistol from being fired if the magazine has been removed.

### 2.3.2. AMMUNITION

#### ▲WARNING

**EXAMINE EACH ROUND BEFORE YOU PUT IT IN YOUR PISTOL!**

**THE BARREL AND THE SLIDE OF YOUR FIREARM HAVE BEEN MADE WITH SUBSTANTIAL SAFETY MARGINS WITH REGARD TO THE PRESSURES DEVELOPED BY THE 5.7X28MM AMMUNITION DESIGNED BY FN HERSTAL.**

**HOWEVER, FN HERSTAL AND FN AMERICA, LLC ASSUME NO LIABILITY FOR ACCIDENTS WHICH OCCUR THROUGH THE USE OF RELOADED AMMUNITION OR 5.7X28MM ROUNDS NOT FABRICATED ACCORDING TO THE FN HERSTAL STANDARDS.**

The FN Five-seveN® MRD pistol must only be used with the following new factory manufactured 5.7x28mm supersonic ammunition:

- SS195LF
- SS197SR

## 3. CONTENTS OF THE STORAGE BOX

#### ▲WARNING

**USE THE SAFETY LOCK TO SAFELY STORE AND TRANSPORT THE PISTOL.**

The pistol and its accessories are supplied in a pistol case.

Contents of the case:

- A pistol with 20-round magazine
- (10-round magazine when required by law)
- A safety lock
- Optics Mounting System: 3 interfaces and 3 sets of 2 securing screws
- T10 Torx wrench
- An Owner's Manual

## 4. USING THE PISTOL

### ▲WARNING

**BEFORE USING YOUR FN FIVE-SEVEN® MRD PISTOL, BE FAMILIAR WITH THE SAFETY INFORMATION GIVEN IN CHAPTER 1 OF THIS OWNER'S MANUAL**

### 4.1 SAFETY CHECKS

### ▲WARNING

**BEFORE USING YOUR FN FIVE-SEVEN® MRD PISTOL, BE FAMILIAR WITH THE SAFETY INFORMATION GIVEN IN CHAPTER 1 OF THIS OWNER'S MANUAL.**

**BEFORE PROCEEDING, READ AND UNDERSTAND § 2.2 WHICH BRIEFLY DESCRIBES THE FUNCTIONING OF YOUR PISTOL, AND ESPECIALLY OF ITS (INTERNAL) HAMMER.**

**KEEP YOUR FINGER AWAY FROM THE TRIGGER WHILE LOADING, UNLOADING OR REMOVING THE MAGAZINE.**

**ONLY TOUCH THE TRIGGER WHEN YOU ARE READY TO SHOOT OR WHEN DECOCKING THE HAMMER.**

**NEVER TRY TO DECOCK THE COCKED HAMMER OF A LOADED FN FIVE-SEVEN® MRD PISTOL!**

Carry out the following procedures to ensure that the pistol can be operated, stored and/or transported without any risk:

- Point the pistol in a safe direction.
- Set the manual safety at the “safe” position.

*When the manual safety is at the “safe” position, the red marks are NOT visible.*



- Press the magazine catch to eject the magazine.

*If the magazine does not eject, pull on the bottom plate of the magazine.*

- Pull the slide completely rearward and then release it to eject any remaining round from the chamber.

*If the slide is already automatically locked into the rearward position after having fired the last round (also refer to § 4.6), this step is not necessary: grab the slide with your support hand and then press the slide release downwards or pull the slide rearward to let the slide return to its forward position.*



*If a round was ejected, do not forget to recover, clean and store the round.*

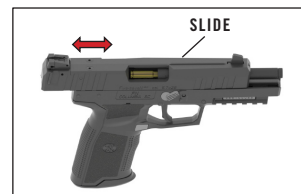

- Pull the slide completely rearward and hold it in that position.
- Through the ejection port, look into the chamber of the pistol to ensure that there is no round in the chamber.

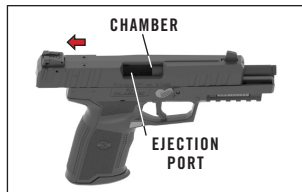

*If there is a round in the chamber, release the slide and then try to extract and eject the remaining round by pulling the slide completely rearward and then releasing it.*

*If the round is not ejected, consult the FN Service Center or your departmental armorer.*

- If the chamber is empty, release the slide.
- **Double-check the chamber of the pistol to ensure that it is empty.**
- If the magazine is not empty, unload the magazine by removing the rounds one by one.

*Slightly push down on the top round and then carefully push it forward and release it from the lips of the magazine.*

*Repeat this procedure until the magazine is completely empty.*

*If necessary, unload the spare magazines as well.*

- Insert an **empty** magazine.
- Please note that a special magazine disconnect prevents pulling the trigger if the pistol does not contain a magazine.*
- Set the manual safety to the “fire” position.
- After having ensured that the pistol is unloaded, point it in a safe direction and then pull the trigger to decock the hammer.
- Set the manual safety at the “safe” position.

## INITIAL CLEANING

It is mandatory to clean your FN Five-seven® MRD before using it for the first time, and after every subsequent use.

Carry out the cleaning procedure of § 6.4.1 “Cleaning and lubrication before firing” to remove any preservation lubricant.

For law enforcement and military personnel, refer to the procedures of your department.

If the pistol contains hardened grease or other substances that you cannot remove, please contact the FN Service Center or your departmental armorer.

## 4.2. REAR SIGHT ADJUSTMENT

If necessary, the rear sight can be adjusted with an appropriate screwdriver.

### HORIZONTAL SETTING

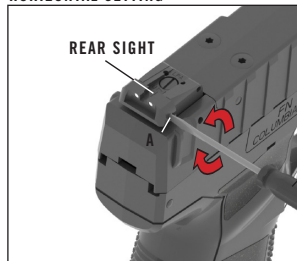

### VERTICAL SETTING

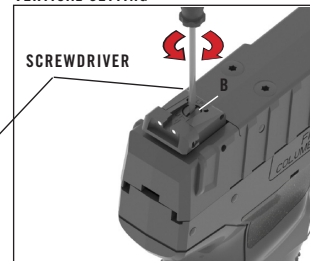

## HORIZONTAL SETTING OF THE REAR SIGHT

*Use the screwdriver to turn the windage adjustment screw “A.”*

*To move the point of impact to the right or to the left, turn the windage adjustment screw “A” in the clockwise or counterclockwise direction respectively.*



## VERTICAL SETTING OF THE REAR SIGHT

*Use the screwdriver to turn the vertical adjustment screw “B.”*

*To lower or raise the point of impact, turn the vertical adjustment screw “B” in the clockwise or counterclockwise direction respectively.*

## 4.3. LOADING THE MAGAZINE

### **▲WARNING**

Only load the number of rounds you intend to shoot.

Do not insert the loaded magazine into the pistol nor load a round into the chamber unless shooting is imminent.

Never keep a loaded magazine next to the pistol.

For law enforcement and military personnel, refer to the procedures of your department on carrying a loaded pistol with a round in the chamber.

*As explained in § 2.3.1, the magazines supplied with the pistol have a capacity of 10 or 20 rounds.*

- If the magazine to be loaded is still in the pistol, first set the manual safety at the “safe” position and then press the magazine catch to eject the magazine.

- Load the rounds, one by one, into the magazine.

*Place the round on top of the lips of the magazine and with the rear of the cartridge aligned with the rear of the magazine.*

*With a thumb, push down on the round (against the force of the spring) until it locks into position under the lips of the magazine.*

*The side openings in the magazine body allow you to estimate the number of rounds present in the magazine.*

20-ROUND MAGAZINE



10-ROUND MAGAZINE



#### 4.4. LOADING THE PISTOL

- Carry out the safety checks as described in § 4.1.
- If not already done, keep the pistol pointed in a safe direction and press the magazine catch to eject the empty magazine (also refer to § 2.3.1).
- Insert a loaded magazine and firmly push on the bottom of the magazine to lock it.
- Being extremely careful not to touch the trigger, hold the pistol in your shooting hand, point in a safe direction, pull the slide completely rearward with your support hand and then release the slide which returns by the tension of the return spring.

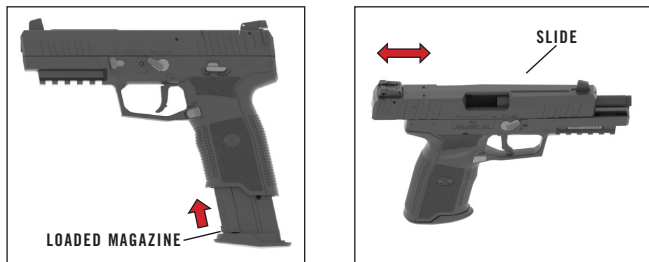

*This causes the first round to be loaded into the chamber and the hammer to be cocked (the cartridge indicator protrudes to indicate the presence of a round in the chamber).*

*To ensure a correct chambering of the round, let the slide “slam” forward under the force of the spring, do not ease it forward.*

#### **▲WARNING**

Be careful!

If the manual safety is now set at the “fire” position, the pistol can be fired by pulling the trigger!

If shooting is not imminent, carry out the safety checks as described in § 4.1 for proper storage.

#### 4.5. FIRING

#### **▲WARNING**

Before firing, read the entire Owner’s Manual: warnings and instructions are different for each pistol.

Before each shooting sequence, ALWAYS check the barrel for obstructions and ensure that it is dry and clean.

*It is assumed that the rear sight has been adjusted correctly (also refer to § 4.2).*

Ensure that § 6.4.1 “Cleaning and lubrication before firing” has been carried out.

- If not already done, load the pistol as described in § 4.4.
- Point the pistol in a safe direction and set the manual safety at the “fire” position.

**▲WARNING**

When firing, the slide will move approximately 2" past the rear end of the frame: never hold your hand in a position where it could be hit by the slide and never hold the pistol close to the eyes when aiming!

- Point the pistol at the target and pull the trigger to fire the first round.

*The FN Five-seveN® MRD pistol is a single-action pistol resulting in a rather light and short trigger pull.*

*After firing a shot, release the trigger so that it resets to the forward position.*

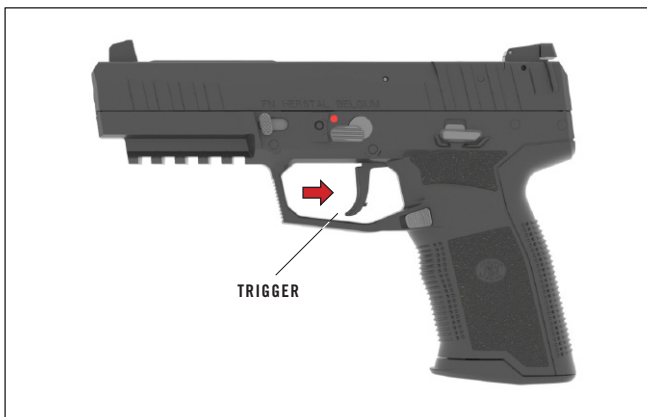

- Keep the pistol pointed at the target and fire additional rounds as required.

After each fired round, the pistol will cock the hammer, eject the used cartridge case and feed a round from the magazine into the chamber.

If the pistol is fired until the magazine is empty, the slide will remain open when the last round has been fired (refer to § 4.6).

**▲WARNING**

If firing is interrupted, even briefly, place the manual safety in the "safe" position.

After firing is completed, carry out the safety checks as described in § 4.1.

#### 4.6. RELOADING DURING FIRING

**▲WARNING**

During this operation, be careful not to touch the trigger.

Only touch the trigger when you are ready to fire.

After firing the last round, the slide will remain locked into the rear position.

At this point, the empty magazine can quickly be replaced with a loaded magazine, by proceeding as follows:

- Keep the pistol pointed in a safe direction and press the magazine catch to eject the empty magazine (also refer to § 2.3.1).

- Insert a loaded magazine and firmly push on the bottom of the magazine to lock it.
- Grab the slide, pull slightly to the rear with your support hand and then press the slide release downward to disengage it or pull the slide rearward and let go: the slide will return to the forward position and the first round will be loaded into the chamber.

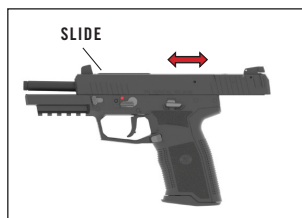
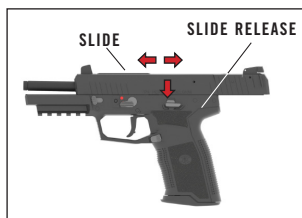

*Allow the slide to return forward under full force of the return spring. Failure to do so may result in a feeding failure.*

*Please note that the hammer is still in the cocked position: the pistol will be ready to fire.*

*The cartridge indicator protrudes to indicate the presence of a round in the chamber.*

- Resume firing.

### **▲WARNING**

If firing is interrupted, even briefly, place the manual safety in the “safe” position.

After firing is completed, carry out the safety checks as described in § 4.1.

## 4.7. UNLOADING THE PISTOL

- To unload the pistol, carry out the safety checks as described in § 4.1.

## 4.8. DECOCKING THE HAMMER

### **▲WARNING**

Never try to decock the cocked hammer of a loaded FN Five-seveN® MRD pistol!

To decock the hammer, carry out the safety checks as described in § 4.1.

If you do not intend to shoot immediately after having cocked the pistol, you should carry out the safety checks to decock the cocked hammer.

For law enforcement personnel, refer to the procedures of your department on decocking a cocked hammer.

## 5. OPTICS MOUNTING SYSTEM

The Optics Mounting System allows for the installation of many available pistol-compatible optical sights. The Optics Mounting System consists of an interface and securing screws.

## 5.1. INSTALLING AN OPTIC

Carry out the safety checks as described in § 4.1.

Loosen and remove the two securing screws holding the cover plate to the slide by turning the screws counterclockwise using the provided T10 Torx wrench.

Remove the cover plate.

Inspect and clean the mounting surface on the top of the slide.

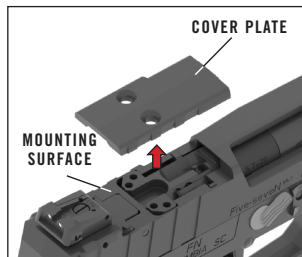
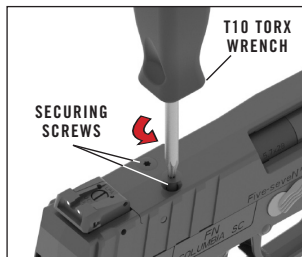

- Select the appropriate securing screws and, if applicable, the interface to match the optic you are installing.

*Refer to the “Mounting system chart” in § 5.3 for more information.*

- Remove all lubrication from the selected securing screws and their screw holes in the slide and, if applicable, the interface.
- Position the optic on top of the slide.

*If it is required to install an interface under the optic, the interface should be installed at this time.*

- Add a medium-strength threadlocker, such as Loctite Blue 242® to both securing screws and tighten clockwise with the provided T10 Torx wrench. Follow the cure time instructions provided with the threadlocker.

*The recommended torque is 22 in.-lbs.*

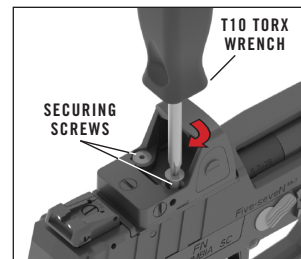
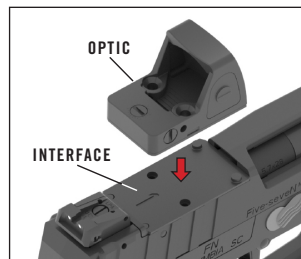

## 5.2. REMOVING AN OPTIC

- Carry out the safety checks as described in § 4.1.
- Loosen and remove the two securing screws holding the optic and, if applicable, the interface to the slide by turning the screws counterclockwise using the provided T10 Torx wrench.
- Remove the optic and, if applicable, the interface from the slide.

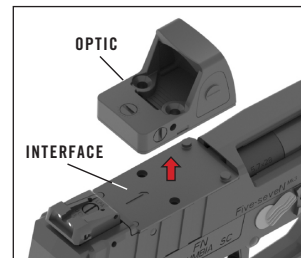
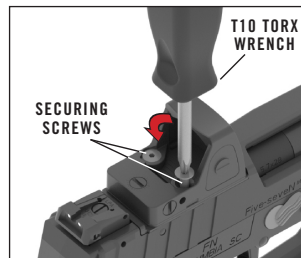

- Position the cover plate on the slide and secure it by tightening the two securing screws clockwise with the provided T10 Torx wrench.

The recommended torque is 22 in-lbs.

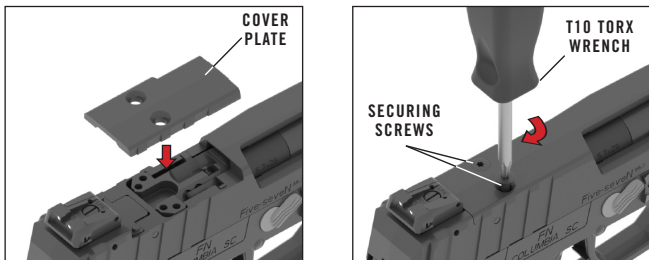

To install another optic instead, perform the installation of the new optic as described in § 5.1.

### 5.3. MOUNTING SYSTEM CHART

Cover plate/optic	Interface	Securing screws
Cover plate	Not required	500
Burris FF2 & FF3	Not required	500
Vortex Viper	503	500
Vortex Venom	Not required	502
Trijicon RMR	501	501
Leupold DeltaPoint Pro	502	503

### HOW TO IDENTIFY INTERFACES

Each interface has an identification engraving. Interface 501 has the engraving “1,” interface 502 has the engraving “2” and interface 503 has the engraving “3.”

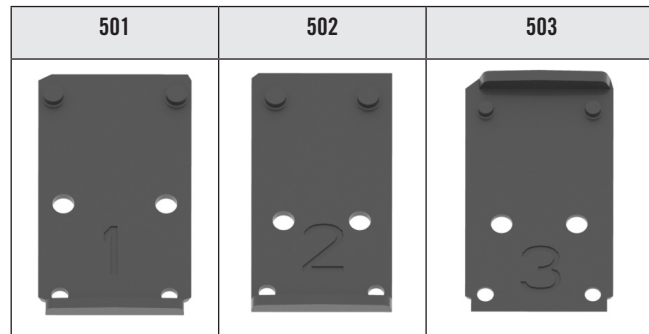

### HOW TO IDENTIFY SECURING SCREW TYPES

All the securing screws are Torx screws, but they vary in length.

Securing screw types 500 and 502, which are close together in length, can be easily distinguished because of their different screw head shapes.

500	501	502	503
Length: 0.41”	Length: 0.53”	Length: 0.45”	Length: 0.74”

## 6. MAINTENANCE

### 6.1. DISASSEMBLING AND REASSEMBLING THE PISTOL

*It is very important to become familiar with the disassembly procedure of the pistol as disassembly is required during the cleaning and lubrication procedure which ensures reliable operation of the pistol.*

#### 6.1.1. DISASSEMBLING THE PISTOL

- Carry out the safety checks as described in § 4.1.

*During the safety checks, DO NOT insert an empty magazine into the pistol and DO NOT decock the hammer.*

- Hold the pistol in the right hand.
- With the palm of the left hand, push the slide approximately 0.25" rearward and hold it in that position.
- At the same time, and using the left thumb, push the takedown lever completely rearward and hold it in that position.
- Release the slide so that it moves back forwards.

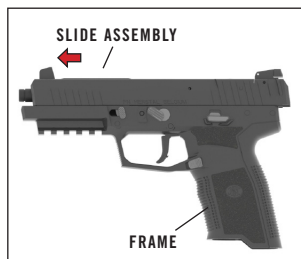

- With the right thumb, push forward on the rear end of the slide to disengage the complete slide assembly from the frame.
- Lift the slide assembly up and off the frame.

- With the slide assembly held upside down, disengage the rear end of the barrel.



- Take the barrel out of the slide.

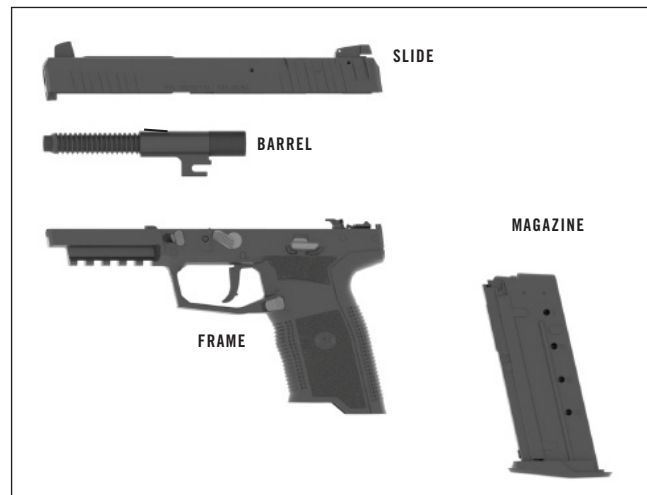

#### CAUTION

This level of disassembly is sufficient to perform thorough cleaning.

Further disassembly should only be carried out by a qualified armorer or by the FN Service Center.

## 6.1.2. REASSEMBLING THE PISTOL

- Ensure that all the components of the pistol are perfectly clean (refer to § 6.4.2).
- Insert the muzzle of the barrel into the barrel opening at the front side of the slide.
- Push the barrel slightly forward against the force of the return spring and then fit the rear end of the barrel into position in the slide.



### NOTE

Before carrying out the next step, ensure that the stripping lever is at the rear position, that the frame does not contain a magazine and that the hammer is in the cocked position.

- While holding the slide assembly parallel above the frame, align the rear end of the slide assembly with the front end of the rear guide slides of the frame.
- Lower the slide assembly onto the frame and then move it slightly rearward just enough to fit the front and rear guide slides of the frame into the grooves of the slide assembly.
- Ensure that the slide assembly has correctly engaged the frame.
- Move the slide assembly completely rearward.
- Check if the slide can smoothly be moved back and forth.

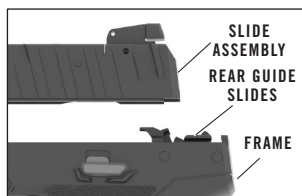

## 6.2. DISASSEMBLING AND REASSEMBLING THE MAGAZINE

*Disassembling the magazine for cleaning and lubrication is only necessary in case of apparent soiling of the magazine.*

### 6.2.1 DISASSEMBLING AND REASSEMBLING THE 20-ROUND MAGAZINE

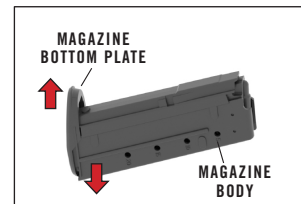
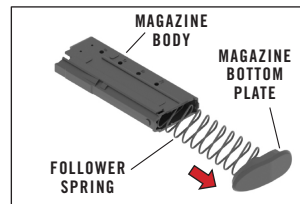

### DISASSEMBLY

- If not already done, press the magazine catch to eject the magazine from the pistol and completely unload the magazine (refer to § 4.1).
- While holding the rear end of the magazine bottom plate against a solid but soft surface, press down on the magazine to disengage the bottom plate.

*Using a hard surface may damage the magazine bottom plate.*

- Taking into account that the magazine bottom plate is subject to the force of the follower spring, slide the magazine bottom plate from the magazine body and then carefully release the pressure on the follower spring.
- Take the follower and the follower spring out of the magazine body.

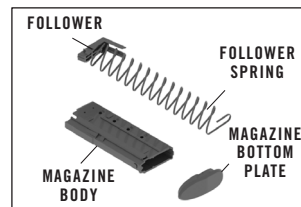



## CAUTION

This level of disassembly is sufficient to perform thorough cleaning.

Further disassembly should only be carried out by a qualified armorer or by the FN Service Center.

## REASSEMBLY

To reassemble the magazine, follow the disassembly steps in reverse order, taking into account the following points:

- Ensure that the components of the magazine are perfectly clean.
- Ensure that the follower and the follower spring are correctly oriented.
- The magazine bottom plate can only be slid back into position when the follower spring is compressed and held flush with the edge of the magazine body.
- Ensure that the magazine bottom plate correctly locks into position.

### 6.3. REVERSING THE MAGAZINE CATCH

#### **⚠ WARNING**

Ensure that your FN Five-seven® MRD pistol is unloaded (refer to § 4.1).

If desired, the magazine catch can be moved to the other side of the FN Five-seven® MRD pistol.

*The following procedure describes the reversal of the magazine catch from the left side to the right side.*

*For a reversal from the right side to the left side, use the same procedure.*

To reverse the magazine catch, proceed as follows:

- Remove the slide assembly as described in § 6.1.1.
- Set the manual safety at the “fire” position in order to pull the trigger when asked during the following procedure.
- While pulling the trigger and using a 3/32” drift punch, pull the magazine catch spring out of its housing inside the frame and then remove it.
- Take the magazine catch out of the right side of the pistol.

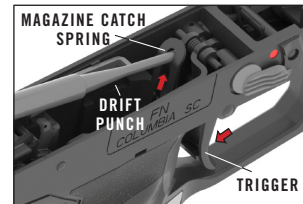

- From the left side, insert the magazine catch, oriented correctly and with its ridged side first, into its housing in the frame.

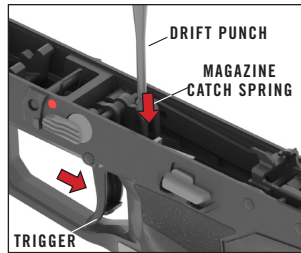
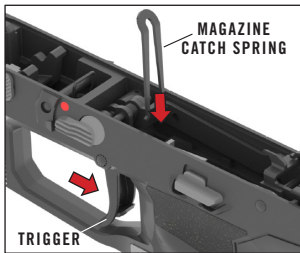

- While pulling the trigger, reinstall the magazine catch spring, oriented as shown, into its housing inside the frame.

*Ensure that the extremities of the magazine catch spring fit correctly into the frame and into the notches of the magazine catch.*

- Using the 3/32" drift punch, push the magazine catch spring completely home.

*Ensure that the magazine catch spring fits correctly into position: 2 "clicks" should be heard.*

- Reinstall the slide assembly as described in § 6.1.2.

## 6.4. CLEANING AND LUBRICATION

### **▲WARNING**

Before cleaning the pistol, ALWAYS carry out the safety checks as described in § 4.1.

Keep ammunition away from the cleaning site and never test the mechanical function of your pistol with live ammunition.

The frequency at which the pistol should be cleaned and lubricated depends on the ammunition used, the weather and shooting conditions and other external factors.

A good rule is to clean and lubricate the pistol after every use or, in case of intensive shooting, after 500 rounds: correct maintenance will enhance the longevity and the performance of your pistol.

Excessively dirty ammunition may require more frequent cleaning and too much dirt can affect the functioning of even the finest firearm.

It is important to keep your pistol clean and correctly lubricated!

Do not use too much lubricant as this could cause the build-up of dirt, grit or powder residue which could affect the functioning of the pistol.

For more information about the recommended lubricants, refer to "Lubricants" in chapter 7.

### **CAUTION**

We do not recommend prolonged exposure to hydrocarbons, trichlorethylene nor ammonia. These chemicals could cause damage to your pistol!

## 6.4.1. CLEANING AND LUBRICATION BEFORE FIRING

*The following procedure assumes that the pistol has correctly been cleaned and lubricated the last time it was used (also refer to § 6.4.2).*

- Disassemble the pistol as described in § 6.1.1.
- Using a cleaning rod and cleaning patches, work back and forth to remove any lubricant from the bore and the chamber of the barrel until the last cleaning patch is clean.
- Ensure that the inside of the barrel is perfectly dry.
- Reassemble the pistol as described in § 6.1.2.

**▲ WARNING**

Before each shooting sequence, ALWAYS check the barrel for obstructions and ensure that it is dry and clean.

Carry out the safety checks as described in § 4.1. After having ensured that the firearm is completely unloaded, pull the slide completely rearwards and look through the barrel to ensure that it is clear of any obstruction. If an obstruction is seen, no matter how small it may be, clean the bore of the barrel.

Take into account that the smallest obstruction can dangerously increase pressures.

## 6.4.2. CLEANING AND LUBRICATION AFTER FIRING

- Disassemble the pistol as described in § 6.1.1.
- Using cleaning brushes or a spray, apply solvent inside the barrel (bore and chamber) and let the product work for a few minutes.
- Using a cleaning rod and cleaning patches, work back and forth to remove the solvent and the residues from the bore and the chamber of the barrel until the last cleaning patch is clean.
- When the bore and the chamber of the barrel are clean, again use a cleaning patch, this time moistened with lubricant, to protect the inside of the barrel until the next use.

*Please note that the inside of the barrel should be wiped dry before shooting (also refer to § 6.4.1).*

- Using cleaning brushes and solvent, remove any carbon and other deposits from the areas of the pistol attracting powder and primer residues: the slide, the extractor, the upper part of the frame, ...
- Using a soft cloth or a cleaning patch (if necessary, dipped in solvent),

remove any dirt from the magazine housing of the frame.

- Check the disassembled parts of the pistol for signs of wear and/or damage.

*In case of doubt about the condition of a part, consult the FN Service Center or your departmental armorer.*

- Thoroughly clean all the parts of the pistol to remove any dirt, debris or fouling.
- Apply one drop of lubricant to the outer surface of the barrel, the return spring, the inside of the slide (especially the grooves for the guide slides and the part of the bottom of the slide which comes into contact with the hammer), the guide slides of the frame as well as the hammer (its contact area with the slide).

*Never apply lubricant to the breech face.*

- Reassemble the pistol as described in § 6.1.2.
- Clean the outside of the pistol to remove dirt, finger print residue and excessive lubricant.

## 6.4.3. CLEANING AND LUBRICATION OF THE MAGAZINE

*Cleaning and lubrication of the magazine is only necessary in case of apparent soiling of the magazine.*

- Disassemble the magazine as described in § 6.2.
- Thoroughly clean all the parts of the magazine (if necessary, use solvent).
- Using a cleaning patch moistened with lubricant, lightly apply lubricant to the follower spring.

*Wipe off excess lubricant. Ensure that the inside of the magazine is dry.*

- Reassemble the magazine as described in § 6.2.

## 6.5. ADDITIONAL CARE

### **▲ WARNING**

Never modify or repair parts of your pistol by yourself.

FN HERSTAL and FN AMERICA, LLC cannot assume any responsibility for injuries caused by unauthorized servicing, alterations or modifications to its firearms.

Your pistol is a mechanical device subject to wear and will not last forever: it requires periodic inspection, adjustment and service.

The pistol should be checked every 2000 rounds and/or once a year because damage, wear, or corrosion are not always visible from the outside.

Law enforcement personnel have a departmental armorer which will inspect the pistol on a yearly basis.

- 1. ALWAYS KEEP THE PISTOL IN IMMACULATE CONDITION AND GOOD WORKING ORDER.**
- 2. ALWAYS CLEAN AND LUBRICATE THE PISTOL AFTER USE.**
- 3. REGULARLY INSPECT THE PISTOL, ITS PARTS AND THE ACCESSORIES.**

If something seems abnormal, please contact the FN Service Center or your departmental armorer.

## 7. ADDITIONAL INFORMATION

### SIGHT ADJUSTMENT

For a more accurate setting of the sights than the procedures described in § 4.2, consult the FN Service Center or departmental armorer.

### LUBRICANTS

FN HERSTAL and FN AMERICA, LLC recommend using lubricant Nycolube 127 CLP or equivalent (reference US MIL - PRF63460 or NATO S-758).

*For the U.S. Market, CLP is available under the following names and trademarks:*

- *CLP-NC by BREAK-FREE INC*
- *SENT-CLP by SENTINEL CANADA*
- *ROYCO-634 by ROYAL LUBRICANTS Co, INC*

*Be aware that some solvents can be harmful to the surface finish of the pistol, so consult your the FN Service Center or your departmental armorer if the solvent you wish to use is not listed above.*

## 8. WARRANTY, SERVICE AND TECHNICAL QUESTIONS

### RETURNING YOUR FIREARM FOR SERVICE

When returning your FN firearm for servicing, you must abide the following guidelines:

#### NOTE

For all Federal Firearms License (FFL) holders: to avoid unnecessary return shipping delays, please submit an FFL when a firearm is sent in for service.

1. Complete the online sign-up form to create an account with our Service Center and to request service via [www.fnamerica.com](http://www.fnamerica.com).
2. Ensure that the pistol is completely unloaded (refer to § 4.1).
3. Remove all accessories.
4. Package it securely in a double-packed cardboard container.
5. Include a copy of your service request confirmation with your firearm that clearly describes the nature of your repair concerns or service desired. If the service form is NOT included with your firearm your service will be delayed.
6. Include a daytime phone number where you can be reached.
7. Never return ammunition with your firearm. It is against postal and most commerce regulations.
8. Do not remove any compliant parts or features required by law.

#### NOTE

FN HERSTAL or FN AMERICA, LLC is not responsible for damage incurred during shipping.

FN HERSTAL or FN AMERICA, LLC is not responsible for lost or damaged aftermarket accessories.

## DISCLAIMER

Any addition to your FN firearm of aftermarket accessories (such as suppressors, triggers, muzzle devices, stocks, etc.) is considered a modification of your firearm from its original configuration, which may void your warranty. We are unable to adapt each firearm for every variable effect that might occur when you install a third-party manufacturer's accessory on an FN firearm.

Therefore, FN disclaims all responsibility and liability for any damage caused to you and/or your firearm as a result of aftermarket accessory use. If an aftermarket accessory causes damage to you and/or your firearm, please address your concerns with the accessory manufacturer.

This Owner's Manual should always accompany this pistol and be transferred with it upon any change of ownership.

#### NOTE

If you do not understand the instructions for operating your FN firearm, it is your responsibility to contact the FN Service Center at **(800)-635-1321** before using the firearm.

If you have any further questions, please call the FN Service Center at **(800)-635-1321** Technical specifications.

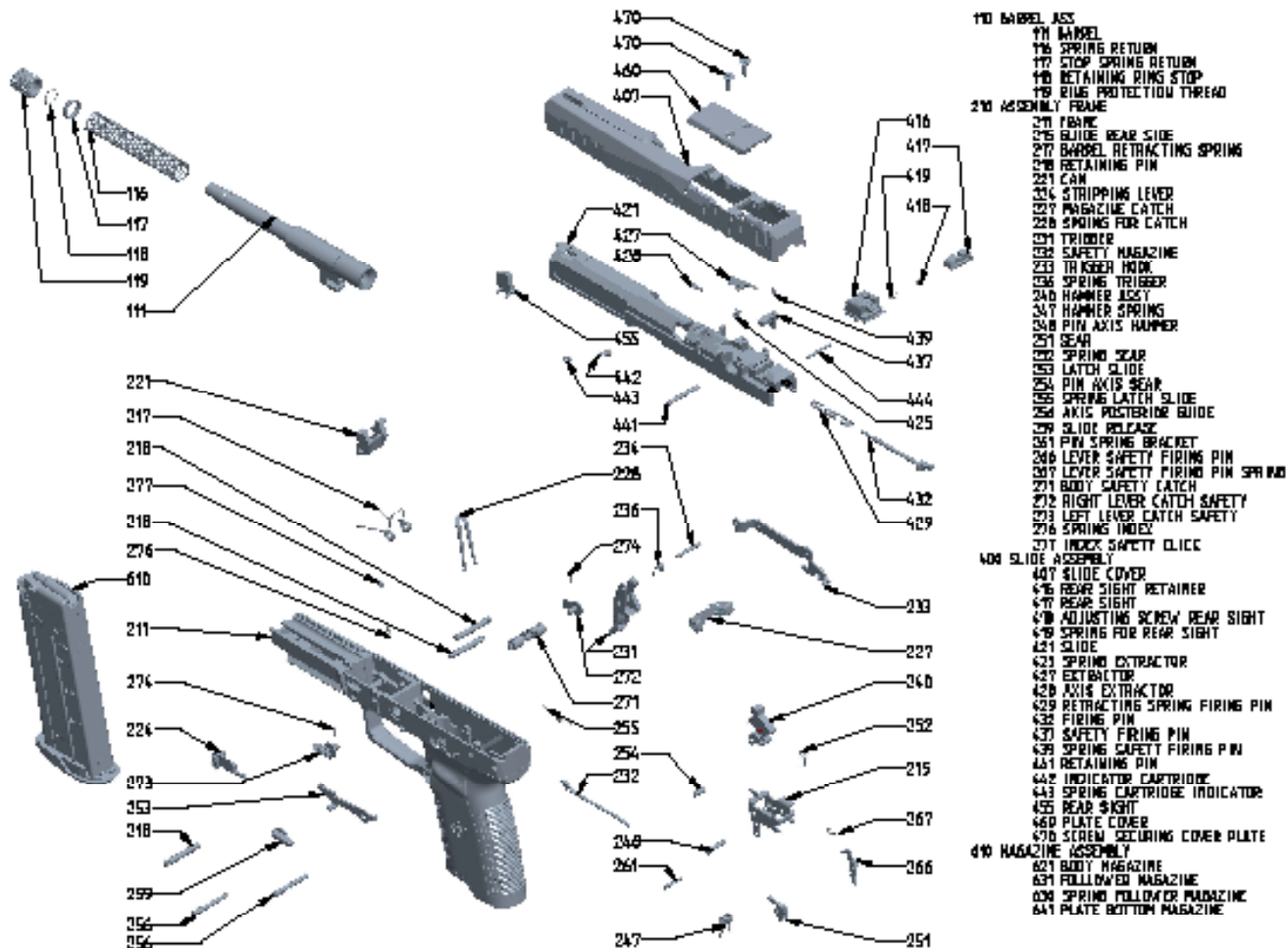

- 100 BARREL ASS
- 111 BARREL
- 116 SPRING RETURN
- 117 STOP SPRING RETURN
- 118 RETAINING RING STOP
- 119 RING PROTECTION THREAD
- 200 ASSEMBLY FRAME
- 211 FRAME
- 215 SLIDE REAR SIDE
- 217 BARREL RETRACTING SPRING
- 218 RETAINING PIN
- 221 CAN
- 224 STRIPPING LEVER
- 227 MAGAZINE CATCH
- 228 SPRING FOR CATCH
- 231 TRIGGER
- 232 SAFETY MAGAZINE
- 233 TRIGGER HOOK
- 236 SPRING TRIGGER
- 240 HAMMER BOLT
- 241 HAMMER SPRING
- 242 PIN AXIS HAMMER
- 251 BEAR
- 252 SPRING SCAR
- 253 LATCH SLIDE
- 254 PIN AXIS BEAR
- 255 SPRING LATCH SLIDE
- 256 AXIS POSTERIOR GUIDE
- 259 SLIDE RELEASE
- 261 PIN SPRING BRACKET
- 266 LEVER SAFETY FIRING PIN
- 267 LEVER SAFETY FIRING PIN SPRING
- 271 BODY SAFETY CATCH
- 272 RIGHT LEVER CATCH SAFETY
- 273 LEFT LEVER CATCH SAFETY
- 274 SPRING INDEX
- 277 INDEX SAFETY CLICK
- 400 SLIDE ASSEMBLY
- 407 SLIDE COVER
- 416 REAR SIGHT RETAINER
- 417 REAR SIGHT
- 418 ADJUSTING SCREW REAR SIGHT
- 419 SPRING FOR REAR SIGHT
- 421 SLIDE
- 423 SPRING EXTRACTOR
- 427 EXTRACTOR
- 428 AXIS EXTRACTOR
- 429 RETRACTING SPRING FIRING PIN
- 432 FIRING PIN
- 437 SAFETY FIRING PIN
- 439 SPRING SAFETY FIRING PIN
- 441 RETAINING PIN
- 442 INDICATOR CARTRIDGE
- 443 SPRING CARTRIDGE INDICATOR
- 455 REAR SIGHT
- 460 PLATE COVER
- 470 SCREW SECURING COVER PLATE
- 400 MAGAZINE ASSEMBLY
- 421 BODY MAGAZINE
- 431 FOLLOWER MAGAZINE
- 436 SPRING FOLLOWER MAGAZINE
- 441 PLATE BOTTOM MAGAZINE

## 9. TECHNICAL SPECIFICATIONS

### NOTE:

	<b>FN Five-seveN® MRD</b>
Caliber:	5.7x28mm
Type of fire:	Semi-automatic
Trigger pull:	Single-action: 4.4 to 7.8 lb
Weight w/o Magazine (oz):	25.12 lbs.
Length (in.):	8.20
Height (in.):	5.60
Width (in.):	1.35
Barrel length (in.):	4.80
Number of grooves:	8
Twist Rate (in.):	1:9.1", RH
Magazine capacity:	20 rounds (10 rounds where restricted by law)

*All specifications are subject to change without notice.*

**NOTE:**

**NOTE:**





**FN**  
**FIVE-SEVEN MRD**

**FNAMERICA.COM**

**FN AMERICA, LLC**  
**P.O. 9424**  
**McLean, VA 22102**  
**fnamerica.com**