

SIG SAUER[®]
when it counts[®]

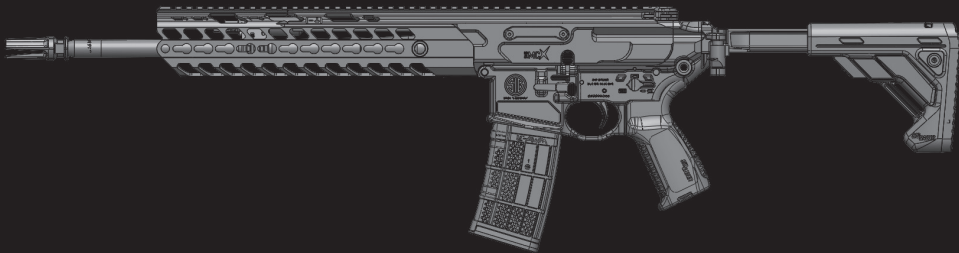

SIG MCX[®]

OWNERS MANUAL: HANDLING & SAFETY INSTRUCTIONS



**READ THE INSTRUCTIONS AND WARNINGS IN THIS MANUAL CAREFULLY
BEFORE USING THIS FIREARM; DO NOT DISCARD THIS MANUAL.**

This instruction manual should always accompany this firearm and be transferred with it upon ownership, or when the firearm is loaned or presented to another person.

State-By-State Warnings

Certain states require, by law, that their own specified warning notices, in larger-than-normal type be conspicuously included by the manufacturer, distributor, or retail dealer with firearms sold in that state. SIG SAUER sells its products in compliance with applicable laws and regulations. Because our products may be sold in these states, we include the following:

CALIFORNIA: WARNING

"Children are attracted to and can operate firearms that can cause severe injuries or death. Prevent child access by always keeping guns locked away and unloaded when not in use. If you keep a loaded firearm where a child obtains and improperly uses it, you may be fined or sent to prison."

ADVERTENCIA

"A los niños atraen las armas de fuego y las pueden hacer funcionar. Ellos pueden causarse lesiones graves y la muerte. Evite que los niños tengan acceso a las armas de fuego guardándolas siempre con llave y descargadas cuando no las esté utilizando. Si usted tiene una arma de fuego cargada en un lugar en que un niño tiene acceso a ella y la usa indebidamente, le pueden dar una multa o enviarlo a la cárcel."

CONNECTICUT:

"UNLAWFUL STORAGE OF A LOADED FIREARM MAY RESULT IN IMPRISONMENT OR FINE."

FLORIDA:

"IT IS UNLAWFUL, AND PUNISHABLE BY IMPRISONMENT AND FINE, FOR ANY ADULT TO STORE OR LEAVE A FIREARM IN ANY PLACE WITHIN THE REACH OR EASY ACCESS OF A MINOR UNDER 18 YEARS OF AGE OR TO KNOWINGLY SELL OR OTHERWISE TRANSFER OWNERSHIP OR POSSESSION OF A FIREARM TO A MINOR OR A PERSON OF UNSOUND MIND."

MAINE:

“ENDANGERING THE WELFARE OF A CHILD IS A CRIME. IF YOU LEAVE A FIREARM AND AMMUNITION WITHIN EASY ACCESS OF A CHILD, YOU MAY BE SUBJECT TO FINE, IMPRISONMENT OR BOTH. KEEP FIREARMS AND AMMUNITION SEPARATE. KEEP FIREARMS AND AMMUNITION LOCKED UP. USE TRIGGER LOCKS.”

MARYLAND:

“WARNING: Children can operate firearms which may cause death or serious injury. It is a crime to store or leave a loaded firearm in any location where an individual knew or should have known that an unsupervised minor would gain access to the firearm. Store your firearm responsibly!”

MASSACHUSETTS:

“IT IS UNLAWFUL TO STORE OR KEEP A FIREARM, RIFLE, SHOTGUN OR MACHINE GUN IN ANY PLACE UNLESS THAT WEAPON IS EQUIPPED WITH A TAMPER RESISTANT SAFETY DEVICE OR IS STORED OR KEPT IN A SECURELY LOCKED CONTAINER.”

NEW JERSEY:

“IT IS A CRIMINAL OFFENSE TO LEAVE A LOADED FIREARM WITHIN EASY ACCESS OF A MINOR.”

NEW YORK CITY, NY:

“THE USE OF A LOCKING DEVICE OR SAFETY LOCK IS ONLY ONE ASPECT OF RESPONSIBLE FIREARMS STORAGE. FOR INCREASED SAFETY, FIREARMS SHOULD BE STORED UNLOADED AND LOCKED IN A LOCATION THAT IS BOTH SEPARATE FROM THEIR AMMUNITION AND INACCESSIBLE TO CHILDREN AND OTHER UNAUTHORIZED PERSONS.”

NORTH CAROLINA:

Any person who resides in the same premises as a minor, owns or possesses a firearm, and stores or leaves the firearm (i) in a condition that the firearm can be discharged and (ii) in a manner that the person knew or should have known that an unsupervised minor would be able to gain access to the firearm, is guilty of a Class 1 misdemeanor if a minor gains access to the firearm without the lawful permission of the minor's parents or a person having charge of the minor and the minor:

- (1) Possesses it in violation of G.S. 14-269.2(b)
- (2) Exhibits it in a public place in a careless, angry, or threatening manner;
- (3) Causes personal injury or death with it not in self defense; or
- (4) Uses it in the commission of a crime.

TEXAS:

"IT IS UNLAWFUL TO STORE, TRANSPORT, OR ABANDON AN UNSECURED FIREARM IN A PLACE WHERE CHILDREN ARE LIKELY TO BE AND CAN OBTAIN ACCESS TO THE FIREARM."

WISCONSIN:

"IF YOU LEAVE A LOADED FIREARM WITHIN THE REACH OR EASY ACCESS OF A CHILD YOU MAY BE FINED OR IMPRISONED OR BOTH IF THE CHILD IMPROPERLY DISCHARGES, POSSESSES, OR EXHIBITS THE FIREARM."

Please check with your licensed retailer, state police, or local police for additional warnings, which may be required by local law or regulation. Such regulations change constantly, and local authorities are in the best position to advise you on such legal matters.

THE BASIC RULES OF SAFE FIREARMS HANDLING

1. ALWAYS treat every gun as if it were loaded.
2. ALWAYS be sure the barrel is clear of any obstruction.
3. ALWAYS be sure of your backstop, what lies beyond, and the safety of bystanders before you shoot.
4. ALWAYS use clean, dry, original factory-made ammunition of the proper type and caliber for your gun.
5. ALWAYS wear ear protection and safety glasses when shooting.
6. ALWAYS carry your gun so that you can control the direction of the muzzle if you fall or stumble.
7. NEVER shoot at a flat surface or water.
8. DO NOT leave an unattended gun loaded. Guns and ammunition should be stored separately, locked if possible, beyond the reach of children, careless adults, and unauthorized users.
9. NEVER allow your firearm to be used by anyone who has not read and understood this operator's manual.
10. DO NOT point any gun, loaded or unloaded, at any undesired target.
11. NEVER fire your rifle near an animal unless it is trained to accept the noise; an animal's startled reaction could injure it or cause an accident.
12. NEVER drink alcoholic beverages or take drugs before or during shooting, as your vision and judgment could be seriously impaired, making your gun handling unsafe.

⚠ WARNING – STORING FIREARMS

The ultimate responsibility for secure storage of any firearm must depend upon its owner and his or her individual circumstances. Firearms should be stored unloaded, in a secure location, separate from their ammunition.

FIREARMS SAFETY IS YOUR RESPONSIBILITY

This owner's manual is designed to assist you in learning how to use and care for your SIG SAUER® rifle properly.

Only when you are certain that you fully understand this manual and can properly carry out its instructions, should you practice loading and firing your firearm with live ammunition. Having a gun in your possession is a full-time job; you cannot guess and you cannot forget. You must know how to use your firearm safely.

If you have any doubts about your ability to handle or use this firearm safely, you should seek supervised instruction. The SIG SAUER AcademySM provides all levels of firearms safety and skill training, from beginner to expert. For more information contact:



www.sigsaueracademy.com • (603) 610-3400

Epping, New Hampshire

**SAFETY MUST BE THE FIRST AND CONSTANT CONSIDERATION OF
EVERY PERSON WHO HANDLES FIREARMS AND AMMUNITION.**

For more information about safety, responsible firearms ownership, and shooting sports, contact:
National Rifle Association (NRA) of America, 11250 Waples Mill Road, Fairfax, VA 22030-7400
1-800-672-3888 • www.nra.com

Operator's Manual for the SIG MCX

This manual is intended to provide the user with the information necessary to safely operate and perform authorized preventative maintenance at the user level on the SIG MCX series of rifles. Read this manual in its entirety prior to handling or operating the weapon.

WARNING

IN THIS MANUAL WARNINGS ARE INSTRUCTIONS OR INFORMATION THAT, IF IGNORED, CAN POTENTIALLY RESULT IN CATASTROPHIC MALFUNCTION OF THE WEAPON AND OR SERIOUS BODILY HARM OR DEATH.

CAUTION

IN THIS MANUAL CAUTIONS ARE INSTRUCTIONS OR INFORMATION THAT, IF IGNORED, CAN POTENTIALLY RESULT IN DAMAGE TO THE WEAPON, LOST PARTS AND OR MINOR INJURY.

⚠ WARNING

USING OR HANDLING THE SIG MCX WITHOUT FIRST READING AND UNDERSTANDING THE ENTIRE OPERATOR'S MANUAL CAN RESULT IN UNSAFE CONDITIONS WITH THE POTENTIAL TO CAUSE DEATH OR SERIOUS BODILY HARM.

- ALWAYS HANDLE AND OPERATE THE WEAPON IN ACCORDANCE WITH THE INSTRUCTIONS CONTAINED IN THIS MANUAL.
- NEVER ALLOW UNAUTHORIZED PERSONS TO HAVE ACCESS TO ANY WEAPON AND NEVER LEAVE A WEAPON UNSECURED.
- THIS MANUAL DOES NOT SUPERCEDE OR REPLACE WEAPON'S REGULATIONS, RULES, PROCEDURES OR REQUIREMENTS IN PLACE IN YOUR ORGANIZATION.
- BEFORE BEGINNING ANY MAINTENANCE BE SURE TO CLEAR THE WEAPON.
- INSPECT THE CHAMBER VISUALLY AND PHYSICALLY TO ENSURE IT IS CLEAR OF ANY AMMUNITION.
- IF THE WEAPON IS DROPPED WITH THE BOLT ASSEMBLY LOCKED TO THE REAR AND A LOADED MAGAZINE INSTALLED IT COULD CHAMBER A ROUND.
- DO NOT LOAD WITH A HOT CHAMBER.
- IF THE MCX STOPS FIRING WITH A LIVE ROUND IN THE CHAMBER OF A HOT BARREL, REMOVE IT WITHIN 10 SECONDS. IF THAT CANNOT BE ACCOMPLISHED KEEP THE MUZZLE POINTED IN A SAFE DIRECTION AND QUICKLY REMOVE THE MAGAZINE. THEN WAIT 15 MINUTES BEFORE HANDLING THE WEAPON.
- DO NOT OVER HEAT THE BARREL .
- DO NOT INTERCHANGE BOLTS BETWEEN WEAPONS.
- ENSURE THE CAM PIN IS PROPERLY INSTALLED IN THE BOLT CARRIER ASSEMBLY. SEVERE DAMAGE TO THE WEAPON AND INJURY OR DEATH TO THE OPERATOR COULD OCCUR.

TABLE OF CONTENTS

Topic	Page
State by State Warnings	2-4
The Basic Rules of Safe Firearms Handling	5
Firearms Safety	7
Warnings & Cautions.	12
General Safety Information and Mechanical Characteristics	14
1.0 Safety Information.	14
1.1 Protect Your Eyes and Ears	14
1.2 Ammunition.	15
2.0 Mechanical Characteristics and Rifle Theory	19
2.1 Rifle Description	19
2.1.1 General	19
2.2 Specifications	20
2.3 Controls and Features	26
2.3.1 MCX Pistol	28
2.4 Groups & Assemblies	29
2.4.1 Upper Receiver Group	29
2.4.2 Lower Receiver Group	33
2.5 Cycle of Operation	35
3.0 Operating the SIG MCX	38
3.1 Safety Rules & Procedures	38
3.2 Selecting Modes of Fire	40

Topic	Page
3.3 Clearing the SIG MCX	41
3.4 Loading / Reloading	44
3.5 Firing	46
3.5.1 Two Position Gas Valve	47
3.6 Adverse/Special Conditions	48
3.7 Immediate/Remedial Action	50
3.8 MCX Stock Variants	51
4.0 User Level Authorized Preventive Maintenance	57
4.1 Field Strip the SIG MCX	57
5.1 Cleaning and Lubrication	65
5.2 Lubrication	70
5.3 Reassembly	70
5.4 Function Check	77
5.5 Troubleshooting	78
5.6 Upper Receiver Assembly Parts Diagram	80
5.7 Upper Receiver Assembly Parts List	81
5.8 Lower Receiver Assembly Parts Diagram	82
5.9 Lower Receiver Assembly Parts List	83
6.0 Transportation and Storage	84
7.0 Service and Replacement Parts Policy	86
8.0 Shipping Firearms for Repair	88
SIG SAUER® Limited Lifetime Firearms Warranty	90

WARNINGS OF GREAT IMPORTANCE ARE FOUND WITHIN THIS MANUAL

Storing Firearms	6	Safety	43
Alterations	13	Storage	84
Ammunition	15, 18	Parts Purchasers	87
Lead Exposure	18		

OTHER CAUTIONS AND WARNINGS APPEAR THROUGHOUT THE MANUAL

FIREARMS ARE DANGEROUS WEAPONS

**READ THE INSTRUCTIONS AND WARNINGS IN THIS MANUAL
THOROUGHLY AND CAREFULLY BEFORE USING.**

⚠ WARNING – ALTERATIONS

This product was designed to function properly in its original condition. Alterations can make it unsafe. Do not alter any part or add or substitute any parts or accessories not manufactured by SIG SAUER Inc. to be compatible for this product.

DO NOT ALTER ANY FIREARM

GENERAL SAFETY INFORMATION AND MECHANICAL CHARACTERISTICS

1.0 Safety Information

The safety warnings in this manual are important. By understanding the dangers inherent in the use of any firearm, and by taking the precautions described herein, you can enjoy increased safety in the use of your rifle. Failure to heed any of these warnings may result in serious injury to you or others, as well as severe damage to the firearm or other property. SIG SAUER Inc. shall not be responsible in any manner whatsoever for malfunctioning of the firearm, physical injury or property damage resulting in whole or in part from:

- 1) criminal or negligent discharge;
- 2) improper or careless handling;
- 3) unauthorized modifications;
- 4) defective, improper, hand-loaded, or reloaded ammunition;
- 5) corrosion;
- 6) neglect; or
- 7) other influences beyond our direct and immediate control.

This limitation applies regardless of whether liability is asserted on the basis of contract, negligence, or strict liability (including any failure to warn). Under no circumstance shall SIG SAUER Inc. be liable for incidental or consequential damages, such as loss of use of property, commercial loss, and loss of earnings or profits.

1.1 Protect Your Eyes And Ears

Always wear safety glasses and ear plugs or “ earmuff ” type protectors whenever you are shooting. Always make certain that persons close to you are similarly protected. Unprotected eyes may be injured by powder, gas, carbon residue,

lubricant, metallic particles, or similar debris which may emanate occasionally from any firearm in normal use. Without ear protection, repeated exposure to shooting noise may lead to cumulative, permanent hearing loss.

1.2 Ammunition

1. Use only high quality, original, factory-manufactured ammunition. Do not use cartridges that are dirty, wet, corroded, bent, or damaged. Do not oil cartridges. Do not spray aerosol-type lubricants, preservative, or cleaners directly onto cartridges or where excess spray may flow into contact with cartridges. Lubricant or other foreign matter on cartridges can cause potentially dangerous ammunition malfunctions. Use only ammunition of the caliber for which your firearm is chambered. The proper caliber is permanently engraved on your firearm; never attempt to use ammunition of any other caliber.
2. The use of reloaded, "remanufactured" hand-loaded, or other non-standard ammunition voids all warranties. Reloading is a science and improperly loaded ammunition can be extremely dangerous. Severe damage to the firearm and serious injury to the shooter or to others may result. Always use ammunition that complies with the industry performance standards established by the Sporting Arms and Ammunition Manufacturers' Institute, Inc. of the United States (SAAMI) or ammunition manufactured to military specifications.

⚠ WARNING – AMMUNITION (CARTRIDGE) NOTICE

SIG SAUER Inc. SPECIFICALLY DISCLAIMS RESPONSIBILITY FOR ANY DAMAGE OR INJURY WHATSOEVER OCCURRING IN CONNECTION WITH, OR AS A RESULT OF, THE USE IN ANY SIG SAUER FIREARM OF FAULTY, NON-STANDARD, "REMANUFACTURED" HAND LOADED (RELOADED) AMMUNITION, OR CARTRIDGES OTHER THAN THOSE FOR WHICH THE FIREARM WAS ORIGINALLY CHAMBERED.

3. Firearms may be severely damaged and serious injury to the shooter or to others may result from any condition causing excessive pressure inside the chamber or barrel during firing. Excessive pressure can be caused by obstructions in the barrel, propellant powder overloads, the use of incorrect cartridges or defectively assembled cartridges. In addition, the use of a dirty, corroded, or damaged cartridge can lead to a burst cartridge case and consequent damage to the firearm and personal injury from the sudden escape of high-pressure propellant gas within the firearm's mechanism.

4. Immediately stop shooting and check the barrel for a possible obstruction whenever:

- You have difficulty in, or feel unusual resistance in, chambering a cartridge;
- A cartridge misfires (does not go off);
- The mechanism fails to extract a fired cartridge case;
- Unburned grains of propellant powder are discovered spilled in the mechanism;
- A shot sounds weak or abnormal. In such cases it is possible that a bullet is lodged part way down the barrel.
- Firing a subsequent bullet into the obstructed barrel can damage the firearm and cause serious injury to the shooter or to bystanders.

5. Bullets can become lodged in the barrel:

- If the cartridge has been improperly loaded without propellant powder, or if the powder fails to ignite (ignition of the cartridge primer alone will push the bullet out of the cartridge case, but usually does not generate sufficient energy to expel the bullet completely from the barrel);
- If the bullet is not properly seated in the cartridge case. When such a cartridge is extracted from the chamber without being fired, the bullet may be left behind in the bore at the point where the rifling begins. Subsequent chambering of another cartridge may push the first bullet further into the bore.

6. If there is any reason to suspect that a bullet is obstructing the barrel, immediately unload the firearm and look through

the bore. It is not sufficient to merely look in the chamber. A bullet may be lodged some distance down the barrel where it cannot easily be seen.

IF A BULLET IS IN THE BORE, DO NOT ATTEMPT TO SHOOT IT OUT BY USING ANOTHER CARTRIDGE OR BY BLOWING IT OUT WITH A BLANK OR ONE FROM WHICH THE BULLET HAS BEEN REMOVED. SUCH TECHNIQUES CAN GENERATE EXCESSIVE PRESSURE, WRECK THE FIREARM, AND CAUSE SERIOUS PERSONAL INJURY.

If the bullet can be removed with a cleaning rod, clean any unburned powder grains from the bore, chamber, and mechanism before resuming shooting. If the bullet cannot be dislodged by tapping it with a cleaning rod, take the firearm to a gunsmith.

7. Dirt, corrosion, or other foreign matter on a cartridge can impede complete chambering and may cause the cartridge case to burst upon firing. A damaged or deformed cartridge may also impede chambering performance and cause the cartridge case to burst upon firing.

8. Do not oil cartridges, and be sure to wipe the chamber clean of any oil or preservative before shooting. Oil interferes with the friction between cartridge case and chamber wall that is necessary for safe functioning, and subjects the firearm to stress similar to that imposed by excessive pressure.

9. Use lubricants sparingly on the moving parts of your firearm. Avoid excessive spraying of any aerosol gun care product, especially where it may get on ammunition. All lubricants and aerosol spray lubricants in particular can penetrate cartridge primers and cause misfires. Some highly penetrative lubricants can also migrate inside cartridge cases and cause deterioration of the propellant powder; on firing, the powder may not ignite. If only the primer ignites, there is danger that the bullet may become lodged in the barrel.

⚠ WARNING – AMMUNITION



Death, serious injury, and damage can result from the use of wrong ammunition, bore obstructions, powder overloads, or incorrect cartridge components. Always wear shooting glasses and hearing protectors.

IMPROPER AMMUNITION DESTROYS FIREARMS

⚠ WARNING – LEAD EXPOSURE



Discharging firearms in poorly ventilated areas, cleaning firearms, or handling ammunition may result in exposure to lead and other substances known to the state of California to cause birth defects, reproductive harm, and other serious physical injury. Maintain adequate ventilation at all times. Wash hands thoroughly after exposure.

SHOOTING OR CLEANING FIREARMS MAY EXPOSE YOU TO LEAD

2.0 Mechanical Characteristics and Rifle Theory

2.1 Rifle Description

2.1.1 General

The SIG MCX is a magazine fed, gas operated rifle available in 5.56x45mm NATO, and 7.62x35mm (.300 AAC Blackout) calibers. The SIG MCX fires from a rotating locking closed bolt. The SIG MCX is available in semi-automatic and select fire rifle variants, as well as a pistol version. The operating system is a short stroke piston system enabling optimum function under adverse conditions. The MCX is fitted with an aluminum handguard which provides KeyMod mounting interfaces for accessories at the 3-6-9 clock positions. There are several sling attachment points provided. SIG offers the MCX with a variety of stock configurations making the MCX adaptable to any shooter. Stock variants include Folding, Folding Telescopic, Collapsible, and a Light Weight Folding option. The SIG MCX Pistol is fitted with the SIG SAUER Pistol Stabilizing Brace.

2.2 Specifications

		MCX PDW
CALIBERS		5.56mm NATO 7.62x35mm (.300 BLK)
O.A.L LT WGT FOLDING MIN/MAX	5.56 NATO .300 BLK .300 BLK	9.0" BBL – 19.6"(487.8mm) 28.5"(723.9mm) 6.75" BBL – 21.4"(543.5mm) 30.25"(768.3mm) 9.0" BBL – 19.6"(487.8mm) 28.5"(723.9mm)
O.A.L. FOLDING PISTOL STABILIZING BRACE		
BARREL LENGTH	5.56 NATO .300 BLK .300 BLK	9.0"(228.6mm) 6.75" (171.45mm) 9.0" (228.6mm)
BARREL TWIST RATE	5.56 NATO .300 BLK	1:7 (177mm) 1:6 (152mm)
BARREL THREAD (Muzzle)	5.56 NATO .300 BLK	1/2x28 5/8x24
WEIGHT, LT WGT FOLDING	5.56 NATO .300 BLK .300 BLK	5.8 lbs. (2.6kg) 6.75" BBL 5.8 lbs. (2.6kg) 9.0" BBL 5.5 lbs. (2.5kg)

MCX CQB	MCX TACTICAL PATROL	MCX PATROL	MCX PISTOL
5.56mm NATO 7.62x35mm (.300 BLK)	5.56mm NATO 7.62x35mm (.300 BLK)	5.56mm NATO 7.62x35mm (.300 BLK)	5.56mm NATO 7.62x35mm (.300 BLK)
22.1" (561.3mm) 31.0" (787.4m)	25.1"(637.5mm) 34.0"(863.6mm)	26.6" (675.6mm) 35.5"(902mm)	N/A
			19.5"(105.3mm) 28.0"(711.2mm)
11.5" (282.1mm)	14.5" (368.3mm)	16.0"(406.40mm)	9.0"(228.6mm)
1:7 (152mm)	1:7 (177mm) 1:6 (152mm)	1:7 (177mm) 1:6 (152mm)	1:7 (177mm) 1:6 (152mm)
1/2x28 5/8x24	1/2x28 5/8x24	1/2x28 5/8x24	1/2x28 5/8x24
6.0 lbs.(2.72kg)	6.5 lbs. (2.95kg)	6.9 lbs. (3.13kg)	N/A

2.2 Specifications (continued)

	MCX PDW
WEIGHT, FOLDING PISTOL STABILIZING BRACE	
HEIGHT	7.5"(192mm)
MIL-STD 1913 RAIL LENGTH UPPER RECEIVER	15.1"(385mm)
MIL-STD 1913 ACCESSORY RAIL LENGTH	2.0" (50.8mm) 4.0" (102mm)
TRIGGER TYPE	MIL-STD
TRIGGER WEIGHT	5.5 lbs. (24.5N) - 9.0 lbs. (40.03N)
FORWARD ASSIST	YES
CHARGING HANDLE	AMBIDEXTROUS
HANDGUARD	ALUMINUM KeyMod
FIRE CONTROL SELECTOR	AMBIDEXTROUS
BOLT CATCH	MIL-STD
SIGHTS	MECHANICAL FLIP UP

MCX CQB	MCX TACTICAL PATROL	MCX PATROL	MCX PISTOL
			.300 BLK 5.6lbs(2.54kg)
7.5"(192mm)	7.5"(192mm)	7.5"(192mm)	7.5"(192mm)
15.1"(385mm)	15.1"(385mm)	15.1"(385mm)	15.1"(385mm)
2.0" (50.8mm) 4.0" (102mm)	2.0" (50.8mm) 4.0" (102mm)	2.0" (50.8mm) 4.0" (102mm)	2.0" (50.8mm) 4.0" (102mm)
MIL-STD	MIL-STD	MIL-STD	MIL-STD
5.5 lbs. (24.5N) - 9.0 lbs. (40.03N)	5.5 lbs. (24.5N) - 9.0 lbs. (40.03N)	5.5 lbs. (24.5N) - 9.0 lbs. (40.03N)	5.5 lbs. (24.5N) - 9.0 lbs. (40.03N)
YES	YES	YES	YES
AMBIDEXTROUS	AMBIDEXTROUS	AMBIDEXTROUS	AMBIDEXTROUS
ALUMINUM KeyMod	ALUMINUM KeyMod	ALUMINUM KeyMod	ALUMINUM KeyMod
AMBIDEXTROUS	AMBIDEXTROUS	AMBIDEXTROUS	AMBIDEXTROUS
MIL-STD	MIL-STD	MIL-STD	MIL-STD
MECHANICAL FLIP UP	MECHANICAL FLIP UP	MECHANICAL FLIP UP	MECHANICAL FLIP UP

2.2 Specifications (continued)

	MCX PDW
SLING ATTACHMENT POINTS	MULTIPLE QD LOCATIONS
RECOIL PADS-LT WGT FOLDING	3/8" (95.25mm) 1.0" (25.4mm)
FIRE CONTROL TYPE	SEMI-AUTO OR SELECT FIRE

MCX CQB	MCX TACTICAL PATROL	MCX PATROL	MCX PISTOL
MULTIPLE QD LOCATIONS	MULTIPLE QD LOCATIONS	MULTIPLE QD LOCATIONS	MULTIPLE QD LOCATIONS
3/8" (95.25mm) 1.0" (25.4mm)	3/8" (95.25mm) 1.0" (25.4mm)	3/8" (95.25mm) 1.0" (25.4mm)	N/A
SEMI-AUTO OR SELECT FIRE	SEMI-AUTO OR SELECT FIRE	SEMI-AUTO OR SELECT FIRE	SEMI AUTO ONLY

2.3 Controls & Features

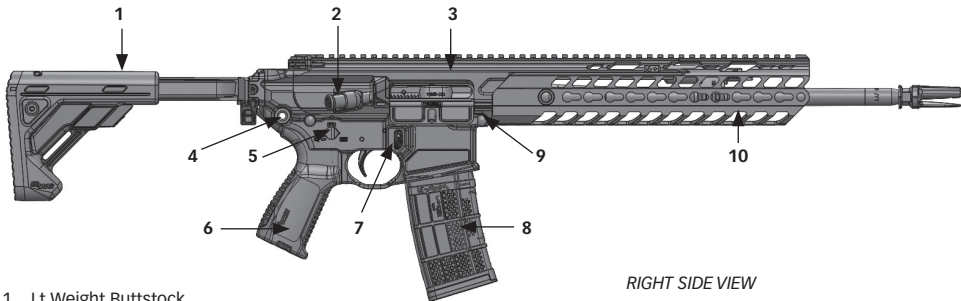

RIGHT SIDE VIEW

- 1 Lt Weight Buttstock
- 2 Forward Assist
- 3 Upper Receiver
- 4 QD Sling Cup
- 5 Ambi-Fire Control Selector
- 6 Pistol Grip
- 7 Magazine Release Button
- 8 Magazine
- 9 Front Pivot Pin
- 10 KeyMod Handguard

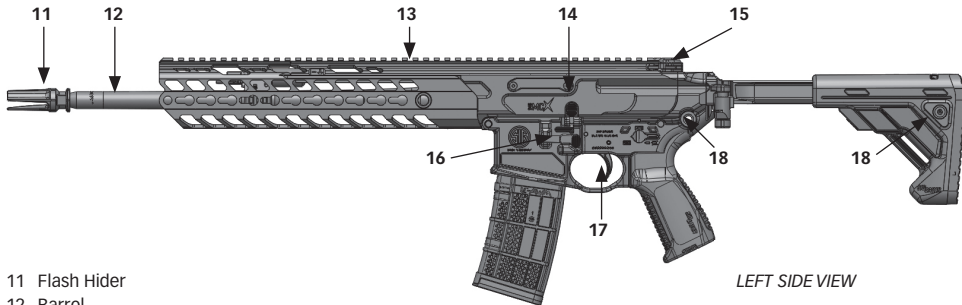

- 11 Flash Hider
- 12 Barrel
- 13 Full Length Mil-Std 1913 Rail
- 14 Bolt Catch
- 15 Charging Handle
- 16 Ambidextrous Magazine Catch
- 17 Trigger
- 18 QD Sling Cup

LEFT SIDE VIEW

2.3.1 MCX Pistol



2.4 Groups & Assemblies

2.4.1 Upper Receiver Group

The upper receiver group consists of the following:

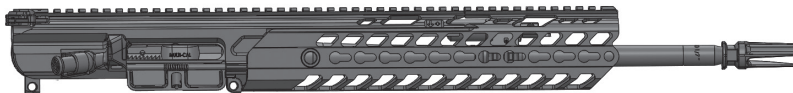

a) Ambidextrous Charging Handle Assembly

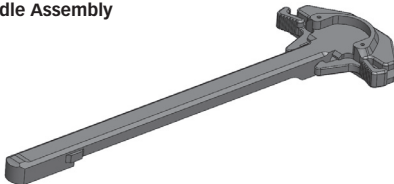

"U.S. patent Nos. 7,900,546 and 7,240,600 under license"

b) MCX Carriage Assembly

The SIG MCX operating system differs from common M16/M4 type systems. The recoil system eliminates the need for a conventional buffer and receiver extension. The result is the ability to utilize folding and collapsible stocks. The carriage assembly pictured below is removed as a single unit during field stripping and maintenance by the operator.

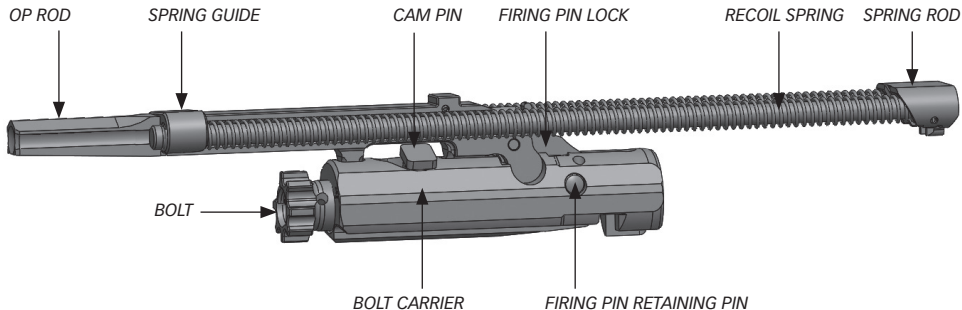

c) Barrel Assembly

The SIG MCX barrel assembly is comprised of the barrel extension, the barrel, gas block, gas valve, gas piston, and the flash hider.

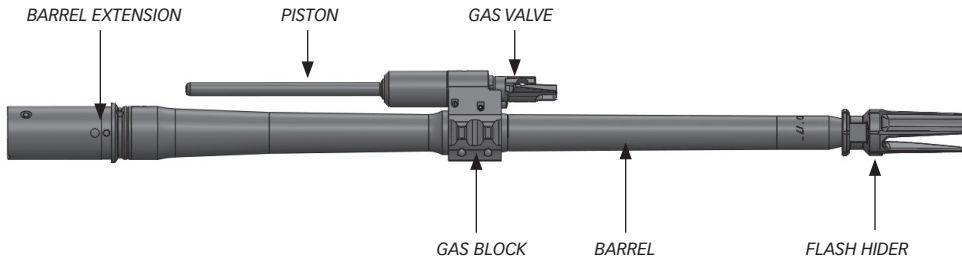

**Flash Hider may differ from you actual weapon system.

d) Handguard Assembly

The SIG MCX handguard assembly is comprised of the handguard and the handguard link. There is a short PDW version and a rifle length version. The handguard features multiple points for mounting Mil-Std 1913 rail segments.

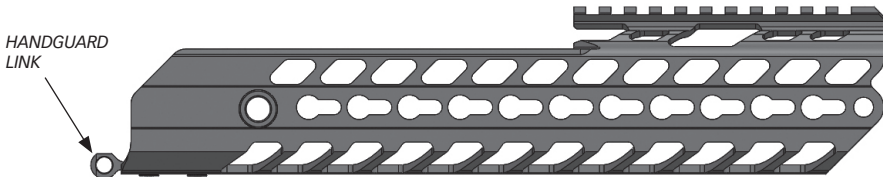

⚠ WARNING

Due to the modularity of the MCX, you must make sure that when reconfiguring the rifle by changing barrels and handguards, the flash hider, muzzle brake, or suppressor must be exposed from the end of the handguard. Failure to do so could result in injury to the operator and or damage to the rifle.

2.4.2 Lower Receiver Group

The Lower Receiver Group consists of the following assemblies: Lower Receiver Assembly with Fire Control Components, Buttstock Assembly, and Grip Assembly.

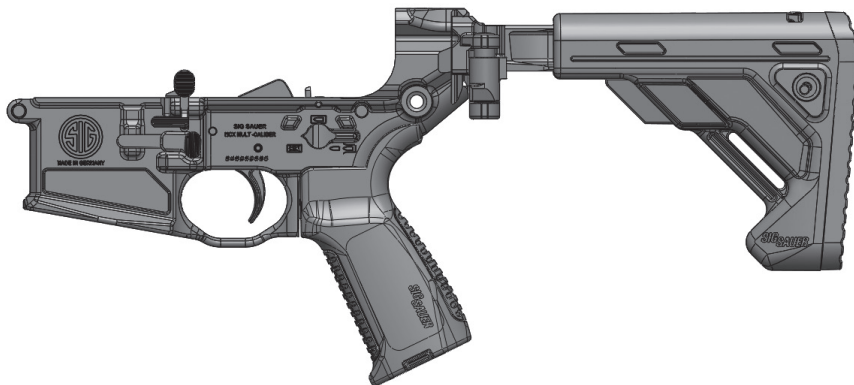

a. Lower Receiver Assembly

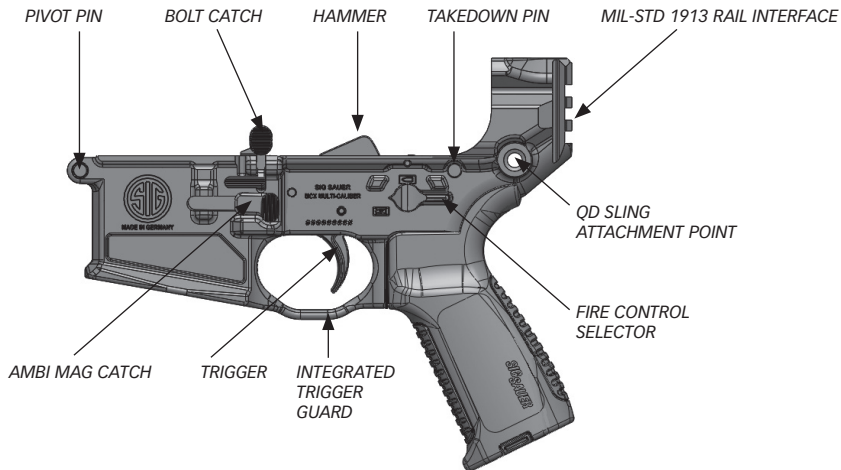

2.5 Cycle of Operation

There are eight steps in the cycle of operation of the SIG MCX which begin after a loaded magazine is inserted into the weapon.

FEEDING

As the bolt carrier is released from its rearward position, the carrier group moves forward allowing the lower lugs of the bolt to make contact with the rear of the cartridge as it sits in the magazine.

The cartridge is stripped from the magazine and begins its forward movement toward the chamber.

CHAMBERING

As the bolt moves forward the bolt locking lugs move forward into the barrel extension. The ejector is then compressed against the left side of the cartridge head.

The last action that occurs is the ejector snapping over the rim of the cartridge case.

LOCKING

The movement of the bolt and the cartridge is stopped by the chamber.

The bolt carrier continues to move forward until it is stopped by contact with the rear face of the barrel extension.

As the carrier goes through the last portion of movement, the bolt is rotated to the left, through the action of the cam slot in the carrier and the cam pin through the bolt.

This engages the bolt lugs with the barrel extension lugs to lock the bolt into the barrel extension.

FIRING

The selector is rotated to the Semi position.

The trigger is pressed and the hammer is released. The hammer spring drives the hammer forward unlocking the firing pin. The firing pin strikes the cartridge primer, causing detonation.

UNLOCKING

As the bullet passes the gas port in the barrel, a small amount of gas is bled off travelling up through the gas port and into the gas block. The gas is regulated by the gas valve and is based on the type of ammunition being fired. This gas acts upon the piston to move the operating rod to the rear. The operating rod transfers its energy to the carrier assembly setting it in motion. The rearward movement of the carrier caused the bolt cam pin to rotate the bolt to the unlocked position.

EXTRACTION

As the bolt carrier assembly moves rearward the spent case is pulled free from the chamber by the extractor. The twisting motion of the bolt aids in the extraction from the chamber.

EJECTION

The extractor continues to grip the rim of the spent case on the right side. The ejector is applying forward pressure to the left side of the case. As the expended case clears the chamber, then the barrel extension, it is flipped out through the ejector port on the right side of the receiver.

COCKING

The rearward movement of the bolt carrier overrides the hammer, forcing it down into the receiver and compressing the hammer spring, cocking the hammer in the firing position.

3.0 Operating the SIG MCX

3.1 Safety Rules & Procedures

Always follow the safety rules and procedures noted in this manual in addition to the safety rules, regulations, procedures or guidelines of your organization.

3.1.1 Safety Rules

- a. Treat every weapon as if it were loaded.
- b. Never point a weapon at anything you do not intend to shoot.
- c. Keep your trigger finger off the trigger and out of the trigger guard until you are ready to shoot.
- d. Keep the weapon on safe until you are ready to shoot.
- e. Be sure of your intended target and know what lies beyond.

3.1.2 Safety Procedures

- a. When handing a weapon to someone else or prior to accepting a weapon from another person, always physically and visually check the chamber so both people can ensure the weapon is unloaded.
- b. Every SIG SAUER firearm is shipped with a chamber safety flag. The chamber safety flag prevents the chambering of a round when installed and provides a readily visible indication that the weapon's chamber is empty. The chamber safety flag is to be installed in the weapon's chamber at all times when not actually on the firing range.
- c. Ensure that unauthorized people never have access to a firearm. Never operate or handle a weapon when you are under the influence of alcohol or drugs.
- d. Be aware of where the muzzle of the weapon is pointed at all times while handling or operating the weapon. Never allow the muzzle to be inadvertently pointed at another person.
- e. Always perform a functions check prior to shooting the weapon (see paragraph 3.5). Do not fire the weapon if it is damaged or it fails functions check.
- f. Always use serviceable, clean ammunition that complies with Sporting Arms and Ammunition Manufacturers' Institute, Inc. (SAAMI) or manufactured to U.S. military or NATO STANAG specification of the proper caliber for the weapon. Never oil or otherwise lubricate ammunition. Do not use damaged or dented ammunition.
- g. Do not fire the weapon if you had a known baffle strike in the suppressor as this can cause a catastrophic failure to the suppressor or injury to the shooter or bystander should another baffle strike occur.

- h. Live fire weapon's training should always be conducted on an approved firing range conforming to the minimum safety requirements for the caliber and ammunition utilized and under the supervision of qualified range safety personnel.
- i. Always ensure weapons are unloaded prior to storage, maintenance or otherwise not in use.
- j. Any maintenance beyond the user level described in this manual is to be performed by qualified personnel specific trained on the maintenance of the SIG MCX in accordance with the SIG Sauer armorer's manual for this weapon

3.2 Selecting Modes of Fire

The SIG MCX is available in two fire control configurations. SAFE-SEMI and SAFE-SEMI-AUTO. Modes of fire are selected by rotating the selector lever to the desired position. The SAFE position prevents the weapon from firing by blocking the action of the trigger. The SEMI position is for the semi-automatic mode and allows the firing of one round each time the trigger is depressed. AUTO, if so equipped, allows for a continuous rate of fire until the trigger is released by the operator, or the magazine is depleted of ammunition.

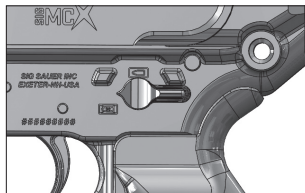

SAFE

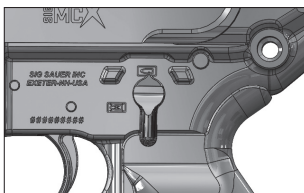

SEMI



AUTO

3.3 Clearing the SIG MCX

1. Ensure the muzzle of the weapon is pointed in a safe direction at all times while clearing the weapon.
2. Remove the magazine from the weapon by depressing the magazine catch with the index finger of the firing hand and simultaneously pulling the magazine free with the support hand.

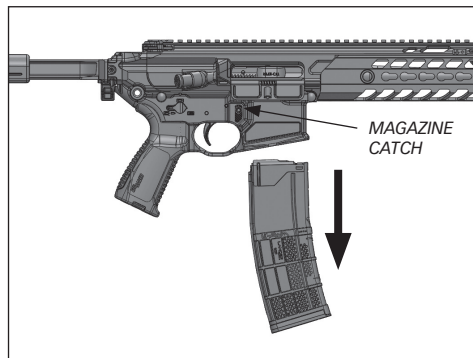
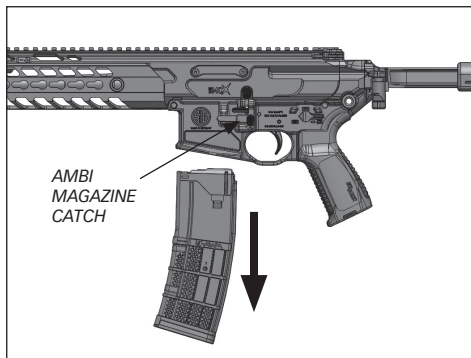

3. With the support hand depress and hold the bottom portion of the bolt catch (see diagram B). while pulling the charging handle briskly and fully to the rear with the firing hand. Engage the bolt catch ensuring that the bolt carrier assembly remains locked to the rear and return the charging handle to its forward and locked position. Ensure the weapon is on safe.

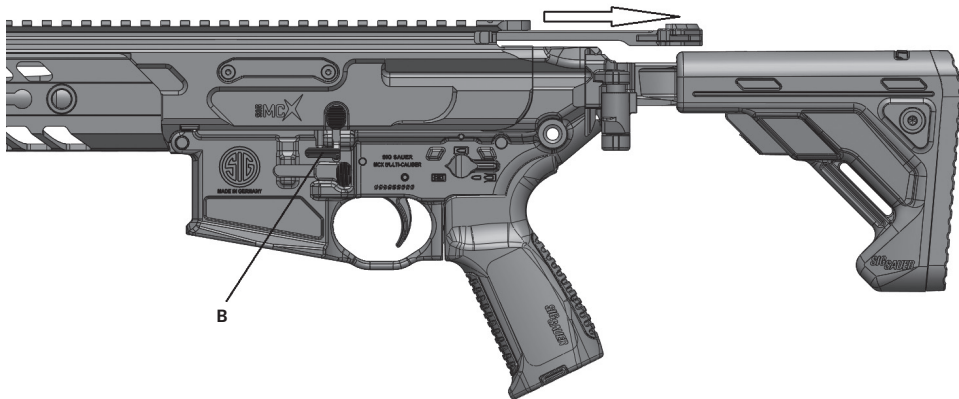

4. Inspect the chamber to ensure that there are no live rounds or spent cartridges present. In periods of darkness or reduced visibility it will be necessary to physically inspect the chamber.

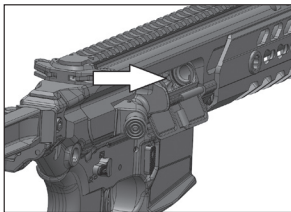

⚠ CAUTION – SAFETY

THE BOLT CARRIER ASSEMBLY IS UNDER SPRING TENSION AND WILL SPRING FORWARD IF THE BOLT CATCH IS INADVERTENTLY DEPRESSED POSSIBLY CAUSING INJURY. DO NOT TO ALLOW THE BOLT CATCH TO BE DEPRESSED. THE CHAMBER OF THE WEAPON COULD POTENTIALLY BE HOT CAUSING BURNS. WHEN PHYSICALLY INSPECTING THE CHAMBER, USE A PEN OR SIMILAR IMPLEMENT IF YOU ARE NOT SURE THE CHAMBER IS COLD.

5. If passing the weapon to another authorized operator allow that person to inspect the chamber prior to relinquishing the weapon. Pass the weapon with the bolt locked to the rear and the fire control selector on SAFE.

3.4 Loading / Reloading

3.4.1 Loading/Bolt locked to the rear

1. Grasp and retract the charging handle locking the bolt carrier to the rear by pressing the bolt catch inward (see diagram 6).
2. Return the charging handle to the forward locked position.
3. Rotate the fire control selector to the SAFE position.
4. Visually and physically inspect the chamber to ensure it is clear.
5. Insert a loaded magazine until it engages and is held by the magazine catch. Always pull down to ensure the magazine is seated properly.
6. Press the top of the bolt catch inward releasing the bolt carrier (see diagram 6). If the weapon is not to be fired immediately, close the ejection port cover.

3.4.2 Loading/Bolt forward

1. Insert a loaded magazine until it engages and is held by the magazine catch. Always pull down to ensure the magazine is seated properly.
2. Grasp the charging handle and pull it completely to the rear.
3. Release the charging handle allowing it to go forward under full spring pressure (DO NOT RIDE IT FORWARD).
4. Rotate the fire control selector to SAFE.

3.4.3 Reloading an expended magazine (Bolt locked to rear)

1. Rotate the fire control selector to SAFE.
2. Depress the magazine catch from either the left or right side. The magazine should fall free from the mag well.
3. Insert a loaded magazine until it engages and is held in place by the magazine catch. Pull down to ensure proper seating of the magazine.
4. Depress the top of the bolt catch releasing the bolt carrier forward chambering a live cartridge.

3.4.4 Reloading a partially expended magazine (bolt forward, live round chambered)

1. Rotate the fire control selector to SAFE.
2. Grasp the magazine with the support hand and depress the magazine catch from either the left or right side.
3. Remove the partially loaded magazine and secure it.
4. Insert a loaded magazine until it engages and is held in place by the magazine catch. Pull down to ensure proper seating of the magazine.

3.5 Firing

SEMI: When the fire control selector is rotated to this position one press of the trigger will result in a single round being fired.

AUTO: When the fire control selector is rotated to this position, pressing the trigger will result in continuous fire at the cyclic rate until the shooter releases the trigger or the magazine is depleted of ammunition.

To fire the SIG MCX:

1. Deploy the buttstock if not already done.
2. Insert a loaded magazine into the SIG MCX.
3. Face the target, placing the weapon on your shoulder.
4. Rotate the fire control selector from SAFE to SEMI or AUTO.
5. Pressing the trigger releases the hammer causing the cartridge to be fired.

3.5.1 Two Position Gas Valve

The SIG MCX is equipped with a two position gas valve. This gas valve assembly regulates the function of the MCX by metering the amount of gas that is required for the weapon to function. This valve allows for suppressed and unsuppressed operation. The adjustment is made by pushing the lever down on the appropriate side of the handguard.

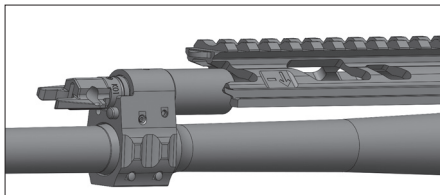

HANDGUARD REMOVED FOR CLARITY

Application	Marking	
	-	+
300BLK Suppressed Only	Supersonic	Sub-Sonic
5.56 Suppressed Only	Normal	Adverse
Suppressed/Unsuppressed	Suppressed	Unsuppressed
Unsuppressed Only	Normal	Adverse

3.6 Adverse/Special Conditions

Desert

- Apply light lubrication to internal metal on metal moving parts only. If available use dry graphite lubricant.
- Increase frequency of inspection and cleaning of weapon due to blowing dust and sand. Use muzzle covers if available.
- Unload and clean ammunition and inside of magazines daily. Do not lube magazines.
- Cover weapons when not in use.
- Close the ejection port cover when not in use.

Arctic

- When operating in sub-freezing temperatures lubricate with LAW. Do not use CLP as it can prevent the weapon from firing.
- Avoid bringing weapon into heated shelters and buildings to prevent condensation from forming on moving parts which will freeze when the weapon is brought back outdoors.
- If necessary to bring weapon indoors allow it to warm to room temperature then disassemble and clean thoroughly ensuring all moisture is removed from weapon and re-lubricate with LAW.
- When operating in snowy environments conduct frequent inspection of the weapon to ensure snow has not gotten into operating parts. Work the action to ensure it is not frozen. Use muzzle covers if available.
- If the bolt carrier becomes frozen with snow/moisture DO NOT fire weapon to free the bolt carrier. Warm weapon with body heat or bring indoors until free movement is restored then clean & re-lubricate weapon.

Jungle

- Increase frequency of inspection and cleaning of the weapon for rust/ corrosion.
- Apply thin coat of lubricant on steel parts frequently.
- Inspect hidden surfaces of the bolt and carrier assembly, upper receiver and chamber/barrel extension (locking lugs)
- Inspect the lower receiver for corrosion.
- Inspect and lubricate the spring-loaded detents on the weapon.
- Unload magazine, clean ammunition, and inspect inside of magazines daily for corrosion.
- Wipe ammunition dry before reloading.

3.7 Immediate/Remedial Action

If the SIG MCX stops firing:

1. Slap up on the bottom of the magazine.
2. Pull charging completely rearward.
3. Observe the ejection of the case/cartridge and check the chamber for any obstruction.
4. Release the charging handle to feed a new cartridge.
5. Tap the forward assist to ensure the round is chambered and the bolt is locked.
6. Press the trigger and attempt to fire the weapon.

If the SIG MCX still fails to fire upon completion of above steps:

1. Check the chamber for a stuck case.
2. If a case is present separate the receivers and remove the bolt carrier and op rod assembly.
3. Attempt to tap out the case with a cleaning rod from the muzzle end of the barrel.
If the weapon still fails to fire refer to the troubleshooting section of this manual.

3.8 MCX Stock Variants

SIG SAUER offers several buttstocks for the MCX series of rifles. All are designed to attach to the Mil-Std 1913 interface on the lower receiver.

3.8.1 Five Position Folding /Telescoping Stock

There are five positions of length adjustment on the stock. To adjust the length of the stock, press in on the serrated stock key. This will allow the latch to unlock. The stock can now be moved to the desired position. The stock key is protected by the latch to keep the stock from inadvertently being unlatched during firing. Once the stock is at the desired length, release the stock key and manipulate the stock forward and backward to ensure it is securely engaged in the desired position.

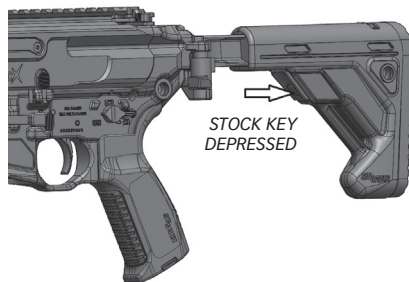
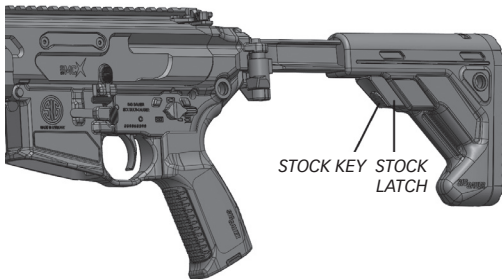

3.8.2 Lightweight (Thin) Folding Stock

The MCX light weight folding stock offers the user the option of installing a lightweight (thin) folding stock for ease of transport.



LIGHTWEIGHT STOCK

Fig A shows the hinge engaged.

To fold the stock you must lift up on the stock itself as shown in Fig B.

This will disengage the hinge. The stock can then be folded to the left. To deploy the stock you simply grab the end of the stock and pull it away from the receiver swinging it rearward. The stock hinge will engage and lock into place as shown in Fig A.

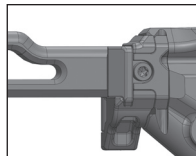

FIGURE A

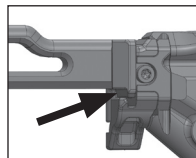

FIGURE B

3.8.3 Left Side Folding Telescoping (M4 type) Stock:

This left side folding stock provides the same features as the previously detailed folding stock but with the added ability to telescope the buttstock to the desired length of pull for the operator.

This configuration allows the use of most M4 type buttstocks that will fit Mil-Spec diameter receiver extensions.



The stock assembly consists of the folding knuckle assembly and the receiver extension. User supplies buttstock.

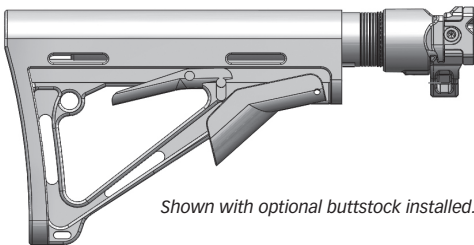

Shown with optional buttstock installed.

3.8.4 Collapsible Stock:

The collapsible stock provides the operator the ability to reduce the overall length of the SIG MCX. By pressing the release button the stock can be extended or collapsed to one of the two stop positions. The stop positions are located at the 2" and 4" length of pull location. The SIG MCX can be fired with the stock in the collapsed position.



STOCK FULLY EXTENDED



STOCK FULLY COLLAPSED

Collapsible Stock Installation/Removal.

1. Press the release button and completely extend the buttstock.
2. Using a Torx 25 wrench, loosen and remove the rail clamp.
3. Slide the stock mount onto the Mil-Std 1913 rail at the rear of the SIG MCX lower receiver.
4. Reinstall the clamp and tighten the screw snug plus $\frac{1}{4}$ turn.
5. Check the function of the stock by collapsing it to both stop points and then completely collapse the stock.



Recoil Pad/Extender Installation

The SIG MCX stock gives the operator the ability to extend the length of pull by the addition of a 3/8" or 1.0" recoil pad. Align the vertical tab of the recoil pad or adapter and slide it upward until the tab engages the tab slot.

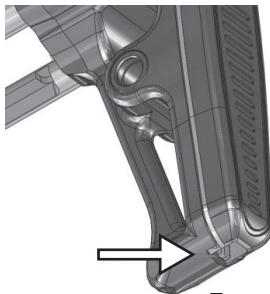

Recoil Pad/Extender Removal

To remove, insert the tip of a cartridge into the tab slot and pull down. These components fit both collapsible and both folding stock variant



3.8.5 Folding Stock Installation/Removal

All SIG MCX folding stocks use the same folding knuckle. The following instructions apply to all folding stocks.

1. Loosen the rail clamp screw with a Torx 25 wrench.
2. Rotate the folding knuckle onto the Mil-Std 1913 rail at the desired height.
3. Tighten the screw until snug plus 1/4 turn.
4. Check the folding function as described in 3.8.1.

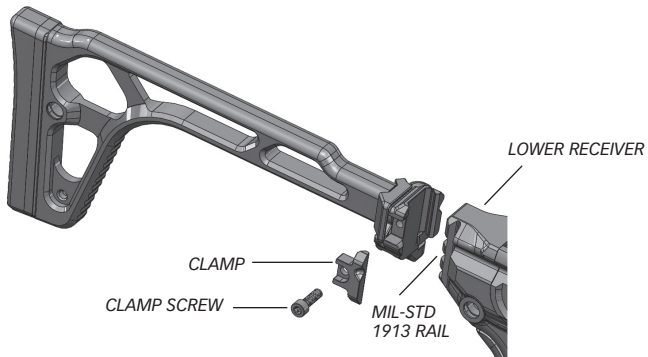

4.0 User Level Authorized Preventive Maintenance

4.1 Field Strip the SIG MCX

1. Clear the weapon and rotate selector to SAFE.
2. Remove the sling if attached.
3. Push the takedown pin from left to right until stopped by the detent.
4. Swing apart the receivers.

**With the collapsible stock installed, you must extend the stock to its longest position prior to separating the receivers.

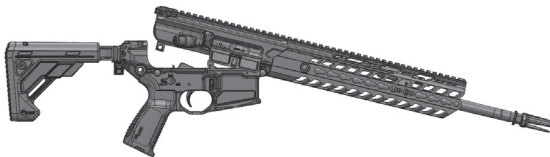
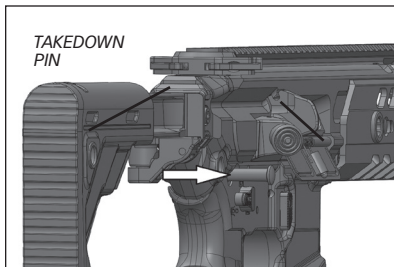

5. Retract the charging handle until it stops.

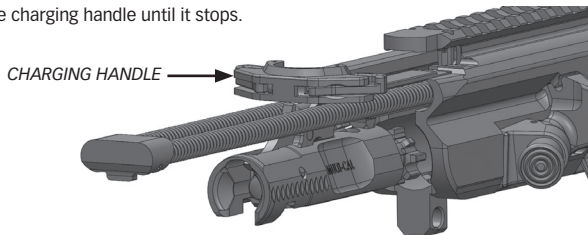

6. Grasp the recoil spring plate and pull the carriage assembly from the upper receiver. It will come out as a complete unit.

7. Remove the charging handle.

8. Close the receivers together and push the pivot pin from left to right and separate the receivers.

9. Push the firing pin lock pivot pin from left to right and lift the firing pin lock from the bolt carrier.

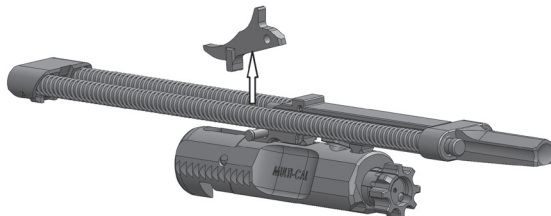

10. Rotate the op rod upward and slide it out from the left side of the bolt carrier.

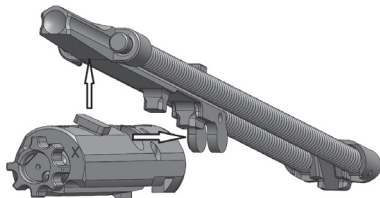

11. Pull the firing pin retaining pin out to detent.

12. Pull the firing pin and spring from the rear of the bolt carrier. Do not remove the firing pin spring from the firing pin unless replacement is required.

13. Pull the cam pin from the bolt and remove the bolt from the front of the carrier.

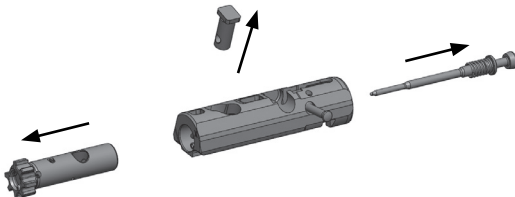

14. Push the extractor pin out and remove the extractor from the bolt. Do not remove the extractor O-Ring, extractor spring, or the extractor insert unless replacement is necessary.

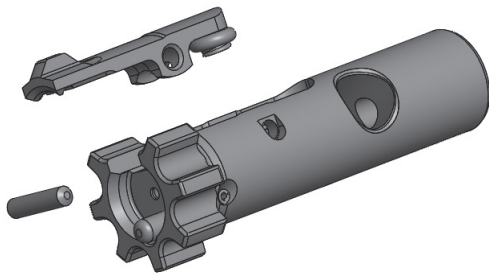

No further disassembly is authorized.

4.1.2 Gas Valve and Piston Removal

1. Depress the stop pin.
2. Rotate the gas valve until the flange on the valve is fully exposed allowing the valve to be pulled forward out of the gas block.
3. Pull the gas valve and the piston out from the front of the gas block.

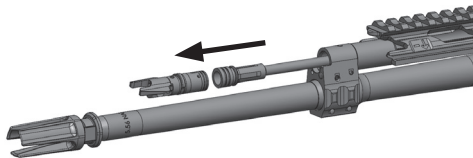
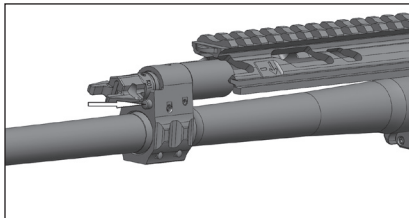

4.1.3 Handguard Removal/Installation

The handguard is held on via the pivot pin passing through the handguard link as shown here. Pull the pivot pin out to detent then pull the handguard forward off of the upper receiver.

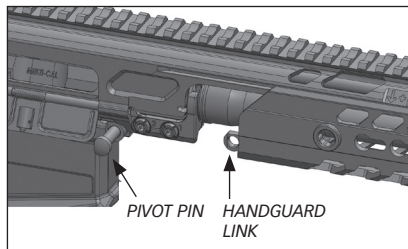

4.1.4 Barrel Removal/Re-assembly

Note: The carriage assembly must be removed prior to attempting barrel removal. The barrel clamping screws are captive to the upper receiver and only require loosening for barrel removal.

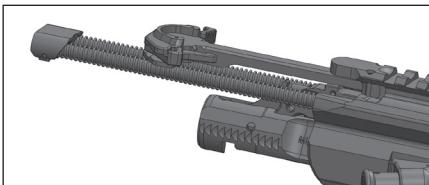

1. Using a T27 Torx wrench loosen the two barrel clamping screws from the right side of the upper receiver. These screws are captive and cannot be removed at this level of maintenance.

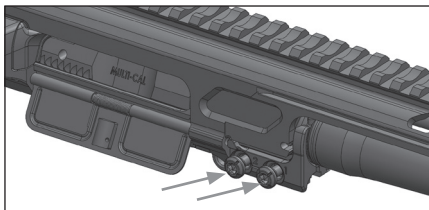

2. The left and right barrel clamps should be clear of the barrel extension flange.

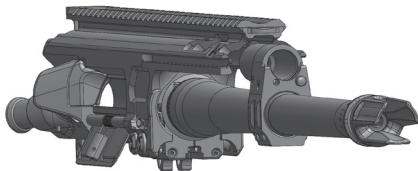

3. Pull the barrel straight out of the upper receiver. Do not wiggle it back and forth as this can damage the upper receiver. If the barrel will not pull free, use a 1" wooden dowel inserted in through the rear of the upper receiver and tap out the barrel.

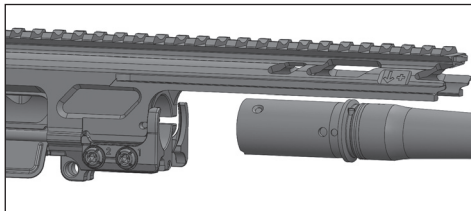

4.1.5 Barrel Installation

1. Ensure all mating surfaces are clean.
2. Check the barrel index pins for damage/looseness.
3. Slide the barrel assembly back into the upper receiver making sure the index pins are engaged properly into the upper receiver.
4. Start tightening screw #1 with the #27 Torx wrench. Alternating back and forth from screw #1 to screw #2 applying even amounts of pressure until the barrel clamps are snug.
5. Tighten screw #1, to 60 inch pounds with a torque wrench. Then tighten screw #2 to 60 inch pounds. Final step is to re-tighten screw #1 to 60 inch pounds.
6. Re-insert the bolt carrier assembly and ensure the bolt locks up properly.

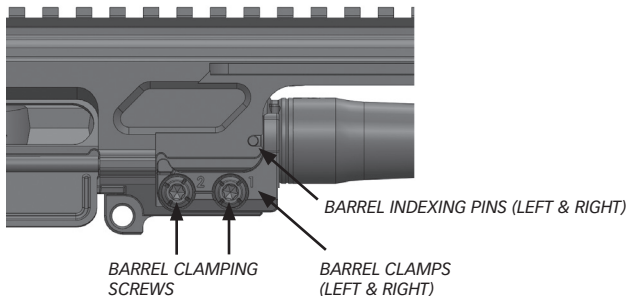

5.1 Cleaning and Lubrication

- USE ONLY CLEANING AND LUBRICATION PRODUCTS SPECIFICALLY DESIGNED FOR USE ON FIREARMS.
- DO NOT USE WIRE BRUSHES ON ALUMINUM SURFACES SUCH AS THE UPPER/LOWER RECEIVERS AS THIS CAN SCRATCH THE FINISH.
- FOLLOW ALL MANUFACTURERS INSTRUCTIONS AND CAUTIONS WHEN USING CLEANING AND LUBRICATION PRODUCTS.
- WHEREVER THE TERM CLP (CLEANER-LUBRICANT-PROTECTANT) OR THE WORDS LUBE OR LUBRICANT ARE USED IN THIS MANUAL IT IS INTERPRETED TO MEAN THAT CLP, LSA, OR LAW CAN BE UTILIZED AS APPLICABLE.

5.1.2 Cleaning the Bore and Chamber

Military sectional cleaning rods if used improperly can be damaged and cause damage to the barrel of the SIG MCX. The following steps should be adhered to which will ensure extended use of the cleaning rod assembly. Attempting to push the cleaning rod assembly through the bore from the chamber end could result in the cleaning rod being bent and the metal jag end damaging the chamber and bore. **Do not run patches through the bore with the suppressor attached.**

1. Assemble the rod sections and the jag end to the proper length.
2. Attach a clean patch to the jag.
3. Drop the drop rod female end first through the bore from the chamber end.
4. Attach the cleaning rod handle to the female rod end.
5. Apply a coat of CLP or rifle bore cleaner to the patch and slowly pull it through the bore toward the muzzle end.
6. Allow the CLP to sit in the barrel to loosen any fouling.
7. Clean all residue from the bolt, bolt carrier, and firing pin with CLP.
8. Clean the op rod, spring rods, recoil springs, and spring plate with CLP.
9. Attach a new clean patch to the cleaning rod.
10. Coat the patch as before and pull through the bore from the chamber end as you did with the first patch.

11. Remove the cleaning rod handle and attach the bore brush to the cleaning rod end.
12. Pull the brush through the bore several times to loosen any remaining residue.
13. Pull another patch through the bore with CLP or bore cleaner to remove any heavy residue loosened by the bore brush.
14. Pull new patches through the bore until they come out clean. You should not have to attach the cleaning rod handle to do this.
15. Attach the chamber brush to the rod handle end. Slide a rod section through the hold in the handle to form a T-Handle.
16. Coat the chamber brush with CLP or bore cleaner.
17. Keep the muzzle elevated so the solvent does not run into your freshly cleaned bore.
18. Make several plunging strokes followed by several 360 degree rotations in the barrel extension to clean the locking lug area.

5.1.3 Cleaning the Carriage Assembly

Under normal operating conditions the MCX bolt does not require as much cleaning as an M4 bolt. However, when used with a suppressor attached the back pressure will produce more residue which will require attention.

- a. Clean bolt body with solvent.
- b. Clean any carbon from bolt lugs.
- c. Clean hook of extractor.
- d. Clean recoil spring rods.
- e. Clean recoil springs.
- f. Clean the op rod paying attention to residue build up on the dogleg that engages the bolt carrier.
- g. Clean the cam pin of carbon build up.
- h. Clean the op rod interface of the bolt carrier.
- i. Clean the firing pin spring.
- j. Wipe down the firing pin and clean carbon build up from under the large flange of the firing pin.
- k. Wipe down the bolt carrier body.
- l. Clean the bolt channel of any carbon build up.

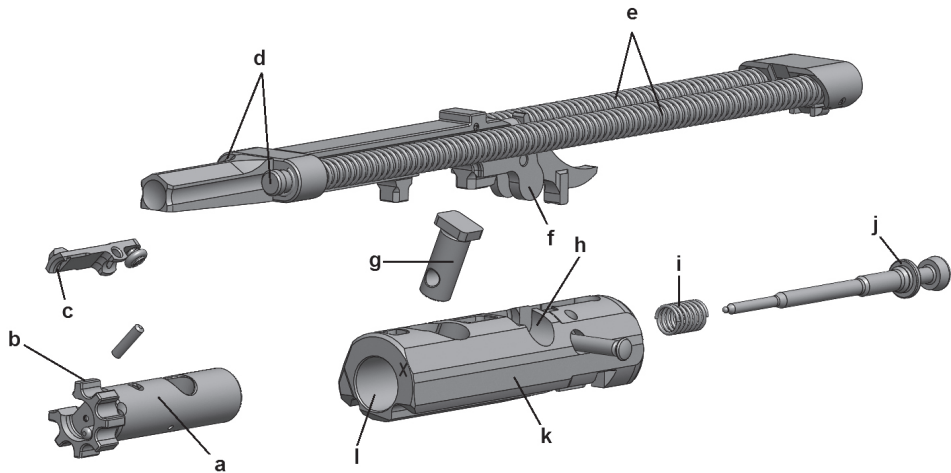

5.2 Lubrication

Carriage Assembly

- Op Rod.
- Spring guide.
- Back of bolt lugs, bolt body.
- Bolt carrier contact surfaces.
- Cam pin.
- Recoil spring rods.
- Recoil springs.

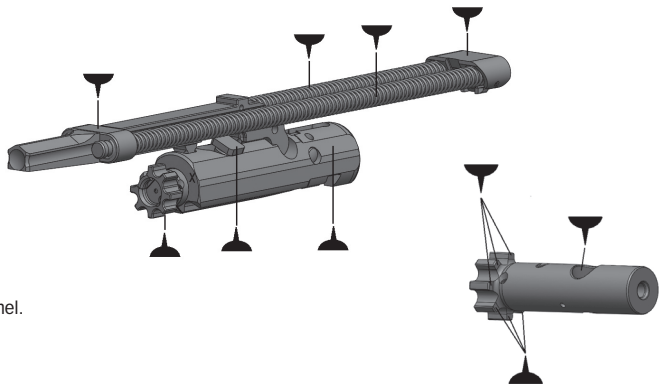

Upper Receiver

- Lubricate the upper receiver channel.

Charging Handle

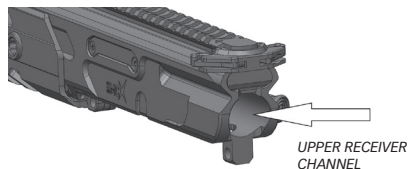
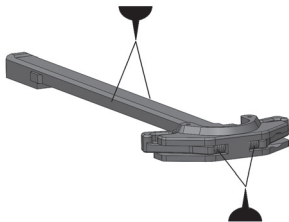

Sights

- Fold down front and rear and lubricate detent with a few drops of CLP.
- Front sight- Let a few drops seep under front sight post base and detent to keep it from freezing up.
- Rear sight-windage screw threads.

Lower Receiver Group

- Fire control selector.
- Pivot & takedown pin detent channels.
- Lightly lubricate all internal moving parts with CLP.
- Fire control components

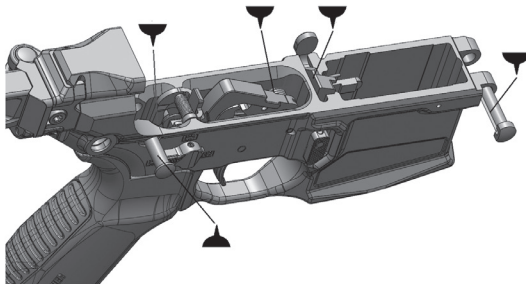

5.3 Reassembly

1. Assemble the extractor assembly to the bolt body.

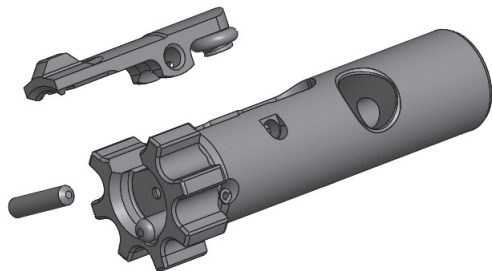

2. Insert the bolt into the front of the bolt carrier with the extractor oriented to the right side.

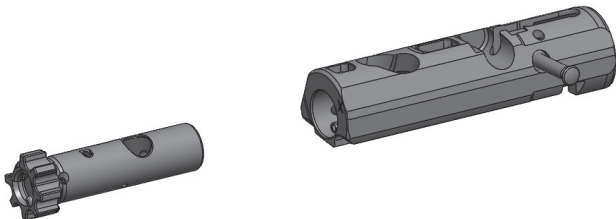

3. Insert the cam pin and align the firing pin through hole.

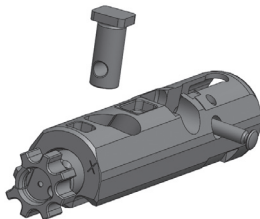

4. Slide the firing pin with the firing pin spring attached, into the rear of the bolt until it stops.

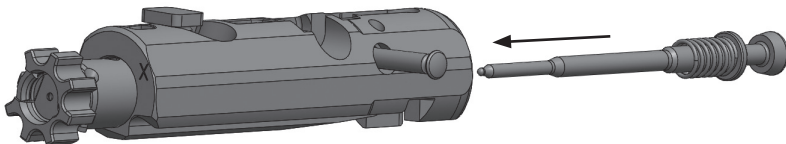

5. Push in on the firing pin until it stops. Push the firing pin retaining pin back into the bolt carrier. The firing pin retaining pin must be positioned between the large flange of the firing pin and the firing pin head. Failure to properly install the firing pin can lead to damage to the MCX and injury to the user.

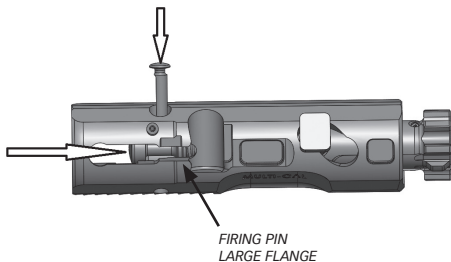

6. Assemble the firing pin lock to the op rod.

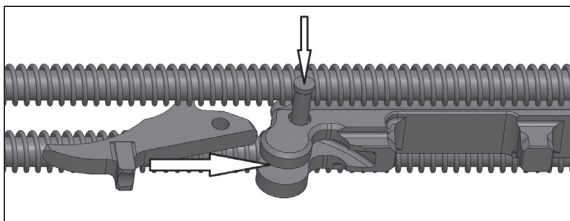

7. Lift up on the firing pin lock and slide the op rod assembly into the carrier from the left side.

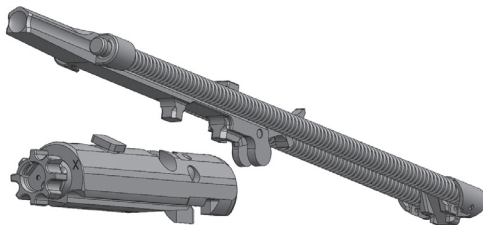

8. Install the piston in through the gas block.

9. Install the gas valve, push in on the stop pin and rotate it until it locks into the gas block.

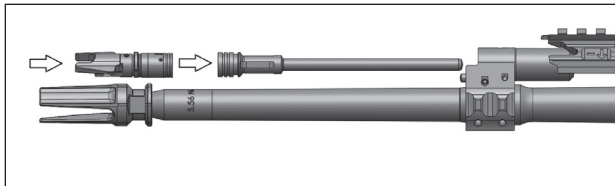

10. Attach the upper receiver to the lower receiver using the pivot pin. Make sure the handguard is slid completely rearward and that the pivot pin passes through the handguard link.

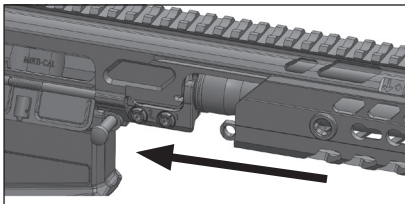

12. Insert the carriage assembly into the upper receiver.

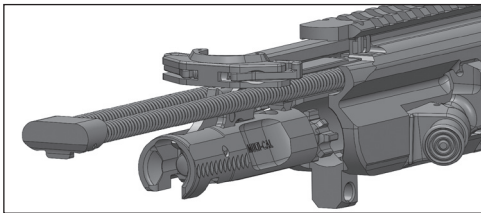

13. Close the receivers together and push the takedown pin back in place.

5.4 Function Check

1. Ensure the weapon is clear.
2. Insert an unloaded magazine into mag well.
3. Fully retract the charging handle until bolt locks to the rear, then press the charging handle forward to lock.
4. Rotate the fire control selector to SAFE.
5. Depress the magazine catch. Mag should fall free of mag well.
6. Depress bolt catch. Bolt should go forward.
7. Press trigger to rear. Hammer should not fall.
8. Rotate the selector to SEMI.
9. Press trigger and hold to rear. Hammer should fall.
10. Fully retract charging handle cocking the weapon.
11. Slowly release the trigger. You should hear an audible click.
12. Rotate the selector to AUTO (if applicable).
13. Pull the charging handle to the rear and release it.
13. Press the trigger and hold to the rear. You should hear a loud click as the hammer falls.
14. With the trigger still pressed to the rear, pull the charging handle to the rear and ease it fully forward. A loud click should be heard at the end of the travel.
15. Release the trigger.
16. No click should be heard a hammer should have followed the bolt carrier forward.
17. Press the trigger. No click should be heard.

5.5 Troubleshooting

STOPPAGE	TEST/INSPECTION	CORRECTIVE ACTION
Fails to Fire	Selector on SAFE	Rotate to a fire position
	Improper installation of firing pin	Assemble correctly
	Excessive oil in firing pin recess of bolt	Clean out with pipe cleaner
	Defective ammo	Remove / Discard
Bolt Fails to Unlock	Dirty bolt	Clean and replace
	Burred Bolt Lugs	
Failure to Feed	Dirty/Corroded ammo	Clean and replace
	Dirty magazine	Clean and replace
	Defective magazine	Replace
	Overloaded magazine	Remove excess rounds
	Magazine not seated	Check mag catch adjustment
	Under function	Contact Customer Service
Double Feed	Defective magazine	Replace
Fails to Chamber	Dirty/Corroded ammo	Clean/Replace
	Damaged ammo	Discard/Replace
	Dirty chamber	Clean

STOPPAGE	TEST/INSPECTION	CORRECTIVE ACTION
Bolt Fails to Lock	Dirty bolt lugs	Clean lugs
Fails to Extract	Frozen extractor	Remove/Clean
	Broken extractor spring	Contact Customer Service
	Restricted movement of bolt carrier group	Remove, clean, lube
	Dirty/Corroded ammo	Remove/Clean
	Dirty chamber	Clean
Fails to Lock Bolt to Rear after Last Round	Faulty magazine	Replace
	Broken bolt catch	Contact Customer Service
	*If failure to lock to the rear in condition P2 with subsonic ammo	Inspect gas system components.
Frozen Selector Lever	Needs oil	Lubricate
	Dirt/Residue under trigger.	Clean

5.6 Upper Receiver Assembly Parts Diagram

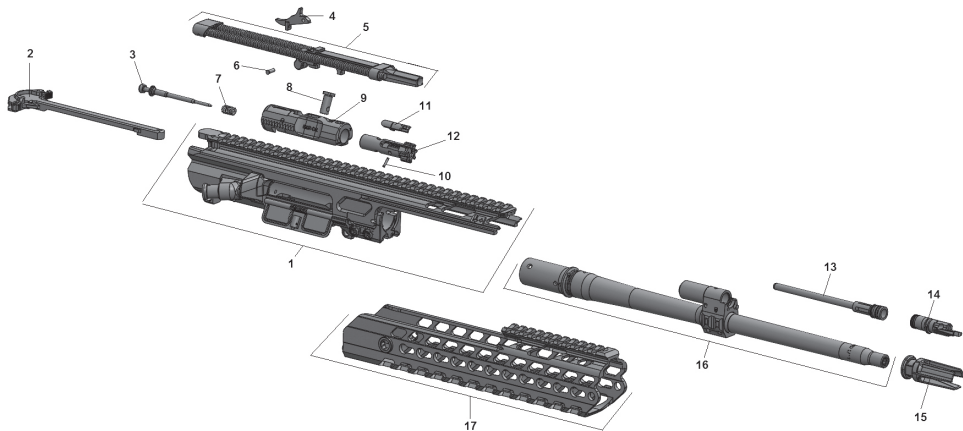

5.7 Upper Receiver Assembly Parts List

- 1 Upper Receiver Assembly
- 2 Ambi Charging Handle
- 3 Firing Pin
- 4 Firing Pin Lock
- 5 Op Rod/Recoil Spring Assembly
- 6 Firing Pin Lock Pivot Pin
- 7 Firing Pin Spring
- 8 Cam Pin
- 9 Bolt Carrier
- 10 Extractor Pin
- 11 Extractor Assembly
- 12 Bolt
- 13 Piston
- 14 Gas Valve
- 15 Flash Hider
- 16 Barrel/gas Block Assembly
- 17 Handguard Assembly

5.8 Lower Receiver Assembly Parts Diagram & Parts List

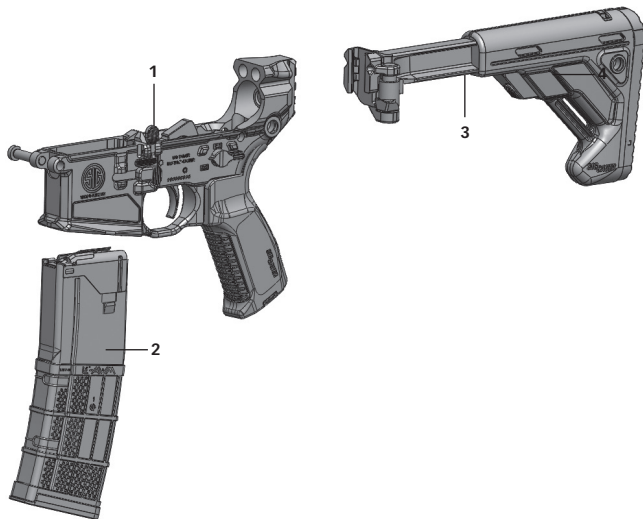

5.9 Lower Receiver Assembly Parts List

- 1 Lower Receiver Assembly
- 2 30 Round Magazine
- 3 MCX Folding/Telescoping Stock

6.0 Transportation and Storage

When transporting your firearm to and from shooting activities, keep it unloaded for your safety and for the safety of others. When storing your firearm, keep it separated from ammunition, under lock and key if possible, and out of the reach of children and other inexperienced or unauthorized persons.

WARNING – STORAGE

Never place or store any firearm in such a manner that it may be dislodged. Firearms should always be stored securely and unloaded, away from children and other unauthorized users. The use of a locking device or safety lock is only one aspect of responsible firearms storage. For increased safety, firearms should be stored unloaded and locked in a location that is both separate from their ammunition and inaccessible to children and any other unauthorized person.

STORE SECURELY & UNLOADED

Short Term Storage (90 days or less)

1. Ensure the chamber and magazine do not contain live ammunition.
2. Clean the bore and chamber.
3. Apply a medium coat of CLP to the chamber and bore.
4. Apply a light coat of CLP to all other metal surfaces for corrosion protection.
5. Do not attempt to store an MCX with a warm or hot silencer.
6. Adjust the buttstock to its shortest length to reduce the chances of damage.

Long Term Storage (90 days or longer).

1. Ensure the MCX is thoroughly cleaned.
2. Apply a medium coat of CLP to the chamber and bore.
3. Adjust the buttstock to its shortest length to reduce the chances of damage.
4. Apply a light coat of CLP to all other metal surfaces for corrosion protection.
5. Wrap the MCX with a waterproof material (MIL-B-121 or similar).
5. Place the MCX in a corrosion resistant barrier bag (MIL-DTL-117 or similar).