



WARNING!

Please read this owner's manual before taking your new DIAMONDBACK FIREARMS product out of the box. It is vital to your safety and the safety of others that you understand and adhere to the information contained in this manual, as well as information supplied by the manufacturer of the ammunition. If you have any questions, please call or write to:

DIAMONDBACK FIREARMS, LLC
3400 Grissom Pkwy. Cocoa, FL 32926
877.997.6774

DIAMONDBACK

FIREARMS



DBX

Safety and Handling Instructions

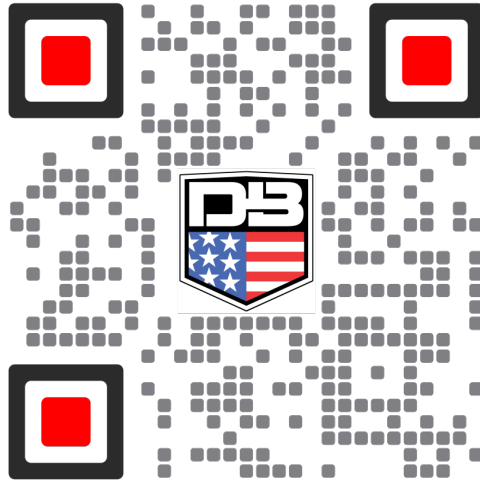

**SCAN ME FOR DBX
INSTRUCTIONAL VIDEOS**

CONTENTS

INTRODUCTION	2
SAFETY INFORMATION	3
EXPLODED VIEW	7
PARTS LIST	8
GENERAL HANDLING CAUTIONS	9
FUNCTION CHECK	10
LOADING THE MAGAZINE	11
LOADING THE FIREARM	12
FIRING YOUR DBX	16
ADJUSTING THE GAS SYSTEM	20
MAINTENANCE	22
SERVICE	38
WARNING	39
WARRANTY	40

INTRODUCTION

CONGRATULATIONS!

You are now the owner of a DIAMONDBACK FIREARMS DBX. With proper maintenance and care, it will serve you for many years to come.

To ensure the best performance from your firearm, please read and follow the instructions in this manual. Firearms are inherently dangerous and great emphasis should be placed on the need for safety. Always remember that you, as the owner, are the ultimate safety device.

You should become familiar with your firearm and its operation before using any live ammunition or actually firing. Study the instructions carefully and make sure you understand the firearm's operational guidelines.

This manual provides the necessary information you need to know in order to use your firearm safely and effectively. Should you have any questions or comments about this firearm or its use and maintenance, or if you need more information about other DIAMONDBACK FIREARMS products and accessories, please write or call:

DIAMONDBACK FIREARMS, LLC
Customer Service Dept.
3400 Grissom Pkwy.
Cocoa, FL 32926
877.997.6774

California Proposition 65 Warning

"Discharging firearms in poorly ventilated areas, cleaning firearms, or handling ammunition may result in exposure to lead and other substances known to cause birth defects, reproductive harm, and other serious physical injury. Have adequate ventilation at all times. Wash hands thoroughly after exposure."

SAFETY INFORMATION

Before you remove your new DIAMONDBACK FIREARMS product from the box, please read the following information. It is vital to both your safety and the safety of others.

Firearm safety is your responsibility.

This **SAFETY & HANDLING INSTRUCTIONS** manual should always accompany this firearm, and should be transferred with the firearm upon change of ownership or when the firearm is presented to another person.

WARNING: YOU MUST FOLLOW ALL OF THESE SAFETY RULES TO ENSURE THE SAFE USE OF YOUR FIREARM. FAILURE TO FOLLOW THE INSTRUCTIONS AND WARNINGS CONTAINED IN THIS MANUAL COULD CAUSE SERIOUS INJURY OR DEATH TO YOU OR OTHERS. DAMAGE TO PROPERTY MAY ALSO OCCUR.

ALWAYS KEEP YOUR FIREARM POINTED IN A SAFE DIRECTION. Never point a firearm at anyone or anything you do not intend to shoot, whether or not the firearm is loaded. This is particularly important when loading, unloading, or field-stripping the gun. ALWAYS control the direction of the firearm.

This firearm may be classified as a dangerous weapon and is surrendered by DIAMONDBACK FIREARMS, LLC with the understanding that the purchaser assumes all liability resulting from unsafe handling or any action that constitutes a violation of any applicable laws or regulations. Firearms can cause serious injury or death. Safety must be the prime consideration of anyone who handles firearms. Always treat a firearm as though it were loaded. Always keep the muzzle pointed in a safe direction.

When assuming ownership of a firearm, you become responsible for the safety and security of the firearm. Always secure firearms and keep out of the reach of children.

Children are attracted to and can operate firearms that can cause severe injuries or death. Prevent child access by keeping guns locked away and unloaded when not in use. If you keep a loaded firearm where a child obtains and improperly uses it, you may be fined or sent to prison.

ALWAYS TREAT EVERY FIREARM AS IF IT WERE LOADED AND WILL FIRE. Do not take anyone's word that the firearm is unloaded: always check for yourself. Never pass your firearm to another person until the cylinder or action is open and you confirm visually that it is unloaded. Keep your firearm unloaded and safely stored when not in use.

NEVER PLACE YOUR FINGER INSIDE THE TRIGGER GUARD OR ON THE TRIGGER UNLESS YOU INTEND TO FIRE.

ALWAYS BE SURE OF YOUR TARGET AND WHAT IS BEYOND IT. Always be sure where the bullet will strike, and shoot only where there is a safe backstop free of obstructions. Water or other surfaces can cause ricochets. Be sure your bullet will stop behind your target. Bullets can ricochet off many surfaces, such as rocks, and travel in unpredictable directions with considerable velocity. Do not fire randomly into the sky.

Make sure your "audience" maintains a five foot distance behind you. No one should stand next to you when you are firing a firearm.

GUN SAFETY IS YOUR RESPONSIBILITY

SAFETY INFORMATION



DIAMONDBACK
FIREARMS, LLC

- **Never touch the trigger when working the action.**
- **Never alter any components of your firearm.**
- **Never keep a loaded firearm in your home, car, boat, or RV.**
- **Never store a firearm with a cartridge in the chamber.**
- **Never store firearms and ammunition together. Keep them secured and away from children.**

For maximum safety when carrying any firearm with a loaded magazine in place, the chamber should be empty, and the action should be closed. Any gun may fire if dropped or struck.

Only use clean, dry, high-quality commercially-manufactured ammunition, that is in excellent condition which is appropriate for your firearm.

The use of reloaded and non-industry specification (SAAMI and/or CIP) ammunition will void this firearm's warranty. Reloads or poor quality ammunition may not meet industry specifications, may exceed pressure limits, and may be unsafe.

Never use ammunition where the pressure levels exceed industry standards. DIAMONDBACK FIREARMS, LLC will not be held liable for any personal injury or property damage and consequential damages, if faulty ammunition is used in DIAMONDBACK FIREARMS products.

Never take medications, drugs, or alcohol when handling firearms.

Never discharge a firearm without proper equipment. Always wear shooting glasses and hearing protection.

If the gun does not discharge after the trigger is pulled, do not change its direction for at least 30 seconds. The round could be a “hangfire”. If the gun sounds different or does not operate, unload the firearm and make sure the barrel is free from obstruction before continued firing.

Do not allow anyone to handle or attempt to fire a DIAMONDBACK FIREARM until they have read and understand this manual and the procedures for safe operation and safe gun-handling.

Be sure that all accessories are compatible with the firearm and that the accessories do not interfere with safe operation.

Never cross obstacles such as fences or streams with a loaded firearm.

Before the product left the factory, this firearm was tested, carefully inspected and packaged. DIAMONDBACK FIREARMS, LLC cannot control product handling after it leaves the factory; therefore please examine this firearm carefully at the time of purchase to ensure that it is unloaded and undamaged.

EXPLODED VIEW

DBX 5.7 PARTS LIST

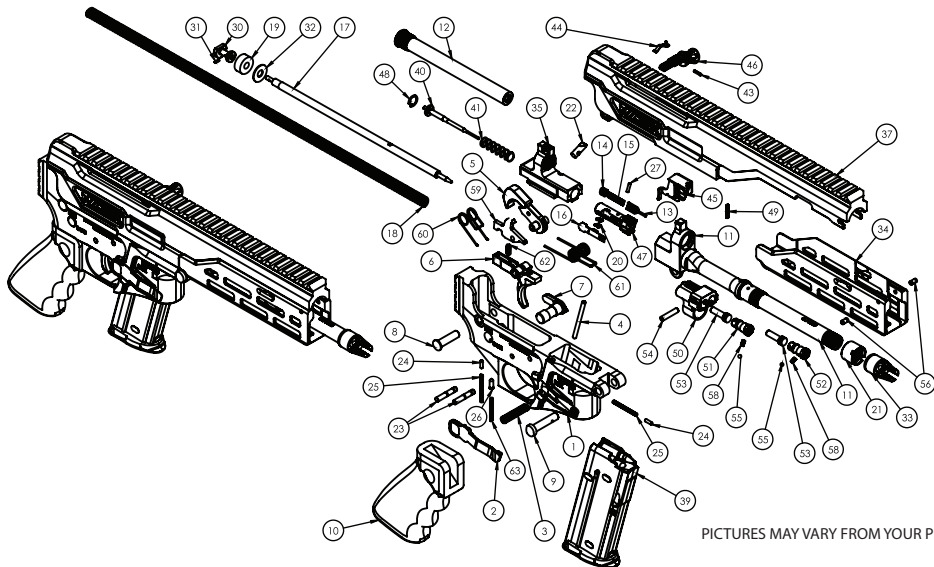

PICTURES MAY VARY FROM YOUR PRODUCT

PARTS LIST

ITEM NO.	DESCRIPTION	QTY.	ITEM NO.	DESCRIPTION	QTY.
1	LOWER RECEIVER	1	27	EXTRACTOR PIN	1
2	MAG CATCH	1	30	ACTION SPRING GUIDE ROD HEAD	1
3	MAG CATCH SPRING	1	31	GUIDE ROD HEAD PIN	1
4	MAG CATCH PIN	1	32	RECOIL BUMPER WASHER	1
5	HAMMER	1	33	FLASH HIDER	1
6	TRIGGER	1	34	HANDGUARD	1
7	SAFETY SELECTOR	1	35	CARRIER	1
8	REAR TAKEDOWN PIN	1	37	UPPER RECEIVER	1
9	FRONT PIVOT PIN	1	39	MAGAZINE	1
10	GRIP	1	40	FIRING PIN	1
11	BARREL AND TRUNNION ASSEMBLY	1	41	FIRING PIN RETURN SPRING	1
12	PISTON TUBE	1	43	CHARGING HANDLE SPRING PIN	1
13	EJECTOR	1	44	CHARGING HANDLE SPRING	1
14	EJECTOR SPRING SHROUD	1	45	BOLT CATCH	1
15	EJECTOR SPRING	2	46	CHARGING HANDLE	1
16	EXTRACTOR	1	47	BOLT	1
17	ACTION SPRING GUIDE ROD	1	48	FIRING PIN RETAINING RING	1
18	ACTION SPRING	1	49	BOLT CATCH SPRING	1
19	RECOIL BUMPER	1	50	GAS BLOCK	1
20	EXTRACTOR SPRING	4	51	PISTON CAP, SHOOTER'S RIGHT	1
21	GAS BLOCK RETENTION NUT	1	52	PISTON CAP, SHOOTER'S LEFT	1
22	CAM PIN	1	53	PISTON	2
23	HAMMER/TRIGGER PIN	2	54	PISTON CAP PIN	1
24	TAKEDOWN/PIVOT PIN DETENT	2	55	PISTON CAP DETENT	2
25	TAKEDOWN/PIVOT PIN DETENT SPRING	2	56	HANDGUARD RETENTION PIN	2
26	SAFETY SELECTOR DETENT	1	58	PISTON CAP DETENT SPRING	2
			59	DISCONNECTOR	1
			60	TRIGGER SPRING	1
			61	HAMMER SPRING	1
			62	DISCONNECTOR SPRING	1
			63	SAFETY SELECTOR DETENT SPRING	1

GENERAL HANDLING CAUTIONS

1. **DO NOT** alter or modify your firearm, and have it serviced regularly.
2. Always handle your firearm as if loaded.
3. Never point your firearm at anything you don't intend to shoot.
4. Always make sure your firearm is not loaded and the bolt is latched open and to the rear before laying it down or handing it to someone else.
5. Never leave a loaded firearm unattended.
6. Always be sure bore, muzzle, chamber and action are clear of obstruction.
7. Always check that ammunition is clean and undamaged.
8. Never drink alcoholic beverages or take drugs before or during shooting.
9. Always wear eye and ear protection while shooting.
10. Always keep the safety on "**SAFE**" when the firearm is loaded and a round is chambered until ready to shoot.
11. Never attempt to fire if water is in the bore.
12. Never engage in "horseplay" when holding your firearm.
13. Ensure that the cam pin is properly installed in the bolt group. If it isn't, your firearm can still fire, but it could possibly explode, causing you personal injury or harm.
14. **DO NOT** exchange or switch bolt assemblies from one firearm to another. It can cause personal injury to you and others and damage your firearm.
15. If your firearm fails to fire, hold it, keep it pointed towards the target and wait 30 seconds. If a hang fire has occurred, the round should fire within 30 seconds. If the round does not fire, first remove the magazine, eject the round, and examine the primer. If the firing pin indent is light, misaligned or non-existent, have your firearm examined by a qualified gunsmith. If firing pin indent on the primer appears normal in comparison to previously fired rounds, assume faulty ammunition; appropriately dispose of misfired round from other live ammunition; reload and resume firing.

FUNCTION CHECK

WALD

SAFE Note: Remove the magazine and make sure your firearm is unloaded and there is no ammunition in the chamber. Point the firearm in a safe direction. Pull the charging handle to the rear and release. Place on safe. Pull the trigger. The hammer should not fall. See (Fig. 1)

FIRE Note: Remove the magazine and make sure your firearm is unloaded and there is no ammunition in the chamber. Point the firearm in a safe direction. Place the selector on fire. Pull the trigger and hold it to the rear. The hammer should fall. Pull the charging handle to the rear and release. Release the trigger and an audible click should be heard. Pull the trigger again and the hammer should fall. See (Fig. 2)



“SAFE” The firearm will not fire. The selector lever cannot be on safe unless the firearm is cocked. Always place the firearm on “SAFE” when loading and unloading.



“FIRE” The firearm will fire one round each time the trigger is pulled.

LOADING THE MAGAZINE

1. Use only ammunition for which your firearm is chambered.
2. With front of magazine forward, place a cartridge above and parallel to the top of the magazine feed lips with its bullet facing forward. Pass the cartridge down between the magazine feed lips and onto the magazine follower; continue pressing the cartridge down until it is retained by the magazine feed lips. Place the next cartridge on top of the previous cartridge and press down until it is also retained by the magazine feed lips; repeat this process until the desired number of cartridges are loaded into the magazine.

USE OF SAFETY SELECTOR

1. **DO NOT** alter or modify your firearm, and have it serviced regularly.
2. Always handle your firearm as if loaded.
3. Never point your firearm at anything you don't intend to shoot.

LOADING THE FIREARM

To load the firearm...

1. Ensure that the safety selector is set to **“SAFE”** and that the muzzle is pointed in a safe direction.
2. Beginning with the bolt in the closed position and the magazine removed, retract the bolt fully rearward via the charging handle and then keep it held to the rear (see Fig. 3). If the hammer were not already cocked before-hand, this motion will cock the hammer.
3. Slide the bolt catch upward while gently lowering the bolt forward until it stops against the bolt catch (see Fig. 3).
4. With the bullets facing forward, insert the loaded magazine into the magazine well and push it upward until it stops and it is retained by the magazine catch (see Fig. 4).
5. Keep the firearm pointed in a safe direction and slide the bolt catch downward (see Fig. 5). This will allow the bolt to return forward, stripping a cartridge from the magazine and loading it into the chamber. The firearm is now loaded with a cartridge in the chamber and the hammer is cocked.
6. If for some reason the bolt does not return to its fully forward position, the charging handle may be used to urge the bolt fully forward and close the action.

CAUTION Always check that your ammunition is clean and undamaged before forcing the bolt closed on a cartridge in the chamber. Forcing the damaged or otherwise unsuitable ammunition into the chamber could result in personal injury or death to you and/or others and may cause damage to your firearm and/or property. The use of reloaded, hand loaded, or ammunition loaded to pressures above industry standards can be dangerous and will void the firearm's warranty.



FIG. 3



FIG. 4



FIG. 5

FIREARMS

UNLOADING THE FIREARM



To unload and/or clear the firearm...

1. Ensure that the safety selector is set to **“SAFE”** and that the muzzle is pointed in a safe direction.
2. Depress the rearward pad of the magazine catch to pivot it open and remove the magazine (see Fig. 6)
3. If the last cartridge in the magazine had been fired while the magazine was installed, the bolt should already be locked to the rear by the bolt catch. If this is the case, skip ahead to step #6. If the bolt is currently closed, then proceed to the next step.
4. Retract the bolt fully rearward using the charging handle; keep it held back. If a cartridge was present in the chamber, this motion should cause it to be extracted and then subsequently ejected from the firearm through the ejection port.

CAUTION DO NOT place your fingers or any part of your body into or near the edges of the ejection port opening even if the bolt is being held open by the bolt catch mechanism or by any other means. The action spring imparts a significant force load onto the bolt carrier urging it forward to the closed position. Any item, including fingers or body parts can easily become pinched, smashed, broken, or otherwise injured if the bolt were to inadvertently close on it.

5. Slide the bolt catch upward while gently lowering the bolt forward until it stops against the bolt catch.
6. Check to ensure there are no ammunition cartridges in the receiver nor in the chamber.
7. Ensuring once again that the safety selector is set to **"SAFE"** and that the firearm is pointed in a safe direction, slide the bolt catch downward (See Fig. 7). This will allow the bolt to return forward.



FIRING YOUR DBX

The DBX is a semi-automatic, auto-loading firearm; continue to keep the muzzle pointed in a safe direction before, during, and after firing a shot.

Keep your finger off the trigger and DO NOT disengage the safety until the muzzle of the firearm is pointed in a safe direction and you are ready to fire.

To Fire...

1. Always wear hearing and eye protection when you are firing or observing someone else firing your DBX.
2. Load firearm per the procedure previously described in this manual.
3. Grasp the firearm in whichever manner you find most comfortable and allows you to best maintain control over the firearm. It is also important to consider that you will need easy and convenient access to all necessary controls while keeping yourself and your clothing and/or accessories clear of the path of the reciprocating charging handle.

CAUTION The charging handle of the DBX is designed to reciprocate back and forth with every firing cycle and it does so with tremendous speed and force. Keep your body parts and your clothing and/or accessories clear of the path that the charging handle will traverse, otherwise personal injury or property damage may occur.

4. Align your sights or optic with the intended target.
5. Move the safety selector to the **"FIRE"** position.
6. Keep steady aim, place your trigger finger on the trigger and squeeze gently until the trigger releases the hammer and the shot is fired. Upon firing a shot, the firearm will extract and eject the spent cartridge casing and load the next cartridge from the magazine into the chamber; the hammer will have been automatically re-cocked and the safety selector will remain in the **"FIRE"** position leaving the firearm ready to fire once again.
7. If you have not already done so, release the trigger and allow the hammer to automatically "reset" from the disconnecter to the trigger; you will hear and feel the fire control mechanism "click".
8. To fire the next round and each subsequent round repeat steps #6 through #8 until either the magazine is empty or you no longer wish to fire another shot.
9. Remove your finger from the trigger and set the safety selector to **"SAFE"**.
10. Follow the procedure that was previously outlined in this manual to unload and/or clear the firearm.



CHANGING SIDES FOR CHARGING HANDLE

1. Ensure that the firearm is unloaded and clear of any ammunition using the procedure described previously in this manual.
2. Begin with the bolt in the closed position.
3. Firmly grasp the charging handle and remove it from the upper receiver by pulling it out in a direction perpendicular to the flat side of the upper receiver. (See Fig. 10)

To install the charging handle:

1. Ensure that the firearm is unloaded and clear of any ammunition using the procedure described previously in this manual.
2. Begin with the bolt in the closed position.
3. Orient the charging handle assembly so that the charging handle spring faces upward toward the top of the upper receiver.
 - Insert the open end of the rectangular shaft of the charging handle assembly into the corresponding rectangular hole in top of the carrier; this rectangular hole is visible through the charging handle slot in the upper receiver (See Fig. 11).
 - Firm resistance from the charging handle spring will be encountered as the charging handle assembly is inserted.
4. Continue inserting the charging handle assembly with enough



force to overcome the detent action of the charging handle spring. Insertion force should be applied in a direction perpendicular to the flat side of the upper receiver until the charging handle assembly has been fully installed and the shoulder on the rectangular shaft of the charging handle is resting against the outer face of the carrier. (See Fig. 12)



ADJUSTING THE DBX GAS SYSTEM

The dual-piston gas system of the DBX is designed to be easily adjustable at the user level. This feature allows the firearm to be tuned for optimal performance with your chosen type of ammunition or in the event of firing with a suppressor/silencer installed. The gas system is factory-adjusted so that it works well for the ammunition used during our test firing. If the firearm is not functioning well with your chosen type of ammunition, you may need to adjust the gas system to allow for either more or less gas flow into the piston chambers, depending upon the types of malfunctions or performance issues you are experiencing.

If you feel that the recoil impulse is overly harsh or you feel the trigger blade rebounding into your finger uncomfortably during the firing cycle, then you should adjust your gas system to a lower setting. Changing the gas system to a lower setting will allow gas into the piston chambers at a slower rate thus reducing the rearward velocity of the bolt carrier during the firing cycle.

If your firearm does not reliably cycle fully to the rear upon firing or you are having failures to feed, failures to eject, weak ejection, or the firearm is ejecting spent cartridge cases noticeably forward instead of out to the side, then you should adjust your gas system to a higher setting. Adjusting the gas system to a higher setting will allow gas into the piston chambers at a faster rate thus increasing the rearward velocity of the bolt carrier during the firing cycle.

To Adjust the Gas System

1. Ensure that the firearm is unloaded and clear of any ammunition using the procedure described previously in this manual.
2. Although gas system adjustments can be made with the firearm fully assembled by accessing the gas block from the muzzle end with an extended reach, flat-head screwdriver, as an added safety precaution it is strongly recommended that you field strip the firearm down to the barrel and gas block assembly per the procedure

described in this manual. This approach will also make it easier to access and view the parts during the process of adjusting the gas system.

3. The gas settings are visible through sight windows in the handguard on both the shooter's left-hand and the shooter's right-hand side of the firearm (See Fig. 13).

4. The active setting for each piston cap is indicated by the hash mark and number on the piston cap which is aligned with the pointer indicator on the gas block (See Fig. 13). Proper angular alignment of each piston cap is controlled by a spring-loaded detent which will provide both tactile and audible feedback as the piston cap is rotated from one setting to another.

5. To change the setting of each piston cap, use a flat-head screwdriver, coin, or other suitably sized object to rotate the piston cap until the desired active setting's hash mark and number are aligned with the pointer indicator on the gas block (See Fig. 13) and the detent "click" is felt and/or heard to indicate that the alignment is correct for that setting. The piston caps are pinned in place and not threaded which allows them to be rotated both clockwise or counter-clockwise using the same process; this also means they can be rotated as many revolutions in either direction necessary without fear of them backing out or over-tightening.

6. Since each piston cap must be adjusted independently, to ensure proper function as intended, you must ensure that the active setting for both piston caps matches. This means that the hash mark and number on each piston cap that is aligned with the pointer indicator on the gas block must be the same on both the shooter's left-hand and the shooter's right-hand side of the firearm. Firing your DBX with the gas system improperly adjusted may cause excessive and uneven wear to various components and will void the manufacturer's warranty on your firearm.

7. Once the desired setting is achieved, reassemble the firearm per the procedure described in this manual.



MAINTENANCE/FIELD STRIPPING

WARNING: ALWAYS WEAR SAFETY GLASSES WHEN DISASSEMBLING OR REASSEMBLING A FIREARM.

NOTE: By design, there is intentional interference and an associated preload between the upper receiver, handguard, and lower receiver. This preload may make the takedown pin and pivot pin somewhat difficult to remove by hand, so it may be helpful to have punch and small hammer available for this process.

1. Ensure that the firearm is unloaded and clear of any ammunition using the procedure described previously in this manual.
2. Begin with the bolt in the closed position.
3. Apply opposing forces from the top of the upper receiver and the bottom of the lower receiver to compress the rear portion of the joint between the upper and lower receiver to relieve the preload from the takedown pin. Press the takedown pin (rear pin) from the shooter's left side of the lower receiver and pull it out the right side until it comes to a positive stop. It may be necessary to use a punch if the fit of the pin is still tight. The takedown pin uses a spring-loaded detent to retain this pin in the installed/closed position; this detent will also prevent the takedown pin from being fully removed from the lower receiver. Once the takedown pin is fully extracted to the open position, the applied clamping force may be released, but do not allow the rear of the upper receiver to pivot forward. (See Fig. 14)
4. Press the pivot pin (front pin) from the shooter's left side of the lower receiver and pull it out the right side until it comes to a positive stop. It may be necessary to use a punch if the fit of the pin is still tight. The pivot pin uses a spring-loaded detent to retain this pin in the installed/



closed position; this detent will also prevent the pivot pin from being fully removed from the lower receiver. (See Fig. 15)

5. Separate the lower receiver assembly from the upper receiver assembly and place the lower receiver aside. Further disassembly of the lower receiver assembly by anyone other than a qualified gunsmith or Diamond-back Firearms will void the manufacturer's warranty.

6. Slide the handguard toward the muzzle end until the two retention pins at the front of the handguard are free from their retention slots in the upper receiver. Continue sliding the handguard forward and away from the upper receiver until it has been removed and then place the handguard aside. (See Fig. 16)

7. With the upper receiver upside down, retract the bolt fully rearward via the charging handle and engage the bolt catch so that it is holding the bolt assembly fully rearward. (See Fig. 17)

8. Remove the charging handle per the procedure previously listed in this manual while being mindful not to disengage the bolt catch so that the bolt remains open.

9. Depress the action spring guide rod head by about 1/8" toward the muzzle end to unseat it from its counterbore in the upper receiver; hold it in this position to allow more freedom of movement for the components during disassembly. (See Fig. 18)



FIG. 16



FIG. 17

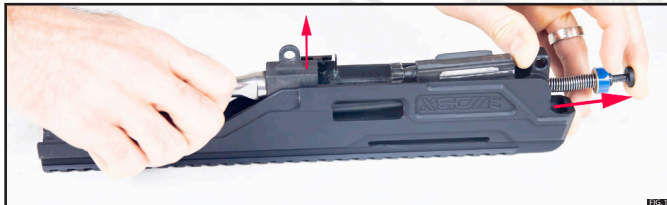

FIG. 18

MAINTENANCE/FIELD STRIPPING cont'd

CAUTION MAINTAIN FULL CONTROL OF THE ACTION SPRING GUIDE ROD ASSEMBLY AND ACTION SPRING DURING DISASSEMBLY OF THESE COMPONENTS. THE ACTION SPRING GUIDE ROD ASSEMBLY IS UNDER SIGNIFICANT SPRING LOAD AND IF NOT HANDLED CAREFULLY THESE COMPONENTS MAY BE LAUNCHED FROM THE ASSEMBLY AT A HIGH VELOCITY WHICH MAY RESULT IN PERSONAL INJURY AND/OR PROPERTY DAMAGE. KEEP BOTH ENDS OF THE UPPER RECEIVER POINTED IN A SAFE DIRECTION SO THAT YOU, NOR ANY BYSTANDERS, NOR ANY FRAGILE OR EXPENSIVE PROPERTY ARE IN THE LIKELY PATH OF TRAVEL IN THE EVENT OF PARTS BEING THROWN FROM THE ASSEMBLY.

10. Firmly grasp the barrel and while keeping the axis of the barrel mostly parallel to its installed state (meaning don't pry it up at a steep angle or it will bind and may cause damage to components), begin to lift and wiggle the barrel assembly, bolt carrier assembly, and action spring guide rod slightly upward but not fully out of the upper receiver. As the components are beginning to lift out, you must be mindful to maintain control of the action spring guide rod as it is under significant spring load. Once the components are lifted out of the upper receiver far enough so that the action spring guide rod assembly will clear its retaining wall in the upper receiver, carefully remove the action spring guide rod assembly and action spring through the hole in the rear of the upper receiver (see Fig. 19) and place the action spring guide rod assembly and action spring aside.



11. Ensuring that the bolt carrier assembly remains fully rearward, lift the barrel assembly and bolt carrier assembly fully out of the upper receiver (see Fig. 20). While lifting out the barrel assembly, you must also maintain control of the bolt catch which rides on the trunnion and will come out with this assembly; also be mindful not to lose the bolt catch spring which sits in a pocket in the upper receiver behind the bolt catch (see Fig. 20). Separate the bolt carrier assembly from the barrel assembly and place all components aside. Further disassembly of the barrel assembly (aside from the removal of the muzzle device) or bolt carrier assembly by anyone other than a qualified gunsmith or Diamondback Firearms will void the manufacturer's warranty.

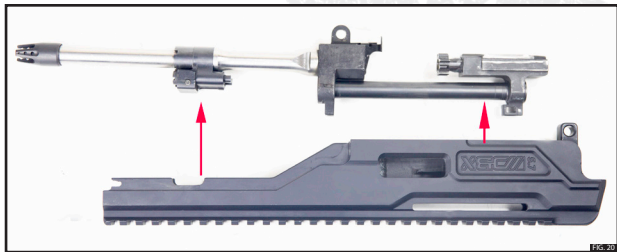

MAINTENANCE/CLEANING PROCEDURE

The recommended procedure for cleaning the DBX is explained below. To begin this process, you must first field strip the firearm per the procedure detailed previously in this manual. Do not disassemble the DBX any further than described unless done so by a qualified gunsmith or the manufacturer's warranty will be voided. Once cleaned and dried, follow the lubrication instructions noted in this manual prior to reassembly.

- o **Barrel Assembly** – Using your preferred gun cleaning solvent, clean all areas that appear fouled, corroded, or dirty including the barrel bore and chamber, trunnion lug ways for the bolt, gas block exterior, exposed portions of the pistons. Once cleaning is complete, dry the parts of any remaining solvent and do not reassemble anything until the proper lubrication has been applied per the procedure detailed in this manual.
- o **Bolt Carrier Assembly** – Using your preferred gun cleaning solvent, clean the exposed portion of the bolt (including breech face, firing pin hole, lugs, and neck area behind bolt head), extractor claw, and ejector tip. Any other areas on the bolt carrier assembly that appear fouled, corroded, or dirty should also be cleaned, including the cam pin, cam path, exterior surfaces of the carrier, and the accessible surfaces of the piston tube. Once cleaning is complete, dry the parts of any remaining solvent and do not reassemble anything until the proper lubrication has been applied per the procedure detailed in this manual.
- o **Action Spring Assembly** – Using your preferred gun cleaning solvent, clean any areas that appear fouled, corroded, or dirty. Note that the head of the action spring guide rod is aluminum, so cleaning this component with a wire brush or any type of abrasive material should be avoided. Once cleaning is complete, dry the parts of any remaining solvent and do not reassemble anything until the proper lubrication has been applied per the procedure detailed in this manual.

- o **Upper Receiver** - Using your preferred gun cleaning solvent, clean any areas that appear fouled, corroded, or dirty, paying particular attention to the bolt carrier guide shelves and the cam pin guide shelf (see Fig. 21). Note that the upper receiver is aluminum, so cleaning this component with a wire brush or any type of abrasive material should be avoided. Once cleaning is complete, dry the parts of any remaining solvent and do not reassemble anything until the proper lubrication has been applied per the procedure detailed in this manual.
- o **Handguard** - Using your preferred gun cleaning solvent, clean any areas that appear fouled, corroded, or dirty, paying particular attention to the region around the gas block. If your DBX is equipped with an aluminum handguard, cleaning this component with a wire brush or any type of abrasive material should be avoided. Once cleaning is complete, dry the parts of any remaining solvent and do not reassemble anything until the proper lubrication has been applied per the procedure detailed in this manual.
- o **Lower Receiver Assembly** - Using your preferred gun cleaning solvent, clean any areas that appear fouled, corroded, or dirty, paying particular attention to the fire control mechanism components. Note that the lower receiver is aluminum, so cleaning this component with a wire brush or any type of abrasive material should be avoided. Once cleaning is complete, dry the parts of any remaining solvent and do not reassemble anything until the proper lubrication has been applied per the procedure detailed in this manual.

With the firearm disassembled and cleaning complete, thoroughly inspect all components for cracks, chips, or any excessive wear. If any defects or out of the ordinary wear is identified, discontinue use of the firearm and contact Diamondback Firearms for further assistance.



MAINTENANCE/LUBRICATION

Barrel Assembly:

- o Lightly lube the barrel bore and chamber along with the accessible surfaces of the barrel, trunnion, gas block, and exposed portions of the pistons.
- o Lightly lube all surfaces of the bolt catch component.
- o Generously lube the cylindrical faces of the three short bosses on the trunnion; this will provide lubrication for smooth movement of the bolt catch mechanism. (See Fig. 22)

Bolt Carrier Assembly:

- o Lightly lube the exposed portion of the bolt (including breech face, firing pin hole, lugs, and neck area behind bolt head), extractor claw, and ejector tip. All other accessible areas on the bolt carrier and the interior surfaces of the piston tube should also be lightly lubed.
- o Generously lube the cam pin, cam path surfaces in the carrier, bolt body that is visible through cam path, and exterior surfaces of the piston tube. (See Fig. 23)

Action Spring Assembly:

- o Lightly lube the accessible surfaces of the action spring guide rod, although the anodized aluminum head does not require lubrication nor additional corrosion protection.

Upper Receiver:

- o Generously lube the bolt carrier guide shelves and the cam pin guide shelf along with about 1/8" high on the adjacent walls (see Fig. 24). All other interior and exterior surfaces of the anodized aluminum upper receiver do not require lubrication nor additional corrosion protection.

Handguard:

- o No lubrication nor additional corrosion protection is required for the handguard.

Lower Receiver Assembly:

- o Lightly lube the fire control mechanism components, takedown pin, and pivot pin. All other interior and exterior surfaces of the anodized aluminum lower receiver do not require lubrication nor additional corrosion protection.

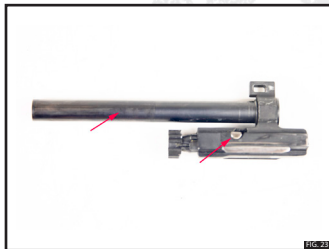
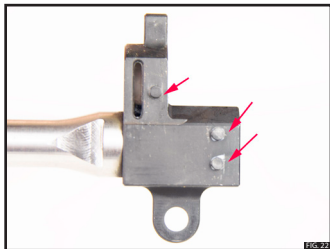

MAINTENANCE/ASSEMBLY

1. Insert the bolt catch spring into its hole in the upper receiver. (See Fig. 25)
2. Install the bolt catch onto the trunnion as shown and place it in position so that it would hold the bolt open. (See Fig. 26)
3. Insert the action spring guide rod through the action spring until one end of the spring is seated against the recoil bumper washer. (See Fig. 27)

CAUTION Maintain full control of the action spring guide rod assembly, action spring, and bolt carrier assembly during assembly of these components. The action spring guide rod assembly and bolt carrier assembly are under significant spring load and if not handled carefully components may be launched from the assembly at a high velocity which may result in personal injury and/or property damage. Keep both ends of the action spring guide rod pointed in a safe direction so that you, nor any bystanders, nor any fragile or expensive property are in the likely path of travel in the event of parts being thrown from the assembly.

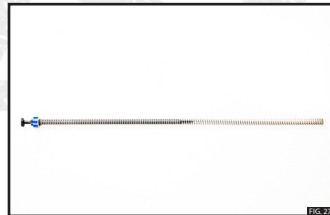
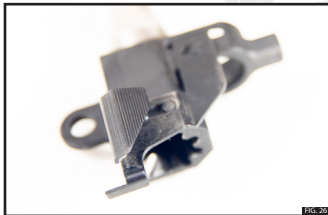

4. Insert the action spring assembly into the piston tube of the bolt carrier assembly. Fully compress the action spring until the rear flange of the piston tube sits against the recoil bumper washer and then install the included cotter pin through the hole in the action spring guide rod that is now exposed near the muzzle end of the piston tube (see Fig. 28). A punch, nail, or other small diameter cylindrical object that will fit through the hole and is strong enough to hold back the force of the action spring may be substituted for this operation if the originally included cotter pin is not readily available.
5. Lower the bolt carrier / action spring assembly down into the rear portion of the upper receiver with the flat on the guide rod head facing toward the inside of the upper receiver and the bolt carrier assembly above the piston tube. Keep the muzzle end of the action spring guide rod pointed upward at approximately 15° and rest the neck of the guide rod head in the slot of the action spring retention wall in the rear of the upper receiver. (See Fig. 29)
6. Ensure that the bolt is in its fully extended position so that the bolt lugs will be properly aligned for installation of the barrel assembly and keep the bolt carrier / action spring assembly pointed upward at a 15° angle. Using one hand, grasp the front edges of the bolt carrier behind the bolt head and hold it rearward to fully compress the action spring. Hold it in this position and remove the cotter pin from the hole in the action spring guide rod; holding the action spring compressed will require notable effort and care should be taken to control the assembly so that parts are not launched from the assembly.

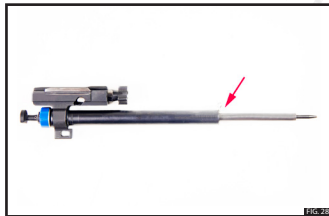

MAINTENANCE/ASSEMBLY cont'd

ABX

7. Hold the bolt catch in position on the trunnion as previously prepared and bring the barrel assembly toward the upward pointing end of the piston tube with the trunnion facing rearward. Slide the guide hole in the trunnion over the action spring guide rod and continue sliding the barrel assembly toward the bolt until the pointed tip of the action spring guide rod is inserted into its support hole in the rear end of the gas block. (See Fig. 30)

8. As the trunnion approaches the tip of the piston tube, ensure that the bolt catch remains in the “hold-open” position so that the bolt catch is pressing against the tip of the piston tube. Control of the bolt catch must be maintained throughout the next several steps to ensure that it does not fall off the trunnion and also so that it doesn’t release the piston tube and allow the bolt to close. (See Fig. 31)

CAUTION Do not place fingers or any part of your body between the bolt carrier and the chamber end of the trunnion. Also avoid placing body parts between the muzzle end of the piston tube and the gas block. The bolt carrier assembly is under significant spring load and if not handled carefully the bolt assembly may close unexpectedly which may result in personal injury and/or property damage.

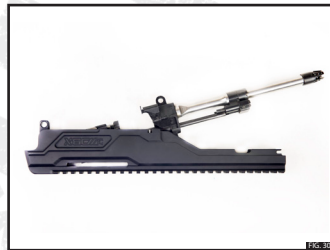

9. Grasp the barrel assembly firmly and maintain control of the bolt catch so that it doesn't fall off the trunnion. Slowly and gently compress the piston tube rearward by pressing on its tip with the bolt catch / trunnion / barrel assembly. Once the action spring load has been fully transferred to being held by the bolt catch / trunnion / barrel assembly, release your grip on the bolt carrier with the other hand and concentrate on holding the upper receiver firmly in place.
10. Hold the bolt carrier assembly rearward with the bolt catch / trunnion / barrel assembly and pivot the barrel assembly downward into the upper receiver. Align the bolt catch bridge with its clearance cut over the bolt catch spring in the upper receiver and continue pivoting the barrel assembly down until the top lug of the trunnion can be felt seating into its pocket in the upper receiver (see Fig. 32). Hold the bolt catch in its "hold-open" position during this entire step to ensure that the bolt does not close unexpectedly.
11. Firmly press the trunnion to ensure that it is fully seated, then verify that the wings on both sides of the gas block are also sitting flush against the top of their clearance notches in the upper receiver (See Fig. 33).
12. Ensure that your fingers or other body parts and tools are clear of the pinch points in the assembly then actuate the bolt catch to release the bolt and allow it to close. (See Fig. 34)

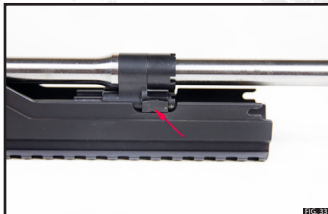
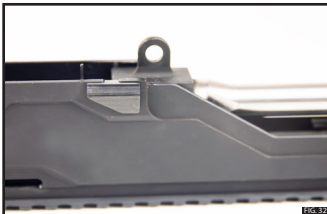

MAINTENANCE/ASSEMBLY cont'd

13. Install the handguard onto the upper receiver. Ensure that the retention features on both the shooter's left-hand and shooter's right-hand side of the top, muzzle end of the handguard are captured in their respective mating features on the upper receiver. The pivot pin holes in the handguard should be nearly aligned with the pivot pin hole on the trunnion but won't be fully aligned due to the intentional assembly clamping interference between the gas block and the handguard (see Fig. 35). The narrower section of the upper receiver must fit within the handguard, the pivot pin hole tab on the trunnion must fit between the pivot pin ears on the handguard (see Fig. 36), and the angled gas block retention features on the handguard should line up and rest against the underside of the wings on the gas block (see Fig. 37).

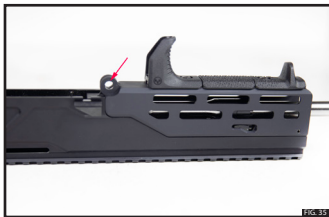

14. Install the charging handle per the procedure described in the appropriate section of this manual.

15. Position the upper receiver assembly onto the lower receiver assembly with the pivot pin ears on the handguard centered within the pivot pin slot at the upper, muzzle end of the lower receiver assembly. Squeeze the handguard tightly to the upper receiver so that the pivot pin holes on the handguard fully align with the pivot pin hole in the trunnion. Align the three pivot pin holes of the upper receiver assembly (two ears of the handguard and one through the tab on the trunnion) with the pivot pin features in the lower receiver assembly and press the pivot pin (front pin) from the shooter's right-hand side to drive it through all of the noted holes and pinning the upper receiver pivotally to the front of the lower receiver (see Fig. 38). It may be necessary to use a small hammer if the fit of the pin is still tight. Once the pivot pin is fully seated in the closed position, the squeezing force between the handguard and upper receiver may be released, but control of the upper receiver should be maintained so that it does not pivot forward.

16. Apply opposing forces from the top of the upper receiver and the bottom of the lower receiver to compress the rear portion of the joint between the upper and lower receiver to allow proper alignment of the takedown pin holes. Press the takedown pin (rear pin) from the shooter's right-hand side of the lower receiver until it is fully seated. It may be necessary to use a small hammer if the fit of the pin is still tight. Once the takedown pin is fully seated in the closed position, the applied clamping force may be released. (See Fig. 39)

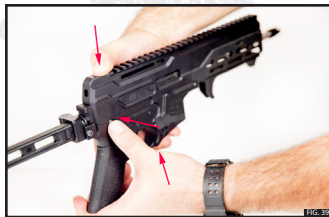

UNUSUAL CONDITIONS

EXTREME COLD

- a. Clean and lubricate the firearm with gun lubricant. Keep it moisture free.
- b. Operate controls through their entire range at intervals to keep them from freezing solid.
- c. When your firearm is not being used and kept outside, protect it with a cover.

HOT CLIMATES

- a. Clean and inspect the firearm more frequently to help prevent and protect from corrosion.
- b. When handling, make certain to wipe dry, as moisture could cause corrosion. After drying, lubricate the firearm.

DUSTY/SANDY AREAS

- a. Keep dust and sand out of components and mechanisms of the firearm.
-

PROJECTILE LODGED IN BORE

WARNING If a round is fired wherein the report is noticeably more quiet than normal or the recoil impulse is noticeably softer than normal, **CEASE FIRE IMMEDIATELY**. Keep the muzzle of the firearm pointed in a safe direction and clear the firearm per the procedure previously detailed in this manual; however, instead of closing the bolt after clearing the firearm of ammunition, the bolt should remain held in the open position by the bolt catch. Visually inspect and/or insert a cleaning rod into the bore to ensure there is not a projectile lodged in the bore. If a projectile is lodged in the barrel bore, **DO NOT** attempt to remove it; discontinue use of the firearm and contact Diamondback Firearms for further assistance.

ALWAYS PRACTICE SAFE FIREARMS HANDLING—

WARNING: IF THIS FIREARM IS CARELESSLY OR IMPROPERLY HANDLED, UNINTENTIONAL DISCHARGE COULD RESULT AND COULD CAUSE INJURY, DEATH, OR DAMAGE TO PROPERTY.

CAUTION: CAREFULLY READ THIS INSTRUCTION MANUAL PRIOR TO LOADING AND FIRING THIS FIREARM. FOLLOW ALL INSTRUCTIONS ON THE PROPER HANDLING AND SAFE USE OF THIS FIREARM - LIVES MAY DEPEND ON IT!

CAUTION: USE ONLY CLEAN, DRY, HIGH QUALITY COMMERCIALY MANUFACTURED AMMUNITION IN GOOD CONDITION which is appropriate for your firearm.

DIAMONDBACK does not recommend the use of re-manufactured or hand loaded ammunition because it may damage your firearm.

WARNING: THIS FIREARM COULD CHAMBER A ROUND if it is dropped or jarred with a loaded magazine in place - either with the Bolt Carrier Assembly locked to the rear, or in its forward position.

A SAFETY NOTE REGARDING LEAD... Discharging firearms in poorly ventilated areas, cleaning firearms, or handling ammunition may result in exposure to lead, a substance known to cause birth defects, reproductive harm, and other serious physical injury. Have adequate ventilation at all times. Wash hands thoroughly after exposure.

SERVICE

Should your firearm need adjustment, refinishing, or repair, it should be returned to the factory, **unloaded.**

When shipping the firearm, be sure to adhere to the following rules:

Federal Firearms Licensees are required to send an updated copy of their FFL with the return of a repair.

Firearms and contents must be shipped in a proper cardboard box.

Please do not ship with ammunition, it will not be returned.

You are responsible for knowing your state and federal firearm laws.

Individuals who wish to return the firearm for service can do so by shipping it to the address below. No return authorization number is required.

Any firearm shipped for service must have a child safety lock and key with it. If not, then DIAMONDBACK FIREARMS will include one upon return at the owners expense.

Include a letter of instruction, your full name, address, telephone number, and the firearm's serial number. This will ensure prompt service and handling. Once your firearm has been received, anything other than warranty work will receive a quotation. You will be notified of full charges and no work will commence before your approval of the quote has been obtained.

DIAMONDBACK FIREARMS accepts payments in the form of money orders, American Express, Discover, Mastercard and Visa. Please return your firearm to:

Diamondback Firearms, LLC

Service Dept.

3400 Grissom Pkwy.

Cocoa, FL 32926

1.877.997.6774

WARNING

ALTERATIONS & MODIFICATIONS

Altering or modifying parts is dangerous and will void the product's warranty. This Diamondback Firearms product was manufactured to perform properly with the original parts as designed. It is your duty to make sure any parts you buy are made for this product and are installed correctly and that neither the replacements nor the originals are altered or changed. Your Diamondback Firearms product is a complex, precision tool with many parts whose proper relationships must be maintained for proper and safe operation. Putting a firearm together incorrectly or with improper or modified parts can cause malfunctions which may result in damage to the firearm and/or other personal property and may also result in serious personal injury or death to you and/or others. Always have any work other than what is described in this manual performed by a qualified gunsmith or by Diamondback Firearms; doing otherwise will void your product's warranty.

FIREARMS

DIAMONDBACK FIREARMS, LLC.

LIMITED LIFETIME WARRANTY

This "Limited Lifetime Warranty" has been drafted to comply with the MAGNUSON-MOSS WARRANTY FEDERAL TRADE COMMISSION IMPROVEMENT ACT which is effective for goods manufactured on or after December 31, 1976. DIAMONDBACK FIREARMS, LLC. warrants that this firearm was originally manufactured free from defects in material and workmanship.

DIAMONDBACK FIREARMS, LLC. agrees to correct any defect in material and/or workmanship for the original purchaser by repair or replacement ONLY. Proof of purchase required. A service or handling charge may be applied at the company's discretion.

DIAMONDBACK FIREARMS, LLC. will not be responsible for defects resulting from careless handling, unauthorized adjustments or modifications, corrosion, neglect, abuse, failure to provide reasonable and necessary maintenance as described by this owners manual. Damage caused by hand loaded and/or reloaded or improper ammunition or damage caused from firing with any obstruction in the barrel will not be warranted. This warranty does not apply to ordinary wear and tear of any parts, including metal, plastic, or any other material used to manufacture this product, as well as all surface finishes. Diamondback does not warranty aftermarket parts or damage or issues caused by them.

Under no circumstances shall DIAMONDBACK FIREARMS,LLC. be responsible for incidental or consequential damages with respect to economic loss or injury or property damage, whether as a result of breach of express or implied warranty, negligence or otherwise. Some states do not allow the exclusion or limitation of incidental or consequential damages, so the above limitation or exclusion may not apply in certain cases.

If you need to return your gun to DIAMONDBACK FIREARMS for warranty or service related claims, please refer to the shipping instructions in the SERVICE section of this manual.

This DIAMONDBACK FIREARMS Operating and Safety Instruction Manual should always be kept with your Diamondback Firearm, and in case of sale or transfer, should be passed on to subsequent owners.

Model: _____

Serial Number: _____

Sold To: _____

Date Sold: _____

FIREARMS



USAMADE

DIAMONDBACK

FIREARMS



USAMADE