



SAFETY & INSTRUCTION MANUAL FOR TRADITIONS™ NITROFIRE™



⚠ WARNING: YOU MUST READ THESE INSTRUCTIONS AND WARNINGS CAREFULLY. FAILURE TO READ THESE INSTRUCTIONS AND FOLLOW THESE WARNINGS MAY RESULT IN SERIOUS INJURY OR DEATH TO YOU AND OTHERS AND DAMAGE TO PROPERTY.

The NitroFire™ requires a Form 4473 and is compatible with only the Federal Premium® Firestick™.

This manual may not be reproduced in whole or in part without the express written permission of Traditions™ Performance Firearms.

FIT-75

Rev. 2 07/20 AKH

Traditions™ Performance Firearms
1375 Boston Post Road
P.O. Box 776
Old Saybrook, CT 06475
(860) 388-4656
www.traditionsfirearms.com

Your Muzzleloading Rifle

Congratulations on your purchase of a Traditions™ muzzleloader. You have selected the cutting edge NitroFire™ muzzleloading firearm designed and engineered to give today's shooters the highest performance and optimum accuracy. When given the respect and care that any firearm demands, you can expect many years of reliable service and enjoyable hunting from your new Traditions™ muzzleloader.

The Sport of Muzzleloading

More and more sportsmen have discovered the challenge and enjoyment of muzzleloading in recent years. For both hunting and target shooting, muzzleloading guns have helped a modern generation recapture and enjoy an important aspect of our nation's sporting past.

Traditions™ muzzleloaders represent the latest developments in this unique part of the shooting sports. They are manufactured to modern standards for safe and enjoyable shooting. This booklet is intended as a basic guide for the proper maintenance, loading and shooting of Traditions™ NitroFire™, and it offers important rules and precautions for safe handling and shooting of this type of firearm. In addition to this booklet, it is recommended that the novice obtain further information and instruction before firing a muzzleloader.

Sources for shooting or hunting help include:

1. National Rifle Association <https://home.nra.org/>
2. National Muzzleloading Rifle Association
3. Local sporting goods dealer, State DEP, or conservation department
4. Local muzzleloader or hunting club
5. National Shooting Sports Foundation
<https://www.nssf.org/>

 DANGER: Always keep your firearm pointed in a safe direction with your finger off the trigger until you are ready to fire. Never point a firearm at anything you do not intend to shoot and always be sure of what is beyond your target.

This SAFETY & INSTRUCTION MANUAL should always accompany this firearm and be transferred with it upon change of ownership or when the firearm is presented to another person. This muzzleloader is considered a firearm by ATF regulations and requires a Form 4473.

If you don't have a manual, a printed copy is available free upon request by contacting Traditions™ at the address below. A manual is also available via download at:

www.traditionsfirearms.com

• CUSTOMER SUPPORT •

Traditions™ Performance Firearm

1375 Boston Post Road

P.O. Box 776

Old Saybrook, CT 06475

(860) 388-4656

www.traditionsfirearms.com

TABLE OF CONTENTS

1. YOUR SAFETY RESPONSIBILITIES.....	5
2. SAFE STORAGE & TRANSPORTATION.....	10
3. SAFETY RULES FOR YOUR NITROFIRE™.....	12
4. BASICS OF THE NITROFIRE™.....	15
5. SAFETIES INCLUDED ON YOUR NITROFIRE™.....	18
6. ELITE XT™ SYSTEM.....	19
7. INITIAL CLEANING OF NITROFIRE™.....	20
8. BASIC EQUIPMENT FOR SHOOTING THE NITROFIRE™.....	22
9. CHARGING THE NITROFIRE™.....	23
10. INSTALLING THE FIRESTICK™ & PRIMING THE NITROFIRE™.....	26
11. FIRING YOUR NITROFIRE™.....	27
12. REMOVING THE FIRESTICK™ AFTER FIRING.....	28
13. MISFIRES & HANGFIRES.....	28
14. DECOCKING THE NITROFIRE™.....	30
15. UNLOADING & UNCHARGING THE NITROFIRE™.....	31
16. CLEANING & MAINTENANCE OF THE NITROFIRE™.....	32
17. DISASSEMBLY, DETAILED CLEANING, & REASSEMBLY.....	34
18. SCOPE MOUNTING & SIGHTING IN.....	40
19. INFO ON PROJECTILES, FIRESTICKS, AND PRIMERS.....	42
20. WARRANTY & SERVICE.....	44

If you still have questions after reading this manual completely, please contact our customer service department at 860-388-4656 or view our how-to videos at <https://www.traditionsfirearms.com> and <https://www.youtube.com/TraditionsFirearm>

1. YOUR SAFETY RESPONSIBILITIES

SAFETY IS YOUR NUMBER ONE RESPONSIBILITY!!!!

No matter if you are at home, in the field, at the range, or anywhere; your primary concern as a firearm owner must always be safety. You must always apply the following safety rules in every situation with any kind of firearm regardless of setting. If you feel unsure about any aspect of your firearm or its operation, please contact Traditions™ before using it.

 WARNING: YOU MUST FOLLOW ALL OF THESE SAFETY RULES TO ENSURE THE SAFE USE OF YOUR FIREARM. THE FAILURE TO FOLLOW THE INSTRUCTIONS AND WARNINGS IN THIS MANUAL COULD CAUSE SERIOUS PERSONAL INJURY OR DEATH TO YOU OR OTHERS AND DAMAGE TO PROPERTY.

When you become a firearm owner, you take on a serious and demanding responsibility. How seriously you take this responsibility can be the difference between life and death. There is no excuse for reckless or abusive handling of your firearm. At all times you must handle your firearm with an intense respect for its power and potential danger.

 WARNING: YOU ARE RESPONSIBLE FOR THIS AND ALL YOUR FIREARMS AT ALL TIMES. In owning a firearm, you have a constant responsibility for your firearm's safety and security. You must always protect yourself and all others against injury or death from misuse of the firearm 24 hours a day, 7 days a week, 365 days a year. This responsibility is not something you can ever neglect.

 WARNING: ALWAYS BE SURE OF YOUR TARGET AND WHAT IS BEYOND IT. Always know where a bullet you fire will hit and shoot only where there is a safe back stop free of any obstructions. Bullets can bounce or ricochet off many surfaces like rocks or the surface of water and travel in unpredictable directions with considerable velocity creating dangerous situations. NEVER fire randomly into the sky.

 WARNING: NEVER SOLELY RELY ON MECHANICAL FEATURES SUCH AS A SAFETY. Mechanical features such as safeties can fail and should never be relied upon with disregard to proper safe firearms handling. Only by following the safe firearms handling procedures in this manual will the safe use of your firearm be assured. You are responsible for always following these safe firearm handling rules. Mechanical safeties in firearms are aides in establishing a more convenient operating system but are never replacements for safe handling on the part of the shooter.

 **WARNING: ALWAYS WEAR EYE AND EAR PROTECTION THAT ARE SPECIFIED FOR USE WITH FIREARMS** every time you handle your firearm for loading, firing, cleaning, or maintenance. Make sure that all bystanders where you will be shooting are also wearing the proper eye and ear protection.

 **WARNING: ALWAYS HAVE ADEQUATE VENTILATION WHEN DISCHARGING A FIREARM.** Discharging a firearm in poorly ventilated areas, cleaning firearms, or handling ammunition and loading components may result in exposure to lead and other substances known to cause birth defects, reproductive harm, and other serious physical injuries. Review the warnings and labels for all ammunition, loading components, and cleaning products carefully. Wash hands thoroughly after exposure.

 **WARNING: NEVER ALLOW THIS FIREARM TO BE USED BY ANYONE WHO DOES NOT UNDERSTAND ITS SAFE OPERATION OR HAS NOT READ THIS MANUAL IN ITS ENTIRETY.**

 **WARNING: NEVER DISASSEMBLE YOUR FIREARM** beyond the instructions outlined in this manual. Improper disassembly or re-assembly of your firearm may create a dangerous situation which can lead to serious injury or death to you or others or the destruction of property.

 **WARNING: NEVER MANIPULATE, ADJUST, OR ALTER ANY OF THE INTERNAL COMPONENTS OF YOUR FIREARM.** Improper manipulation or alteration of any internal component may affect the safety and reliability of your firearm and create a situation where serious injury or death could occur. In addition, do not replace any of the parts in your firearm with anything other than genuine Traditions™ parts. The use of non-Traditions™ parts will void all warranties. Any alteration or replacement of parts in your Traditions™ firearm not performed by a qualified gunsmith using genuine Traditions™ parts may cause death, personal injury, or property damage. NOTE: Altering the factory-standard mechanical function of your firearm will VOID your warranty and could lead to unsafe handling and function of the firearm.

 **WARNING: DO NOT DRILL HOLES IN THE BARREL AS THIS COULD WEAKEN THE BARREL STRUCTURE LEADING TO A RUPTURE. A RUPTURED BARREL CAN CAUSE SERIOUS INJURY AND/OR DEATH TO THE SHOOTER OR BYSTANDERS AND DAMAGE TO PROPERTY. DRILLING HOLES IN THE BARREL VOIDS ALL WARRANTIES.**

 **DANGER: SAFE FIREARMS HANDLING IS YOUR PERSONAL RESPONSIBILITY ALWAYS.** Firearms have the potential to be dangerous resulting in serious injury or death if they are misused or handled inappropriately. Safety must always be the primary concern of anyone who owns or handles firearms. Accidents are the result of violating the rules of safe firearm handling. Professional firearm safety training is available to supplement the safety instruction in this manual. Some examples of organizations to contact are your local firearms dealer, state conservation department, hunter safety department, law enforcement agency, local sportsman's club, the National Shooting Sports Foundation (NSSF), and the National Rifle Association (NRA) for availability of firearms training.

 **DANGER: ALWAYS TREAT EVERY FIREARM AS IF IT IS LOADED AND WILL FIRE.** Never assume or take anyone's word that the firearm is uncharged or unprimed. You must always physically check for yourself. Never pass a loaded firearm to another person. You must first open the action then visually check that the firearm is uncharged and unprimed before passing the firearm to another person. Keep your firearm uncharged, unprimed, not cocked, with no bullet in the barrel, and safely stored when not in use.

 **DANGER: NEVER PLACE YOUR FINGER INSIDE THE TRIGGER GUARD OR ON THE TRIGGER UNLESS YOU INTEND TO FIRE.** Always keep your finger off the trigger until your sights are on the target and you are prepared to fire. Also make sure that other objects do not touch the trigger at any time.

 **DANGER: ALWAYS KEEP YOUR FIREARM POINTED IN A SAFE DIRECTION.** Never point the muzzle of a firearm at anyone or anything you do not intend to shoot. Many incidents have occurred because people pointed what they thought was an unloaded firearm in an unsafe direction. This is especially important when loading, unloading, or field stripping the firearm. ALWAYS control the direction of the firearm.

 **DANGER: NEVER CROSS ANY OBSTACLES SUCH AS FENCES OR STREAMS WITH A FIRESTICK™ IN YOUR MUZZLELOADING FIREARM.** This rule should always be followed before crossing a fence, climbing a tree, jumping a ditch, or negotiating any other obstacles.

 **DANGER: ALWAYS REMOVE THE FIRESTICK™ FROM THE BREECH BEFORE YOU CLIMB TO OR DESCEND FROM A TREE STAND. NEVER RAISE OR LOWER A NITROFIRE TO OR FROM A TREESTAND WITH A FIRESTICK™ IN THE BREECH.** Failure to follow this rule may cause serious injury and/or death to the shooter or bystanders and damage to property.

⚠ DANGER: NEVER LEAN A FIRESTICK™ CHARGED NITROFIRE™ AGAINST A TREE, A WALL, OR ANY SURFACE WHERE IT MAY FALL OVER. Once your NitroFire™ has had a Firestick™ inserted it is your responsibility to protect against any situation that may result in an accidental discharge. Failure to follow this rule may cause serious injury and/or death to the shooter or bystanders and damage to property.

⚠ DANGER: NEVER UNDER ANY CIRCUMSTANCES USE ALCOHOL OR DRUGS BEFORE OR WHILE SHOOTING. In addition, do not use your firearm if you are on any medication which impairs, even slightly, your mental or physical ability. You should also not use your firearm if you are excessively tired, distracted, or impaired in any way. You need to be alert and have your full attention devoted to the safe use of the firearm.

⚠ DANGER: ALWAYS USE THE CORRECT FIRESTICK™ AND APPROVED BULLETS FOR YOUR NITROFIRE™ AS DETAILED IN THIS MANUAL.

⚠ WARNING: NEVER ATTEMPT TO DISCHARGE A NITROFIRE™ WITH ANY CARTRIDGE OR RELOADED FIRESTICK™.

⚠ DANGER: MAKE CERTAIN THE BARREL IS CLEAR OF ANY OBSTRUCTIONS BEFORE SHOOTING. Dirt, water, snow, and other objects may inadvertently become lodged in the bore of the barrel. A small obstruction can cause a dangerous increase in pressure and may damage your firearm and cause injury or death to you or bystanders. Refer to the cleaning section of this manual for instructions on how to remove any obstructions in the barrel.

⚠ CAUTION: BEFORE HANDLING ANY FIREARM, UNDERSTAND ITS OPERATION. Not all firearms are the same and some have features and mechanical operation unique to that specific firearm. Before using a firearm you should learn the mechanical features of the specific firearm you intend to use. If you feel unsure about any operational aspects of this firearm, please contact Traditions™ before proceeding with its operation.

⚠ WARNING: This product can expose you to chemicals including lead, which is known to the State of California to cause cancer and birth defects or other reproductive harm. For more information go to www.P65Warnings.ca.gov.

APPROPRIATE USE FOR YOUR FIREARM MEANS USING YOUR FIREARM FOR LEGAL PURPOSES. It is your responsibility to ensure that you are in compliance with all applicable Federal, State, and Local laws and ordinances regarding the use of your firearm.

MAKE SURE THAT SLINGS, SCOPES, AND ANY OTHER ACCESSORIES ARE COMPATIBLE with the firearm and that they do not interfere with the safe operation of the firearm. It is your responsibility to understand and follow all instructions in this manual, as well as those which may be supplied with your ammunition and loading components and any accessory and how they all relate to each other.

 **DANGER: BEFORE YOU ACCEPT A FIREARM FROM SOMEONE, CONFIRM FOR YOURSELF THAT IT IS UNLOADED.**
Treat all firearms as if they are loaded and will fire.

 **DANGER: NEVER LEAVE A LOADED FIREARM UNATTENDED.**

 **CAUTION: DO NOT ATTEMPT TO SHOOT OR LOAD YOUR FIREARM UNTIL YOU HAVE READ THIS MANUAL COMPLETELY AND FULLY UNDERSTAND IT. FAILURE TO READ AND FOLLOW THESE INSTRUCTIONS COULD RESULT IN INJURY AND/OR DEATH TO THE SHOOTER OR BYSTANDERS AND DAMAGE TO PROPERTY. IF YOU ARE UNABLE TO UNDERSTAND ANY OR ALL OF THIS MANUAL, CALL THE CUSTOMER SERVICE DEPARTMENT AT TRADITIONS™.**

USE TRADITIONS™ SCOPE MOUNTS ONLY. All current Traditions™ rifles come drilled and tapped for use with scopes. Traditions™ offers a wide variety of scopes, scope mounts, and rings in varying sizes and finishes to suit your needs. When mounting a scope use only Traditions™ mounts to ensure proper fit and function. Traditions™ mounts are specifically made to fit these pre-drilled existing holes in your firearm.

2. SAFE STORAGE & TRANSPORTATION

 **WARNING: FIREARM SECURITY IS YOUR PERSONAL RESPONSIBILITY. ALWAYS SAFELY STORE AND SECURE YOUR FIREARM.** You must ensure that your firearms are securely and safely stored so that children and/or unauthorized users may not obtain them. Your firearms should always be kept unloaded and locked when not in use or in your immediate control. Never assume that the use of a lock alone is sufficient to safely secure your firearm. You must continually evaluate your personal situation and employ security systems that prevent children and unauthorized users from gaining access to your firearm. It is recommended that you secure bullets, Firesticks, and primers in a locked container separate from your firearms.

 **WARNING: DO NOT LOAD UNTIL READY TO DISCHARGE YOUR NITROFIRE™.**

 **WARNING: FIREARMS ARE DANGEROUS IF THEY ARE USED AND/OR STORED IMPROPERLY. THEY POSE A RISK OF SERIOUS OR FATAL INJURIES. FIREARMS CAN BE ESPECIALLY DANGEROUS TO CHILDREN WHEN THEY ARE STORED IN AN IRRESPONSIBLE AND UNSAFE MANNER. FOR YOUR SAFETY AND THE SAFETY OF OTHERS, IT IS IMPERATIVE THAT YOU KEEP YOUR FIREARM LOCKED AND UNLOADED IN A SECURE PLACE. THE AMMUNITION OR LOADING COMPONENTS SHOULD BE STORED IN A SEPARATE, LOCKED, SECURE LOCATION WHEN NOT IN USE. SAFE AND SECURE STORAGE OF YOUR FIREARM IS ONE OF THE MOST IMPORTANT RULES OF FIREARM SAFETY. YOUR FAILURE TO FOLLOW THESE RULES MAY RESULT IN SERIOUS INJURY OR DEATH TO YOU OR OTHERS.**

 **WARNING: ALWAYS SECURE YOUR FIREARM IN A MANNER THAT WILL PREVENT UNAUTHORIZED ACCESS.** Whenever you are not using your firearm it should be kept unloaded and locked. Your own safety and the safety of others demands that you always secure and store your firearm in a way that will prevent unauthorized access. Never leave a firearm unattended unless it is unloaded, locked, and secured.

 **WARNING: MAKE SURE TO CHECK TWICE THAT YOUR FIREARM IS UNLOADED BEFORE TRYING TO INSTALL ANY LOCKING DEVICE.**

 **WARNING: NEVER TRANSPORT A NITROFIRE™ WITH A FIRESTICK™ INSTALLED.** When transporting your firearm it must not have a bullet or Firestick™ installed and be securely locked. Safe and secure transportation of your firearm is another important aspect of your responsibility as a firearm owner.

 **DANGER: NEVER STORE A NITROFIRE™ WITH A BULLET OR FIRESTICK™ INSTALLED.** When storing your firearm it must be empty and securely locked. If you fail to follow this instruction you may experience a double load or fire the muzzleloader thinking it is unloaded.

 **WARNING: IF A PRIMER IS DROPPED IT MAY EXPLODE AND CAUSE INJURY AND/OR DEATH TO THE SHOOTER OR BYSTANDERS AND DAMAGE TO PROPERTY. IF A FIRESTICK WITH A PRIMER INSTALLED IS DROPPED IT MAY EXPLODE AND CAUSE INJURY AND/OR DEATH TO THE SHOOTER OR BYSTANDERS AND DAMAGE TO PROPERTY.**

 **CAUTION: ALWAYS STORE YOUR FIREARM AND AMMUNITION AND LOADING COMPONENTS SEPARATELY** so that they are not accessible to children or other unauthorized persons. Safe and secure storage of your firearm, ammunition, and loading components is your responsibility.

 **CAUTION: NEVER ASSUME THAT A "SECRET LOCATION" OR "HIDING PLACE" IS A SECURE STORAGE METHOD.** Without your knowledge others, such as children, may be aware of your storage location or they may find it by accident. It is your responsibility to properly store your firearms and ammunition/Firesticks™ and to always make sure they are not accessible to children or unauthorized persons.

 **CAUTION: ALWAYS FOLLOW THE LAW!** In many states and local municipalities there are laws and regulations that make it a crime to keep a firearm unlocked in an area that is accessible to children or others. Keeping a firearm locked and unloaded when not in use is not only a common sense safety practice... IT IS THE LAW. You must be familiar with all local, state, and federal laws regarding the safe storage and transportation of your firearm. Failure to know and follow the law may result in unauthorized access or use of your firearm by another for which you may be held accountable. Obey all laws relating to the storage and transportation of firearms. Your local police department or gun shop can provide you with the pertinent information for where you live on storing and/or transporting a firearm safely and legally.

3. SAFETY RULES FOR YOUR TRADITIONS™ NITROFIRE™

In addition to the general Firearm Safety Responsibilities covered so far in this manual, there are additional guidelines specific to the NitroFire™ muzzleloading firearm that must be adhered to at all times to ensure the safety of the shooter and others.

 **WARNING: UNDERSTAND THE TERMINOLOGY REGARDING LOADING.** When speaking of a NitroFire™ firearm “Charge” or “Charged” refers to the presence of a Firestick™ and projectile in the bore of the firearm.

“Uncharge” or “Uncharged” indicates that the Firestick™ and projectile have been either fired or removed and that the bore is completely clear.

“Prime” or “Primed” applies to the act of placing a primer in the Firestick™ in a NitroFire™.

“Unprime” or “Unprimed” indicates that the primer has been removed from the Firestick™ or is not in place.

 **DANGER: USE ONLY FACTORY NEW FIRESTICKS IN YOUR TRADITIONS™ NITROFIRE™.** Never load any powder between the bullet and Firestick™. The use of any other propellant between the bullet and Firestick™ will cause injury and/or death to the shooter or bystanders and damage property.

 **DANGER: NEVER SMOKE OR ALLOW BYSTANDERS TO SMOKE WHILE USING YOUR NITROFIRE™.** The spark from a lighted cigarette, cigar, or pipe can ignite a Firestick™ or Primers. Smoking around a charged and/or primed muzzleloader, Firestick™, or primers may cause premature firing of the firearm or an explosion causing serious injury and/or death to the shooter or bystanders and damage to property.

 **DANGER: DO NOT LOAD A NITROFIRE™ WHICH IS HOT FROM PREVIOUS FIRING.** Always allow the barrel to cool before you begin reloading your muzzleloading firearm.

⚠ DANGER: BEFORE YOU BEGIN LOADING, MAKE SURE YOUR NITROFIRE™ DOES NOT HAVE A FIRESTICK IN THE CHAMBER OR A BULLET IN THE BARREL. To make sure the NitroFire™ is uncharged, keep the muzzle pointed in a safe direction and open the breech. Look down the barrel from the breech to confirm there is no Firestick™ or bullet. You can also run a ramrod down the barrel from the breech.

⚠ DANGER: WHEN LOADING, MAKE SURE THAT THE PROJECTILE IS FIRMLY SEATED AGAINST THE BULLET SHELF. Serious personal injury or death can result if the projectile is not seated properly against the shelf. A simple way to check this when loading is after you have fully seated a projectile against the shelf mark the ramrod as a point of reference for a properly seated projectile.

⚠ DANGER: NEVER EXCEED THE RECOMMENDED BULLET WEIGHT LISTED ON TRADITIONSFIREARMS.COM. If the recommended bullet weight is exceeded then injury AND/or death to the shooter or bystanders and damage to property can occur.

⚠ DANGER: NEVER INSERT A FIRESTICK™ OR PRIME YOUR NITROFIRE™ UNTIL YOU ARE READY TO FIRE. After you've primed the Firestick™ your full attention should be on the target and firing of the firearm.

⚠ DANGER: NEVER PASS A CHARGED NITROFIRE™ TO ANOTHER PERSON. Once charged, a muzzleloading firearm requires your complete attention. Never charge the firearm and then hand it to another shooter. You should also never shoot a muzzleloading firearm that was charged by someone else. Only the person who actually performed the loading knows whether the firearm has been charged properly and should fire it.

⚠ DANGER: BEFORE YOU ACCEPT A NITROFIRE™ FROM SOMEONE, CONFIRM FOR YOURSELF THAT IT IS UNPRIMED, UNCHARGED, AND CONTAINS NO BULLET. Treat all firearms as if they are loaded and will fire.

⚠ DANGER: WHILE SHOOTING ALWAYS KEEP SUPPLIES OF FIRESTICKS AND PRIMERS WELL AWAY FROM YOUR FIRING POSITION OR SHOOTING BENCH. A Firestick™ or quantity of primers can ignite with deadly force if exposed to sparks or intense heat. Follow the manufacturer's instructions for safe handling and storage of Firesticks and primers. Keep unused Firesticks and primers well away from firearms that are being discharged. Sparks from the discharge of a NitroFire™ may cause the unused supply of Firesticks and primers to ignite causing serious injury and/or death to the shooter or bystanders and damage to property.



CAUTION: ALL PROPELLANTS INCLUDING FIRESTICKS MAY LEAVE RESIDUES IN THE BORE AND ON THE NITROFIRE™ THAT REQUIRE CLEANING.

A thorough in-depth cleaning is required before storage for any amount of time to keep the firearm functioning properly and in a safe condition. Failure to properly clean the firearm may prevent the firearm from functioning safely and correctly and may result in injury and/or death to the shooter or bystanders and damage to property.

You must follow these procedures every time a firearm leaves your hand, is cleaned, handed to you or another person, transported or stored.

4. LEARNING THE BASICS OF THE TRADITIONS™ NITROFIRE™

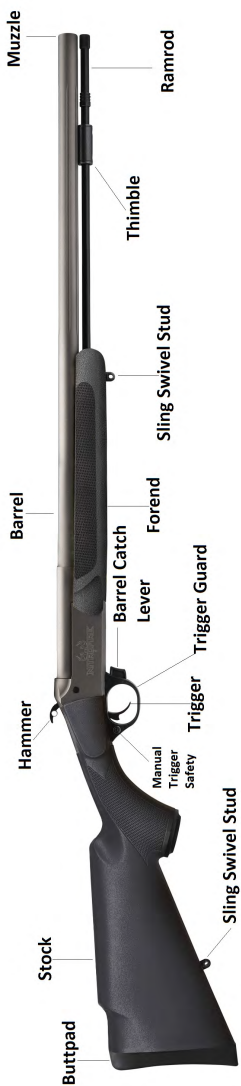

Model Name & Caliber Designation on the Barrel



Serial Number Marking on the Frame

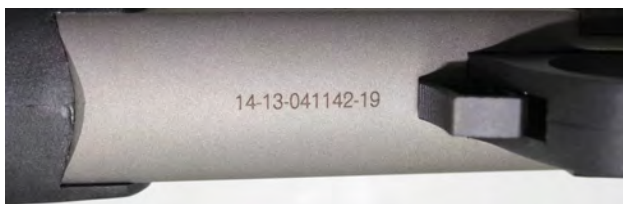

Models:

CR841140NS

Cal. .50 / SS Cerakote / 26" Barrel

Rev.B

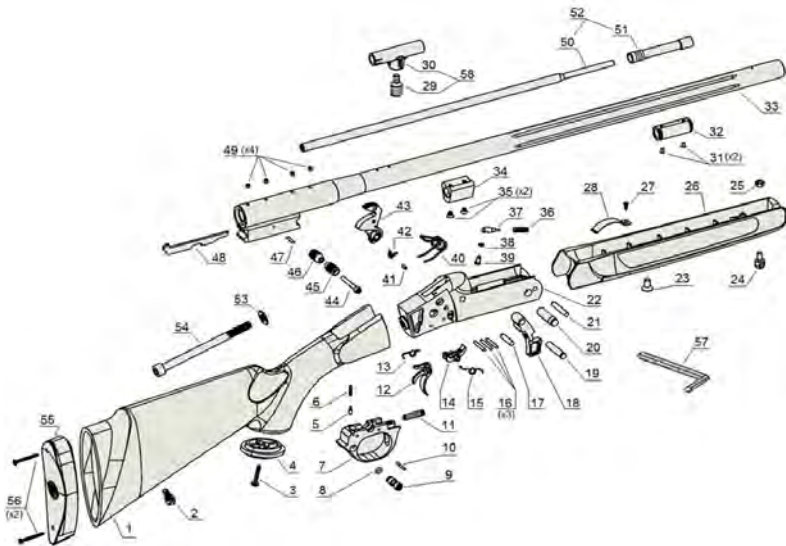

N.	DESCRIPTION	REF.
1	Stock	FC5701070-2
2	Sling Swivel Stud-Rear	37223
3	Pistol grip Cap Screw	50105
4	Pistol grip Cap	50104
5	Ball	71000
6	Trigger Guard Spring	M71015
7	Trigger Guard	M810027
8	O-Ring	71030
9	Safety	710032
10	Safety Pin	M710029
11	Barrel Catch Spring	M72017
12	Trigger	81003
13	Trigger Spring	M81016
14	Sear	M81001
15	Sear Spring	M81015
16	Trigger Guard and Trigger Pin(x3)	M710025
17	Hammer Pin	M710031
18	Barrel Catch Lever	N/A
19	Barrel Catch Pin	357023
20	Frame Pivot Pin	300024
21	Extractor Pin	357026
22	Frame	N/A
23	Forend Stock Screw	10034
24	Fore Stock Sling swivel Stud	37022
25	Sling Swivel Stud Nut	60122
26	Fore Stock	FC5741070-1
27	Ramrod Retaining Spring Screw	21817
28	Ramrod Retaining Spring	400030
29	Quick-T Jag	560028

N.	DESCRIPTION	REF.
30	Handle	560014
31	Ramrod Thimble Screw (x2)	400031
32	Ramrod Thimble	400032
33	Barrel Assembly	FB841130
34	Tenon	330023
35	Tenon Screw (x2)	330022
36	Firing Pin Spring	M10011
37	Firing Pin	82007
38	Firing Pin Screw Washer	M71020
39	Firing Pin Screw	730021
40	Hammer Spring	M81017
41	Hammer Return Pin	M81013
42	Hammer Return Spring	M81014
43	Hammer	82002
44	Handle Extension Screw	M4503
45	Hammer Extension	4502
46	Hammer Extension Nut	4501
47	Extractor plunger Pin	M35000
48	Extractor plunger	81000
49	Plug Screw (x4)	26029
50	Ramrod 26" (Aluminum)	110030
51	Ramrod Tip .50 Cal (Aluminum)	100028
52	RamRod Assembly	110011
53	Tang Screw Washer	M71019
54	Tang Screw	M71016
55	Buttpad	74026
56	Buttpad Mounting Screw (x2)	20634
57	Allen Wrench	M1005
58	Quick-T Assembly	1595

© 2020 Traditions™ Performance Firearms. All Rights Reserved.

5. SAFETIES INCLUDED ON TRADITIONS™ NITROFIRE™

Your Traditions™ NitroFire™ comes equipped with dual safeties.

The first safety is an internal passive hammer block that prevents the hammer contacting the firing pin until the trigger is pulled.

Internal Rebounding Hammer Block Safety



When the hammer is in the **At Rest** position the internal hammer block safety is preventing the hammer from striking the firing pin unless the manual trigger safety is disengaged and the trigger is pulled. Note: There should be a small gap between the hammer and frame in this position.



When the hammer is in the **Full Cock** position - internal hammer block safety moves into a lower position.

The second safety is an ambidextrous mechanical manual trigger block safety that prevents the trigger from being pulled back and allowing the sear to become disengaged.

Manual Trigger Safety



Manual Trigger Safety **disengaged or the "safety off."** If the red ring is visible, the firearm is no longer safe and is ready to fire.



Manual Trigger Safety **engaged or the "safety on."** Firearm is in the safe position if no red ring is visible.

© 2020 Traditions™ Performance Firearms. All Rights Reserved.

6. THE NITROFIRE™ ELITE XT™ SYSTEM

The NitroFire™ is equipped with the Elite XT™ trigger and hammer system. This system has a precise and accurate trigger pull. It is designed with a rebounding hammer and a manual trigger safety. There are 2 positions the hammer can be in with the Elite XT™ system:

The At Rest Position

This position is where the hammer is sitting off of the firing pin and there is a slight gap between the hammer and the top of the frame. After the NitroFire™ is fired, the rebounding hammer should return to the At Rest position. Even in the At Rest Position, we recommend the manual trigger safety be engaged so the red ring is not visible until you are ready to cock the hammer on the NitroFire™.



The Full Cock Position

In this position, the action will be locked and the NitroFire™ cannot be broken open. This should only be performed when ready to fire. The hammer should be pulled fully rearward and you should feel the hammer lock into place. The NitroFire™ is now in the ready-to-fire position and once the manual trigger safety is disengaged so the red ring is visible, the trigger can be pulled and the NitroFire™ will fire. See p. 29 for more information on firing the NitroFire™.



7. INITIAL CLEANING OF THE NITROFIRE™

⚠ WARNING: Confirm that the firearm is unloaded before any cleaning and that the manual trigger safety is in the "safe" position.

CAUTION: When performing the initial cleaning be mindful to always point the barrel in a safe direction and not towards any hard surface. Treat every firearm as if it were loaded and can fire at any time.

NOTE: BEFORE YOUR INITIAL USE CLEAN AND LUBRICATE YOUR NITROFIRE™!

These are brief instructions on what to do before you use your NitroFire™ for the first time. Please review the disassembly instructions on page 36 for the complete set of cleaning instructions. When you remove your new NitroFire™ from the box there may be residues that need to be removed before shooting.

1. Remove the ramrod.

2. With the action closed, unscrew the forend screw using the supplied 4mm wrench and remove the forend from the barrel.



3. Open the action by pulling the barrel catch lever which will then allow the action to pivot open.

4. Remove the barrel from the frame by pushing the barrel catch lever in. When the action starts to open lift the barrel up and out of the frame. Clean all items with hot, soapy water or bore solvent such as Traditions™ EZ Clean. This will remove any manufacturing residue that may be on the inside or outside of the barrel.



5. Dry all of the parts completely.
6. Apply a light coat of Traditions™ EZ Clean solvent to a dry patch (or use Traditions™ pre-soaked EZ Clean patches). Install a cleaning jag on your ramrod and place the patch over the jag. Run the patch up and down the bore. Do not push past the shelf.



7. Use the Traditions™ Cleaning & Seasoning Patches or Traditions™ Wonderlube pre-lubed patches to "season" the lands and grooves of the rifling before loading. This will allow for easier loading and cleaning throughout your shooting sessions. Do not push past the shelf.



8. Repeat the process from the breech to clean the chamber area. Do not push past the shelf.
9. Now reassemble your firearm.

A NOTE ABOUT MAINTENANCE PROCEDURES:

Proper maintenance and cleaning of your new NitroFire™ will require you to remove the barrel from the frame. You must clean the NitroFire™ each time it is used.

Please refer to the Cleaning & Maintenance section for more information. Take time before such cleaning to study the Disassembly/Assembly procedures and the accompanying photographs to thoroughly acquaint yourself with your rifle's subassemblies.

8. BASIC EQUIPMENT FOR SHOOTING THE NITROFIRE™

 **CAUTION: DO NOT ATTEMPT TO FIRE OR LOAD YOUR NITROFIRE™ UNTIL YOU HAVE READ THIS MANUAL COMPLETELY AND FULLY UNDERSTAND IT. FAILURE TO READ AND FOLLOW THESE INSTRUCTIONS COULD RESULT IN INJURY AND/OR DEATH TO THE SHOOTER OR BYSTANDERS AND DAMAGE TO PROPERTY. IF YOU ARE UNABLE TO UNDERSTAND ANY OR ALL OF THIS MANUAL, CALL THE CUSTOMER SERVICE DEPARTMENT AT TRADITIONS™.**

In order to fire your Traditions™ NitroFire™ you will need the following accessories or equipment listed below:

1. Proper eye protection specified for use with firearms.
2. Proper ear protection specified for use with firearms.
3. Firestick™ encapsulated powder charge in the recommended grain weight. **Note: Only use factory new Firesticks.**
4. 209 Primers (We recommend Federal 209 Muzzleloading Primers)
5. Projectiles appropriate for your NitroFire™ such as Traditions™ Smackdown® bullets. **(Do not use projectiles not recommended by Traditions)**
6. .50 Caliber Bore cleaning patches for muzzle
7. 2.5" cleaning patches for chamber
8. Caliber-specific cleaning jag
9. An appropriate bore cleaner for muzzleloaders such as BlackOut 209™.
10. An appropriate oil or rust inhibiting lubricant such as EZ Clean™ 2 Seasoning Patches or Wonderlube™.
11. NitroFire™ Unloading Jag.
12. NitroFire™ Nylon Cleaning Brush
13. NitroFire™ Bronze Cleaning Brush
14. NitroFire™ Chamber Cleaning Brush
15. While not required, Traditions™ highly recommends a loading/cleaning rod such as Traditions™ Ultimate Loading/Cleaning Rod which will make loading and cleaning easier.

9. CHARGING THE NITROFIRE™

⚠ DANGER: ALWAYS POINT THE MUZZLE IN A SAFE DIRECTION AND DO NOT HAVE ANY PART OF YOUR BODY OVER THE MUZZLE WHEN LOADING.

⚠ DANGER: BEFORE YOU BEGIN LOADING, MAKE SURE YOUR NITROFIRE™ DOES NOT HAVE A FIRESTICK IN THE CHAMBER OR A BULLET IN THE BARREL. To make sure the NitroFire™ is uncharged, keep the muzzle pointed in a safe direction and open the breech. Look down the barrel from the breech to confirm there is no Firestick™ or bullet. You should also run a ramrod down the barrel from the breech.

PREPARING TO LOAD THE BULLET

⚠ WARNING: WEAR PROPER EYE PROTECTION FOR THE ENTIRE LOADING PROCESS.

Prior to loading, you must first ensure that the firearm is uncharged, unprimed, and the barrel is free of any obstructions.

The easiest way to achieve this is to open the breech and look down the barrel to see if there is a Firestick™, bullet or any obstruction in the barrel.

You may also use the following instructions to ensure the firearm is uncharged and unprimed.

1. Push the safety button to "safe" so that no red ring is visible on the safety button.
2. Remove the ramrod from the thimbles.
3. Unscrew the jag from the ramrod and reverse the jag 180 degrees so that the concave (hollowed end) is exposed.
4. Re-thread the jag so that the concave (hollowed end) is out. This will make the ramrod longer and provide the proper length.



© 2020 Traditions™ Performance Firearms. All Rights Reserved.

LOADING THE PROJECTILE:

⚠ WARNING: THE BULLET MUST ONLY BE LOADED INTO AN EMPTY BARREL FROM THE MUZZLE. CHECK THE BREECH CHAMBER AND BARREL TO BE SURE IT IS CLEAR OF ANY OBSTRUCTIONS. THERE MUST BE NO FIRESTICK™ INSTALLED OR INJURY AND/OR DEATH TO THE SHOOTER OR BYSTANDERS AND DAMAGE TO PROPERTY MAY OCCUR.

⚠ WARNING: DO NOT LOAD OR FIRE ANY PROJECTILES THAT ARE NOT APPROVED BY TRADITIONS FIREARMS DUE TO EXCESSIVE PRESSURES. INJURY AND/OR DEATH TO THE SHOOTER OR BYSTANDERS AND DAMAGE TO PROPERTY MAY OCCUR. VISIT WWW.TRADITIONSFIREARMS.COM.

⚠ WARNING: DO NOT USE PATCHED ROUND BALLS, CONICALS, OR MINIE BALLS.

⚠ WARNING: BE SURE ONLY ONE PROJECTILE IS LOADED IN THE BARREL. DO NOT LOAD A PROJECTILE ON TOP OF ANOTHER. INJURY AND/OR DEATH TO THE SHOOTER OR BYSTANDERS AND DAMAGE TO PROPERTY MAY OCCUR.

⚠ WARNING: NEVER LOAD A PROJECTILE IF THERE IS A FIRESTICK™ IN THE CHAMBER.

⚠ WARNING: NEVER LOAD A BULLET FROM THE BREECH. INJURY AND/OR DEATH TO THE SHOOTER OR BYSTANDERS AND DAMAGE TO PROPERTY MAY OCCUR.

TRADITIONS™ SMACKDOWN® SABOTED BULLETS:

The plastic material used in Traditions™ sabots is self-lubricating. Therefore you do not need to pre-lube your bullets or sabots. NOTE: Always follow the bullet manufacturer's loading instructions.

1. Insert the base of the bullet into the sabot, making certain the bullet is firmly and fully seated against the bottom of the sabot.
2. Place the assembled projectile into the muzzle.
3. Start the projectile with your thumb.
4. Using a ball starter, place the shaft on top of the bullet and push it downward until the starter hits the top of the muzzle.



5. With the concave end of the loading jag on your ramrod, position the ramrod on top of the bullet inside the bore. Holding the ramrod no further than 6" over the bore, apply firm pressure downward until the bullet is seated against the shelf. (Holding the ramrod higher will increase your chances of breaking your ramrod.)



⚠ WARNING: WE RECOMMEND THAT ANY TIME YOU CHANGE TO A DIFFERENT PROJECTILE IN THE NITROFIRE™ THAT YOU FOLLOW THIS PROCEDURE. WE RECOMMEND THE USE OF A NEW RAMROD WITH A MARK SOLELY FOR THAT SPECIFIC BULLET.

6. To avoid the dangers of loading more than one bullet, the first time you load your NitroFire™ you must insert the ramrod and mark the bullet seated location.
7. Make sure to remove the ramrod from the barrel before firing the NitroFire™.



IMPORTANT: ALWAYS SEAT THE BULLET FIRMLY ON TOP OF THE BARREL SHELF. FAILURE TO DO SO MAY RESULT IN INJURY AND/OR DEATH TO THE SHOOTER OR BYSTANDERS AND DAMAGE TO PROPERTY MAY OCCUR.

MARKING THE RAMROD TO SHOW WHEN THE NITROFIRE™ HAS A PROPERLY SEATED BULLET WILL ALLOW THE USER TO KNOW IF THE NITROFIRE™ HAS BEEN DOUBLE LOADED OR IF THE BULLET IS NOT SEATED ALL THE WAY AGAINST THE SHELF.

10. INSTALLING & PRIMING THE FIRESTICK™

⚠ DANGER: ALWAYS POINT THE MUZZLE IN A SAFE DIRECTION AND DO NOT HAVE ANY PART OF YOUR BODY OVER THE MUZZLE WHEN LOADING.

⚠ WARNING: FOLLOW MANUFACTURER'S WARNINGS & RECOMMENDATIONS WHEN INSTALLING THE FIRESTICK & PRIMER.

⚠ WARNING: DO NOT LOAD A FIRESTICK™ OR PRIME YOUR NITROFIRE™ UNTIL IMMEDIATELY BEFORE YOU ARE PREPARED TO FIRE.

⚠ WARNING: WEAR PROPER EYE PROTECTION WHEN LOADING.

1. Point the NitroFire™ in a safe direction at all times.
2. Make sure the hammer is in the At Rest Position and that the manual trigger safety is engaged so the red ring is not visible.

⚠ WARNING: BE SURE THE FIRESTICK™ IS CLEAN & UNFIRED BEFORE LOADING INTO THE BREECH.

⚠ WARNING: DO NOT LOAD OR USE ANY DEFORMED FIRESTICK™. DO NOT RELOAD A NEW OR USED FIRESTICK™.

3. Keeping the NitroFire™ pointed in a safe direction, open the action to expose the breech area. Install a Firestick into the chamber area. Make sure it is fully seated.



⚠ WARNING: DO NOT USE ANY PRIMER OTHER THAN THE RECOMMENDED FACTORY LOADED 209 MUZZLELOADING PRIMER.

4. Install a 209 primer into the primer pocket of the Firestick™.
5. Close up your NitroFire™. You should hear a metallic click and the barrel catch lever should be fully forward. Your NitroFire™ is now charged and primed.



⚠ WARNING: NEVER FORCE THE ACTION CLOSED. The action should close smoothly without resistance and should be fully closed before firing. If the action is not fully closed, the firearm will not function properly. Be sure the Firestick™ is fully seated in the chamber and the primer is fully seated into the primer pocket of the Firestick™. Check to be sure the frame is clean without any obstructions. Never continue to use your firearm if it is not functioning properly. Stop immediately. If you are unable to recognize the problem, have the NitroFire™ examined by a qualified gunsmith.

© 2020 Traditions™ Performance Firearms. All Rights Reserved.

11. FIRING YOUR NITROFIRE™

 **DANGER: ALWAYS POINT THE MUZZLE IN A SAFE DIRECTION AND BE SURE OF YOUR TARGET AND WHAT IS BEYOND IT.**

 **WARNING: BE SURE TO WEAR PROPER EYE AND EAR PROTECTION ANY TIME YOU FIRE YOUR NITROFIRE™. MAKE SURE ALL BYSTANDERS IN THE AREA ARE ALSO WEARING PROPER EYE AND EAR PROTECTION AT ALL TIMES.**

 **WARNING: NEVER SOLELY RELY ON THE MECHANICAL SAFETY OF YOUR NITROFIRE™ FOR YOUR SAFETY AND THE SAFETY OF OTHERS. IT SHOULD NOT REPLACE PROPER FIREARM HANDLING PROCEDURES DESCRIBED IN THIS MANUAL.**

Mechanical features such as safeties can fail and should never be relied upon with disregard to proper safe firearms handling. You should always maintain proper safety practices as outlined in this manual.

 **WARNING: NEVER FIRE THE NITROFIRE™ WITH ONLY A FIRESTICK™ AND NO PROJECTILE. THIS COULD RESULT IN PARTICLES EXITING THE BARREL.**

Now after following the previous loading instructions, your Nitrofire™ is charged, primed, and ready to fire.

1. Grasp the NitroFire™ firmly with both hands with your finger off the trigger and out of the trigger guard. Make sure the safety is on and the red ring is not visible. Raise the NitroFire™ up and firmly pull the stock into your shoulder.
2. Pull the hammer back slowly until it is in the full cock position. Your safety should remain in the "safe" position so the red ring is not visible. The NitroFire™ is now cocked and ready to fire. **Never carry the NitroFire™ in the cocked position. Do not disengage safety until you are ready to fire. If you decide not to fire, see pages 32 and 33.**
3. Acquire your target and aim with your sights or scope. Remember to be sure of what is beyond your target.

 **WARNING: DO NOT COCK THE NITROFIRE™ UNTIL YOU ARE READY TO FIRE.**

4. Disengage the manual trigger safety so the red ring is visible. Slowly squeeze the trigger until the NitroFire™ fires. Once the NitroFire™ fires place the trigger safety back on safe by pushing it from left to right so no red ring is visible.

12. REMOVING THE FIRESTICK™ AFTER FIRING

1. Confirm the manual trigger safety is engaged the red ring is not visible.
2. Press the barrel catch lever and open the action to expose the primer and Firestick™.
3. Using your finger, remove the spent Firestick™ and primer from the breech and dispose of it properly.



13. MISFIRES, HANGFIRES, & SQUIB LOADS

If, after following the previous instructions, the NitroFire™ did not fire then you have had a Misfire, Hangfire, or Squib load. Anyone involved with firearms may experience a misfire, hangfire, or Squib load at one time or another. The following are a few simple procedures that will help you to effectively manage such occurrences.

⚠️ WARNING: A MISFIRE, HANGFIRE, OR SQUIB LOAD IS A DANGEROUS SITUATION AND IT IS IMPERATIVE YOU PROCEED WITH EXTREME CAUTION. AS YOU ALWAYS SHOULD DO, BUT ESPECIALLY IN THIS SITUATION, BE SURE TO KEEP THE NITROFIRE™ POINTED IN A SAFE DIRECTION AS IT MAY FIRE AT ANY TIME.

A **MISFIRE** is a failure of the primer or Firestick™ to ignite. This could be a very hazardous situation.

⚠️ WARNING: Extreme caution should be exercised when dealing with a misfire or hangfire.

Rarely is a misfire the fault of the firearm. Generally, it can be attributed to a problem with Firestick™ or primer. Should your NitroFire™ fail to fire for any reason, **keep the NitroFire™ pointed at your down-range target for at least one minute with the action closed. By doing so, you make sure you are prepared for the chance of a delayed ignition.**

If your primer fails to fire, discard this primer and try a new one. If your primer is dented but the Firestick™ did not ignite discard the Firestick™ and dented primer according to range or hunting regulations. Start fresh with a new Firestick™ and primer.

A **HANGFIRE** is a delayed ignition. The primer fires when the trigger is pulled and the main charge fires a brief moment later. There are many reasons that hangfires occur. If you are experiencing hangfires, there are possible causes that you need to evaluate. Verify the following:

1. Verify the primer is the correct size and properly fitted onto the Firestick™.
2. Check the condition on the primers and Firesticks. For hunting situations, it is a wise practice to use fresh primers and Firesticks. Use a fresh load for each day's hunting.

A **SQUIB LOAD** is the result of a Firestick™ producing less than normal pressure or velocity after primer ignition. In some cases the bullet can become lodged in the bore, creating an obstruction. If you experience a reduction in noise, muzzle flash, or recoil STOP SHOOTING IMMEDIATELY. Keep the NitroFire™ pointed downrange and follow the unloading instructions to confirm there is no bullet or object in the barrel.

If you experience a **MISFIRE, HANGFIRE, OR SQUIB LOAD** keep the NitroFire™ pointed down range for one minute. The NitroFire™ could fire so be prepared for this. If the firearm does not fire after one minute, keep the NitroFire™ pointed downrange and carefully unload your firearm, making sure not to expose yourself to the breech area. Dispose of defective primers and Firesticks in accordance with your local, state, and federal laws and regulations.

14. DE-COCKING THE NITROFIRE™

⚠ WARNING: ALWAYS KEEP THE MUZZLE POINTED IN A SAFE DIRECTION AND BE SURE OF YOUR TARGET AND WHAT IS BEYOND IT.

NOTE: When the NitroFire™ is in the full cock position, the action is locked in battery and cannot be opened.

If your NitroFire™ is in the full cock position and you no longer want to fire the NitroFire™, carefully follow these steps to de-cock the firearm.

Unloading can be accomplished into the At Rest position. Once the hammer is in this position, engage the manual trigger safety.

Follow the directions below:

1. Both hands should be dry and not impeded in any way.
2. Disengage the manual trigger safety by pressing the button from right to left so the red ring is visible.



⚠ WARNING: THE FIREARM IS NO LONGER IN THE "SAFE" POSITION.

3. Carefully, while holding your thumb on the hammer in the cocked position, depress the trigger slowly until you feel the hammer release. Immediately release your finger from the trigger and slowly lower the hammer in a controlled manner into the At Rest position. Engage the manual trigger safety so the red ring is no longer visible. At this point you can safely open the action.



NOTE: Practice this with an unloaded firearm so you feel comfortable with the process of safely lowering the hammer.

⚠ WARNING: NEVER DRY FIRE YOUR NITROFIRE™.

15. UNLOADING THE NITROFIRE™ IF YOU DON'T FIRE

⚠ DANGER: ALWAYS POINT THE MUZZLE IN A SAFE DIRECTION AND DO NOT HAVE ANY PART OF YOUR BODY OVER THE MUZZLE WHEN UNLOADING.

NOTE: YOU MUST USE TRADITIONS™ NITROFIRE™ UNLOADING JAG TO UNLOAD YOUR NITROFIRE™.

1. Make sure the muzzle of the barrel is pointed in a safe direction at all times.

2. Open the action and carefully remove the Firestick™ with your fingers. Close the action.



3. Remove your ramrod from the thimbles. Unscrew the jag and flip it 180 degrees. Screw back onto the ramrod to elongate the rod.

4. Attach the NitroFire™ Unloading Jag to your ramrod.
NOTE: NitroFire™ Unloading Jag sold separately.

5. Insert the unloading jag into the breech area. Make sure the end of the unloading jag is against the back of the bullet and not the shelf. Push the bullet out of the barrel from breech to muzzle.



NOTE: Remove the unloading jag before putting the ramrod back into the thimbles.



CAUTION: DISCARD ANY BULLET REMOVED FROM THE BARREL. THE BULLET MAY HAVE BECOME DEFORMED OR THE SABOT MAY BECOME COMPROMISED WHEN UNLOADING.

6. Clean and wipe all surfaces to remove any fouling or debris.

16. CLEANING & MAINTENANCE **OF THE NITROFIRE™**

⚠ WARNING: ALWAYS POINT THE NITROFIRE™ IN A SAFE DIRECTION AND TREAT THE NITROFIRE™ AS IF IT WAS LOADED AND CAN FIRE.

⚠ WARNING: CONFIRM THE NITROFIRE™ IS UNLOADED BEFORE CONDUCTING ANY OF THE METHODS IN THIS SECTION.

⚠ WARNING: DO NOT DISASSEMBLE YOUR NITROFIRE™ ANY FURTHER THAN WHAT IS DESCRIBED IN THIS MANUAL.

Disassembling your NitroFire™ further could cause the firearm to become unsafe. As a result, it could cause serious injury and/or death to the shooter or bystanders and could damage the NitroFire™.

⚠ WARNING: CONFIRM NO FIRESTICKS, PRIMERS, OR PROJECTILES ARE PRESENT OR AVAILABLE DURING ANY DISASSEMBLY, REASSEMBLY, OR FUNCTION TEST PROCEDURES.

NOTE: Reference to the exploded view diagram in the manual will help identify part names and numbers.

RANGE/FIELD CLEANING AND ADVICE WHILE SHOOTING

A systematic routine of cleaning while shooting is strongly advised to aid in avoiding problems while loading and to optimize accuracy. There are two ways Traditions™ suggests effectively cleaning your NitroFire™ while shooting at the range.

Method 1

Make sure the NitroFire™ is uncharged and unloaded. The safety should be in the "safe" position so no red ring is visible and should always be pointed in a safe direction. With the action open, take a Traditions™ dry patch and saturate it in bore solvent (or you can use a pre-saturated cleaning patch.) Traditions™ suggests using a Traditions™ Range Rod but you can also use the ramrod that comes with the NitroFire™ with the jag flipped around to elongate the rod. Place the patch over the end of your rod and insert it into the muzzle end of the NitroFire™. Run the patch up and down to remove any fouling. You'll feel your ramrod stop at the shelf. Do not push past the shelf. Remove the saturated patch and discard. Place a dry patch over the end of the rod and run the dry patch from the muzzle to the shelf to remove any moisture. Do this until the patch is clean. Repeat this process as many times as necessary until your barrel is clean. The same process should be repeated going from the breech. You should not push past the shelf. The chamber area may need additional cleaning with the Nylon Chamber brush. Insert the brush into the chamber and remove it. You may feel resistance. Repeat as necessary to remove fouling. You must be sure both sides of the shelf area are thoroughly cleaned so the Firestick™ is always fully seated.

Method 2

Make sure the NitroFire™ is uncharged and unloaded. The safety should be in the "safe" position so no red ring is visible and should always be pointed in a safe direction. With the action open, use a Traditions™ Range Rod (recommended) or the ramrod that came with the NitroFire™ with the jag removed, screw in the NitroFire™ Bronze Bore Brush. Spray or saturate the bronze brush with bore solvent such as Traditions™ BlackOut 209. Going from the breech to the muzzle, run the bronze brush back and forth through the barrel. You will be able to go past the shelf with this process. The bronze brush will help break up fouling. Remove the bronze brush (and if using the ramrod that came with the NitroFire™ replace the jag so it is in the elongated position) and place a dry patch over the end of the rod. Run the dry patch from the muzzle to the shelf to remove any moisture. Do this until the patch is clean. Repeat this process as many times as necessary until your barrel is clean. The same process should be repeated going from the breech. You should not push past the shelf. The chamber area may need additional cleaning with the Nylon Chamber brush. Insert the brush into the chamber and remove it. You may feel resistance. Repeat as necessary to remove fouling. You must be sure both sides of the shelf area are thoroughly cleaned so the Firestick™ is always fully seated.

ADDITIONAL RANGE CLEANING ADVICE

1. Do not use shooting patches when cleaning your NitroFire™. They are too small. You should use Traditions™ cleaning patches.
2. If a patch gets stuck, remove the patch by pushing it out with your ramrod from the chamber or bore until it is out of the barrel. Never load a charge over a lost patch.
3. If unusual resistance is felt while loading your projectile, perform Method 1 or Method 2 to remove as much of the fouling build up as possible.

NOTE: It should never be necessary to hammer or excessively force a projectile down the bore. Projectiles should load firmly with pressure from the ramrod down the barrel. If the projectile is the proper size, unusual resistance usually indicates a need to clean the bore. Use Method 1 or Method 2 to help remove fouling. If you are utilizing Method 1 with the saturated patch, it may be necessary to perform Method 2 with the bronze brush to remove excessive fouling.

4. When sighting in, it is important to develop a habit of consistently wiping the bore after each shot. This is beneficial when sighting in for hunting so that your accuracy will be based on a clean bore. Depending upon the specific load, temperature, and humidity, a short series of shots can be fired before it becomes necessary to clean the bore and breech area using Method 1 or Method 2.

NOTE: A fouled barrel will directly affect your ability to group shots. However, in a hunting situation, only a few shots will likely be taken. If the barrel is prepped and lubed at the onset, it is not necessary to clean and lube the interior of the barrel between shots when hunting.

17. DISASSEMBLY, DETAILED CLEANING, & REASSEMBLY

⚠ WARNING: ALWAYS POINT THE NITROFIRE™ IN A SAFE DIRECTION AND TREAT THE NITROFIRE™ AS IF IT WAS LOADED AND CAN FIRE.

⚠ WARNING: CONFIRM THE NITROFIRE™ IS UNLOADED BEFORE CONDUCTING ANY OF THE METHODS IN THIS SECTION.

⚠ WARNING: DO NOT DISASSEMBLE YOUR NITROFIRE™ ANY FURTHER THAN WHAT IS DESCRIBED IN THIS MANUAL.

Disassembling your NitroFire™ further could cause the firearm to become unsafe. As a result, it could cause serious injury and/or death to the shooter or bystanders and could damage the NitroFire™.

Required Tools & Supplies

- Dry Patches
- 4mm Allen Wrench
- Traditions™ Range Rod or Ramrod with Jag
- Pipe Cleaners
- Safety Glasses
- Cleaning Jag
- BlackOut 209 Solvent
- Seasoning Patches or Wonderlube
- NitroFire™ Bronze Brush
- Nitrofire™ Nylon Brush

The disassembly procedure is most often used for general cleaning, lubrication, and inspection of your Traditions™ NitroFire™. Traditions™ recommends this be completed after each shooting session. By following this procedure it will help keep your NitroFire™ shooting safely and reliably for years to come.

DISASSEMBLY

1. **Follow all safety rules listed previously in this manual. Be sure the safety is engaged so it is in the "safe" position and the red ring is not visible.**
2. Open the NitroFire™ by depressing the barrel catch lever. Inspect the barrel to be sure your NitroFire™ is unprimed, unloaded, and free of obstruction. Once you've determined the NitroFire™ is safe you can close the action.
3. Remove the ramrod from the NitroFire™.



4. Remove the forend stock screw from the barrel assembly using the 4mm Allen wrench.



5. Remove the barrel from the frame by pushing the barrel catch lever in.

6. When the barrel starts to open, lift the barrel out of the frame. You can now clean your barrel and frame. Field disassembly is now complete.



DETAILED CLEANING

 WARNING: WEAR SAFETY GLASSES WHILE CLEANING TO PROTECT EYES FROM FLYING SPRINGS OR SOLVENTS.

The Traditions™ NitroFire™ is designed to reduce internal fouling of the frame and its' components. Detailed cleaning, lubrication, and inspection of the entire NitroFire™ system should be performed after you are done shooting for the day and before storing for an extended period of time. Performing this detailed cleaning will help keep your NitroFire in its' best operating condition.

After following the disassembly instructions, your NitroFire™ should be disassembled.

1. **Follow all safety rules listed previously in this manual. Be sure the safety is engaged so it is in the "safe" position and the red ring is not visible.**

2. Using Traditions™ Range Rod or your ramrod, attach the NitroFire™ Bronze Bore Brush to your ramrod.

Note: You can use either the NitroFire™ Nylon Bore Brush or the NitroFire™ Bronze Bore Brush. We recommend the Bronze Brush because it is excellent at hard scrubbing and removing fouling.

3. Spray a bore solvent, such as Traditions™ BlackOut 209 solvent, on your bore brush. Note: Traditions™ Foaming Bore Solvent can also be used instead of spraying the bore solvent on the bronze brush. Allow solvent to sit for 15 minutes inside the barrel. This will allow time for the solvent to engage and penetrate the fouling. Do not let it dry.

4. To clean your barrel, insert your bronze brush into the breech area. Push the ramrod from the breech to the muzzle until the brush exits the muzzle. Pull the ramrod back through the barrel towards the breech. The technique allows you to go past the shelf in the barrel and helps to break up fouling.



5. Remove the bronze brush from the ramrod and attach the cleaning jag.

6. Place a dry cotton patch over the jag and insert it into the muzzle. Run the ramrod with the patch from the muzzle to the shelf in the barrel to help remove fouling. Pull the ramrod back through to the muzzle. Repeat until patch comes out clean.



⚠ WARNING: Do not push past the barrel shelf.

7. To clean the chamber area, spray the NitroFire™ Nylon Bore Brush with the bore solvent and insert it into the chamber up to the back of the shelf. Pull the brush back out of the chamber. You may feel some resistance. Repeat this process until the chamber area and back of the shelf is clean.



8. Place a dry cotton patch over the cleaning jag and insert it into the chamber. Carefully push the ramrod with the patch from the breech opening to the barrel shelf. Repeat until patch comes out clean.



⚠ WARNING: Do not push past the barrel shelf.

9. Using a Traditions™ Cleaning & Seasoning Patch or some gun lube on a dry patch, place the patch over the cleaning jag and insert into the muzzle. Push the patch from the muzzle to the barrel shelf. This will help protect against rust and allow for easier loading. Note: As an alternative, you could use the NitroFire™ Cotton Bore Swab saturated with solvent.

 **WARNING: Do not push past the barrel shelf.**



10. Repeat step 9 going from the chamber. Push the patch from the breech opening to the barrel shelf. This will help protect against rust and allow for easier loading. Note: As an alternative, you could use the NitroFire™ Cotton Bore Swab saturated with solvent.

 **WARNING: Do not push past the barrel shelf.**



11. Lightly spray the barrel lug and extractor with Traditions™ Cleaning Solvent. Wipe the solvent off with a dry cotton cleaning patch. If these areas are heavily fouled use the NitroFire™ Nylon Brush to remove fouling from the barrel catch and pivot points. The extractor should move freely. Note: If it is not moving freely, soak your barrel in solvent or hot, soapy water. Allow the barrel to sit and periodically check to see if the extractor has loosened.



12. Apply a light coating of gun oil to the outside of the barrel and all metal surfaces including the extractor. Tip: Push the extractor towards the muzzle. Apply oil into the space and release the extractor. This will allow oil to run down through the area.



13. To clean the inside of the frame, lightly spray cleaning solvent on the inside of the frame. Use the NitroFire™ Nylon Brush or a dry patch to remove fouling. Be sure the fouling is removed from the frame face and the barrel catch. Use a dry patch to remove any residual moisture.



14. Pull the trigger and push the hammer forward so the firing pin is exposed. Use a dry patch that has been sprayed with solvent to clean the exposed portion of the firing pin. After the firing pin has been cleaned, release the trigger and remove your thumb from the hammer. The hammer should move into the At Rest position and the firing pin should recess back into the frame.



15. To clean the outside of the frame, lightly spray it with solvent. Use the NitroFire™ Nylon Brush to remove any fouling from the outside of the frame, the barrel release lever, hammer, hammer extension, and inside the hammer channel.



16. Oil the inside and outside of the frame. Be sure to oil all metal surfaces.



17. Lightly grease the pivot points on the frame.

You have completed the detailed cleaning of your NitroFire™. You can now reassemble your NitroFire™.

REASSEMBLY

1. Press the barrel catch lever in and reinstall the barrel assembly onto the frame and lock into place.



2. Reinstall the forend onto the barreled action.



3. Install the forend screw back into the forend using the 4mm Allen wrench.

⚠ WARNING: DO NOT OVERTIGHTEN. THIS COULD CAUSE DAMAGE TO YOUR NITROFIRE™.



4. Reinstall your ramrod.

Reassembly of the NitroFire™ is now complete.

⚠ WARNING: DO NOT FIRE YOUR NITROFIRE™ WITH EXCESS GREASE, OIL, OR OTHER MATERIAL IN THE BORE. These lubricants or solvents can partially or fully obstruct the bore which could result in damage to the firearm or injury to the shooter and/or bystanders.

NOTE: Store your NitroFire™ uncharged and unprimed in a cool, dry, secured area. Storage in a gun case should be avoided as it may hasten condensation and corrosion. During long periods of storage, periodically check for signs of pitting or rusting on the surface and in the barrel.

18. SCOPE MOUNTING & SIGHTING IN

The Traditions™ NitroFire™ comes drilled and tapped for easy installation of mounts and a scope and may come with a scope already mounted depending on the model.

 WARNING: DO NOT DRILL EXTRA HOLES IN YOUR BARREL. This can cause weakening of the barrel and the possibility of the barrel rupturing and/or bursting, resulting in injury or death to you or others.

Traditions™ recommends using Traditions™ scope bases and rings for mounting your scope as they are designed for your firearm. If you need to purchase new mounts and rings you can do so at your local dealer or on www.traditionsfirearms.com. Please contact Traditions™ Customer Service Department with any questions about proper mounts and rings for your firearm.

Securing Scope Bases to Your Barrel

Use the Allen wrench provided with your NitroFire™ to secure scope bases to your firearm. You should also use the Allen wrench for tightening the screws on the scope rings which should be finger-tight. Overtightening the screws can cause stripped threads and/or bent and distorted mounts. Using Loctite® and other threading compounds is encouraged but not a requirement.

Mounting Your Scope

Traditions™ offers a wide variety of scopes and mounting options to suit many needs. Visit www.traditionsfirearms.com to see our full line of optics and mounts or a dealer near you.

When mounting your scope, please take precaution in ensuring that your front objective lens bell is not touching the firearm and that your eyepiece has clearance from your hammer or cocking mechanism.

 WARNING: MAKE SURE THAT YOUR EYE RELIEF IS SUCH THAT YOU HAVE A COMFORTABLE AIMING POSITION BUT THAT YOU HAVE AN APPROPRIATE DISTANCE FROM YOUR EYE SO THAT YOU ARE NOT STRUCK BY THE SCOPE UNDER RECOIL WHILE SHOOTING.

Rifle Scope Adjustment

Rifle scopes have two turrets of adjustment for adjusting the point-of-aim for the shooter. Adjustment for elevation is on the top of the scope and windage is typically found on the right-hand side of the scope when mounted on the NitroFire™.

 WARNING: ALWAYS FOLLOW SCOPE MANUFACTURER'S MOUNTING INFORMATION AND DIRECTIONS.

Bore Sighting A Break Action Firearm

1. Check to ensure the barrel is unloaded and has no obstructions.
2. Remove your barrel from the firearm and carefully place it with the mounted scope on a sandbag or shooting vise.
3. Looking down the bore from the breech side, move your barrel to where the center of your target is in the middle of the field of vision.
NOTE: You can use a bore sighter for this process as well.

Sighting-In Your Firearm

1. Once bore-sighted, install your barrel back on your firearm. Place the firearm on your sandbag or shooting vise and fire a minimum of two shots at the bullseye.
2. Without moving the firearm, observe your shot group and its relation to the bullseye (or point of aim.)
3. Carefully adjust your scope's crosshairs with the turrets to the center of the shot group. Most hunting scopes adjust 1/4 inch per click at 100 yards. 50 yards is 1/8" and 200 yards is 1/2" per click.
4. Once your scope is adjusted to the point of impact, carefully move your firearm back to the bullseye as the point of aim.
5. Fire another shot group to determine if the point of impact is in alignment with your aim.
6. If you wish to zero at a greater distance, consult ballistic data for the load you are firing and repeat this process at that given distance.

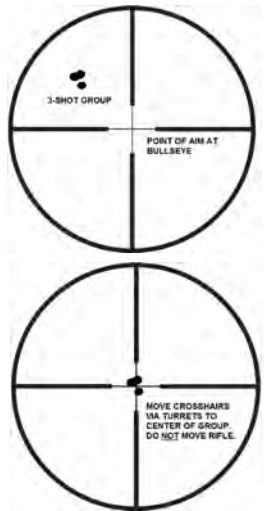

19. INFORMATION ON PROJECTILES, FIRESTICKS, & PRIMERS

⚠ WARNING: ALWAYS FOLLOW THE RECOMMENDED LOAD INFORMATION PROVIDED IN THIS BOOK OR BY THE FIRESTICK™ MANUFACTURER. FAILURE TO DO SO COULD CAUSE INJURY AND/OR DEATH TO THE SHOOTER AND BYSTANDERS AND DAMAGE TO PROPERTY.

PROJECTILES

⚠ WARNING: DO NOT LOAD OR FIRE ANY PROJECTILES THAT ARE NOT APPROVED BY TRADITIONS FIREARMS DUE TO EXCESSIVE PRESSURES. INJURY AND/OR DEATH TO THE SHOOTER OR BYSTANDERS AND DAMAGE TO PROPERTY MAY OCCUR. VISIT WWW.TRADITIONSFIREARMS.COM.

⚠ WARNING: DO NOT USE PATCHED ROUND BALLS, CONICALS, OR MINIE BALLS.

⚠ WARNING: BE SURE ONLY ONE PROJECTILE IS LOADED IN THE BARREL. DO NOT LOAD A PROJECTILE ON TOP OF ANOTHER. INJURY AND/OR DEATH TO THE SHOOTER OR BYSTANDERS AND DAMAGE TO PROPERTY MAY OCCUR.

There are many projectiles in the marketplace which would be appropriate for use in the NitroFire™. Be sure it is a bullet that is specific for muzzleloaders or has been rated for muzzleloader use. Bullets are ever changing and there may be new bullets on the market that are not on our suggested list. Please visit www.traditionsfirearms.com for full ballistic information or contact our customer service department with any questions regarding which projectiles are best used in your NitroFire™.

SUGGESTED LOADS FOR THE NITROFIRE™

Description	Bullet Weight	Caliber	Bullet Dia.	Firestick Charge	Velocity (Ft/Sec) Yards					
					Muzzle	50	100	150	200	250
Traditions™ Smackdown® Bleed™	170gr	.50 cal	.45	100gr Eq	2217	2019	1832	1658	1498	1355
Traditions™ Smackdown® XR™	200gr	.50 cal	.45	100gr Eq	2157	1958	1772	1599	1442	1303
Traditions™ Smackdown® XR™	250gr	.50 cal	.45	100gr Eq	2038	1893	1756	1626	1505	1393
Traditions™ Smackdown® Carnivore™	250gr	.50 cal	.45	100gr Eq	2038	1893	1756	1626	1505	1393
Federal Premium® B.O.R Lock Copper	270 gr	.50 cal	.45	100gr Eq	2018	1792	1584	1400	1245	n/a
Traditions™ Smackdown® Carnivore™	275gr	.50 cal	.45	100gr Eq	1977	1848	1725	1609	1500	1399
Traditions™ Smackdown® Carnivore™	305gr	.50 cal	.45	100gr Eq	1899	1804	1712	1624	1541	1461
Traditions™ Smackdown® Carnivore™	250gr	.50 cal	.45	120gr Eq	2154	2004	1862	1726	1598	1479
Traditions™ Smackdown® Carnivore™	305gr	.50 cal	.45	120gr Eq	2033	1933	1837	1744	1655	1570
Federal Premium® B.O.R Lock Copper	270gr	.50 cal		120gr Eq	2051	1870	1700	1543	1400	n/a

*Eq. = Equivalent

FEDERAL PREMIUM® FIRESTICK™

 **WARNING: BE SURE TO READ AND FOLLOW ALL WARNINGS FROM THE FIRESTICK™ MANUFACTURER FOUND ON THEIR PACKAGING AND WEBSITE.**

 **WARNING: NEVER RELOAD ANY NEW OR FIRED FIRESTICKS. ONLY USE NEW, FACTORY-LOADED FIRESTICKS IN THE NITROFIRE™.**

 **WARNING: DO NOT LOAD OR USE ANY DEFORMED FIRESTICK™.**

 **WARNING: NEVER USE LOOSE OR PELLETIZED POWDER IN THE NITROFIRE™. YOU CAN ONLY USE THE FIRESTICK™.**

 **WARNING: DO NOT LOAD POWDER ON TOP OF THE FIRESTICK™.**

The Federal Premium® Firestick™ is an encapsulated powder charge. It is factory-loaded so it will have the same tight tolerances as factory-loaded ammunition. This provides the shooter increased consistency since they are using the exact same load each time. This system also provides increased accuracy due to the bullet being seated in the same spot each time and the Firestick™ providing the same charge each time.

The Firestick™ is single use and should never be reloaded. It is available in different grain weight options. Be sure to read all packaging provided by the manufacturer for warnings and information on the Firestick™.

PRIMERS

Traditions™ recommends using the Federal® 209 muzzleloading primer with the NitroFire™ and Firestick™ system.

20. WARRANTY & SERVICE

LIMITED LIFETIME MECHANICAL WARRANTY

Traditions™ will warrant this firearm to be free of mechanical defects in materials or craftsmanship for the life of the firearm while in the possession of the original owner except composite stocks, wood stocks, and finishes. Traditions™ will repair or replace, at its own option, product or parts which are returned at owner's expense to the Traditions™ Customer Service Department. Call 860-388-4656 to obtain a factory issued Return Merchandise Authorization number. A full explanation of the specific problem must be given to the customer service representative.

This warranty shall remain in force unless any of the following are determined by the Traditions™ Customer Service Department:

1. Normal wear from regular and intended use.
2. Failure to comply with the instructions listed here in the owner's manual.
3. Modification of internal parts as they were shipped from the factory.
4. A lack of proper maintenance and thorough cleaning is evident such as rust.
5. Malfunctions and damage caused by the use of reloaded Firesticks, extra propellant, incorrect propellants, bullets, or primers.
6. Malfunctions and damage caused by the use of any charge in excess of those recommended in this booklet or by the Firestick™ manufacturer.
7. Customer abuse.

Traditions™ specifically disclaims any and all warranties other than those listed above on this page to the fullest extent allowed under applicable law, including warranties of merchantability and/or fitness for a particular purpose. This warranty applies only to the firearm. It does not apply to any accessories.

NOTE: Proof of purchase is required to show original ownership for all warranty work.

PLEASE HELP US SERVE YOU BETTER

In the event you should have questions pertaining to the function or performance of your new Traditions™ firearm please visit our website to get answers to the most commonly asked questions. Log on to www.traditionsfirearms.com where you will find the FAQ page. This page will get you fast access to trouble shooting solutions. If you do not find an answer to your specific question on the FAQ page of our website please feel free to email info@traditionsfirearms.com and a qualified member of our team will respond to your individual question as quickly as possible. Additionally, there are numerous videos on our website that can help answer questions regarding your firearm. Visit www.traditionsfirearms.com/video-listings or <https://www.youtube.com/user/TraditionsFirearm>.

In the event you still need assistance please do not hesitate to contact Traditions™ and a member of our Customer Service Department will be happy to assist.

In the unlikely event you need warranty service on your firearm we need your help to get the work done right and without delay. It is simple to send an email or give us a call to discuss the issue.

Traditions™ conveniently engraves the caliber, serial number and model name on each firearm. Take note of this information, record it on the warranty page in this manual and be prepared to state it when contacting the Traditions™ Customer Service Department with your questions.

Steps to Return a Firearm for Service

1. Do not return your firearm to the dealer.
2. Please call us and describe the problem. Chances are we can either guide you to a solution right over the phone or when possible send you the parts you need to correct the problem. Should your firearm need factory service, we will give you instructions about where to ship it and issue you a Return Merchandise Authorization number.
3. All firearms must have a factory issued Return Merchandise Authorization number (RMA) before returning to Traditions™ for warranty service. Firearms without an RMA number will be refused.

4. Package your unloaded firearm safely and securely inside a sturdy box. The Traditions™ box your firearm arrived in is **NOT** a shipping box. **NOTE: Firearms packaged and shipped improperly are not covered under warranty if damage occurs.**
5. Write your RMA # on the outside of the box so it can be easily seen when it arrives at our facility.
6. Ship your unloaded firearm to:
Traditions™
1375 Boston Post Rd. • P.O. Box 776
Old Saybrook, CT 06475-0776

 **WARNING: It is in violation of Federal Law to ship a loaded firearm. If your firearm has a live charge and/or projectile in the barrel, please take it to a local gunsmith for removal or call Traditions™ Customer Service Department at 860-388-4656.**

 **ATTENTION: YOUR FIREARM MUST BE CLEANED BEFORE IT CAN BE INSPECTED.** If we need to clean your firearm in order to inspect it there will be a standard cleaning, lubrication, inspection, and function test (C.L.I.F.) service fee.

NOTE ON ACCESSORIES:

Please remove all after-market accessories from your firearm prior to sending in for repairs. This will ensure that these items will not be lost, misplaced, or damaged during the return process.

TRADITIONS™ WILL NOT BE HELD LIABLE FOR ANY AFTER-MARKET ITEMS OR ACCESSORIES THAT ARE LOST OR DAMAGED IF THEY ARE NOT REMOVED AND ARE SENT IN ON YOUR TRADITIONS™ ITEM COMING BACK FOR REPAIR.

Patents Pending

© 2020 Traditions™ Performance Firearms. All Rights Reserved.

FOR YOUR RECORDS

Important: Please record information here and keep for your record.

Model No. _____

Serial No. _____

Model Name _____

Caliber _____

Date Purchased _____

From _____

Registration Card mailed on _____

Please call Traditions™ Customer Service Department at 860-388-4656 with any questions or concerns.

To register your warranty online please go to www.traditionsfirearms.com/support/warranty-registration, or you can mail in the warranty card on the opposing page.

To be added to our email list for announcements, specials, and other information please visit our website at: www.traditionsfirearms.com

07/20 AKH

© 2020 Traditions™ Performance Firearms. All Rights Reserved.



Quick-T™ Ramrod Handle Owner's Manual Addendum

Your new Quick-T™ Ramrod Handle is designed to provide easy and quick loading of your Traditions™ muzzleloader. This handle is designed to be stored on your ramrod for easy access. The Quick-T™ Ramrod Handle incorporates a palm saver and a jag to thread into the handle so it functions as a work/cleaning rod.

How to use your Quick-T ramrod handle:

- **Your Quick-T™ Ramrod Handle will come installed on the ramrod of your new rifle. Simply remove your rifle's ramrod to remove the Quick-T™ Ramrod Handle.**
- **The Quick-T™ Ramrod Handle can be used in two ways.**

1) When being used as a palm saver:

Using only the plastic "T" piece of the Quick-T™ Ramrod Handle, place the T-handle over the end of the threaded side of your ramrod. This is a quick and easy way to push your projectile down the barrel and protect your hand from the end of the ramrod.

2) When being used as a work/cleaning rod:

Screw the brass jag into the threaded pocket of your Quick-T™ Ramrod Handle. This allows the Quick-T™ Ramrod Handle to thread directly onto the 10/32 threads on your ramrod, providing a fully functional cleaning rod for maintaining your rifle in the field or at the range. If you over-tighten the jag into the Quick-T™ Ramrod handle, the hole in the screw-in brass jag will assist you in removal or tightening. Use a small Allen key through hole if needed.

CAUTION: Always follow the manufacturer's loading and shooting instructions. Be sure to read the owner's manual prior to using your rifle. Be sure the Quick-T™ Ramrod Handle does not extend past the end of the muzzle when firing your rifle. Never fire your rifle with the Quick-T™ Ramrod Handle threaded on your ramrod installed in the barrel thimbles.

PREFERRED CUSTOMER WARRANTY REGISTRATION CARD



Referencing the label on the end of the carton, please write in the last 5 digits located on the right half of the UPC code into the boxes below.

UPC #

4	0	5	8	9	-					
---	---	---	---	---	---	--	--	--	--	--

Model# _____

Serial# (from barrel) _____

Name _____ Age _____

Street _____

City _____ State _____ Zip _____

Day Time Phone # _____ Date of Purchase _____

Purchase Price _____ Store Name _____

1. **What is your age?** Under 18 18-24 25-34 35-44 45-54 55-64 over 65
2. **Reason for your purchase** Hunting Target Shooting Personal use Gift
 Raffle Prize Other
3. **Do you own?** Muzzleloaders Over/Under Shotgun Side by Side Shotgun
 Semi-Auto Shotgun Pump Shotgun Cartridge Rifle Handgun Bow
4. **Where purchased?** Gun Shop General Sporting Goods Store Hardware Store
 Chain Store Mail Order Catalog Internet Store
5. **Which factors influenced your purchase?** Previously owned a *Traditions* product
 Magazine Ad/Article Website *Traditions* Catalog Recommendation of Salesperson
Recommendation of a Friend Price Features Other
6. **What type of game do you hunt?** Whitetail Deer Mule Deer Elk Bear
 Antelope Turkey Small Game Other
7. **What do you think is the best way to get information about Hunting & Hunting products?**
Magazine Ads Internet/Website Television Programs Radio
8. **Which magazine/s do you read?** _____
9. **Which TV hunting shows do you watch?** _____

To be added to our email list to receive Traditions™ emails including giveaways, product information, and more please provide your email address:

NOTE: Return this card within 15 days of purchase in order to validate your warranty.

Please complete all information above and mail to:



P.O. Box 776 • Old Saybrook, CT 06475-0776

www.traditionsfirearms.com

© 2020 Traditions™ Performance Firearms. All Rights Reserved.

Cut Along Dotted Line



P.O. Box 776
Old Saybrook, CT 06475-0776

**Place
Postage Here.**
Or for additional
security enclose
in a envelope.