



Iver Johnson Arms, Inc.

Manual for 1911 style Pistols & Carbines



Warning: Do not use any type of +P ammunition (except for 38super models) or any type of reloaded ammunition with Iver Johnson 1911 pistols and carbines. Doing so will void the warranty.

IMPORTANT: BEFORE USING THIS FIREARM, COMPLETELY READ AND FOLLOW THE INSTRUCTIONS ENCLOSED IN THIS MANUAL.

NOTICE

This firearm should not be sold, transferred, or given to anyone prohibited by law to possess a firearm. For this information contact your local Bureau of Alcohol, Tobacco, Firearms and Explosives (BATFE) and your local law enforcement agency.

IMPORTANT

If you have purchased a 1911 model Thrasher pistol, there is a separate set of disassembly / reassembly instructions in this manual. See the glossary on the next page for details.

Warning! Must Read!

The stock for this 1911A1 Carbine cannot be used without a 16 inch or longer barrel, which is enclosed with this rifle. The use of any barrel shorter than 16 inches with this stock is illegal and goes against NFA regulations.



Warning: Do not touch the barrel when firing. It gets extremely hot and can cause severe burns.

All aspects of this carbine, other than the stock and the barrel, are the same as a standard 1911 pistol. Read and follow all instructions of the enclosed 1911A1 manual. This 16" barrel is removed from the slide the same as a standard 1911A1 barrel.

GLOSSARY

(If you do not have the model Thrasher, read the entire manual except for pages 42-48)

(If you do have the model Thrasher, read the entire manual except for pages 35-41)

State by State Warnings -	pg. 7
Safety Warnings -	pg. 13
External Parts -	pg. 23
Basic Parts Description -	pg. 25
Operation of Pistol -	pg. 28
Disassembly & Reassembly -	pg. 35
Thrasher Disassembly -	pg. 42
Thrasher Reassembly -	pg. 47
1911 Parts Illustration -	pg. 51
Thrasher Parts Illustration -	pg. 53
Warranty Information -	pg. 55

1911 Style Models

Model	Cal.	Barrel	Sights	Weight
Thrasher	45acp 9mm	3"	Fixed rear	34oz
Falcon	45acp	4.25"	GI style	38oz
Hawk	45acp 9mm	4.25"	Fixed rear Dovetail front	38oz
1911A1	45acp 9mm	5"	GI style	42oz
Eagle	45acp 9mm	5"	Adjustable rear Dovetail front	42oz
Eagle LR	45acp	5"	Adjustable rear Dovetail front	44oz
Eagle XL	45acp 10mm	6"	Adjustable rear Dovetail front	46oz
1911A1 Carbine	45acp	16.125"	GI style	64oz

For the safety of yourself and others, read this owner's manual in its entirety before handling your firearm. If there is any part of this manual that you do not understand, seek professional instruction from a licensed gun dealer.

****Other models and calibers may be added. Visit our website for specs and details****

Always keep this manual with this firearm. If you give or sell this firearm to another person, make sure this manual goes with the firearm, along with the lock enclosed with your pistol.

All Iver Johnson firearms come with a gun lock when shipped from the factory. Make sure to use this lock any time the firearm is not in use. Instructions on how to use the lock correctly are enclosed with the lock.

Never use +P ammunition, unless firing a 38super pistol, or any type of reloaded ammunition with this firearm. The use of reloaded, high pressure, or hand-loaded ammunition could cause bodily injury or death, and will void the warranty.

LEAD WARNING: The actual firearm does not contain lead, but it does fire ammunition which contains lead or lead compounds known to the State of California to cause cancer, birth defects, reproductive toxicity, and other serious physical injuries. Those who discharge a firearm, stand near someone who discharges a firearm, or clean firearms are hereby warned of the dangers presented by lead and lead compounds and should take protective health measures. Avoid exposure to lead while handling and wash your hands after contact. Proper air ventilation is absolutely necessary when shooting indoors.

Attention

Iver Johnson will not be responsible for injury, death, or damage to property which is due to intentional or accidental discharge of this firearm. Iver Johnson will not honor claims which result from careless or improper handling, replacement of parts or unapproved adjustments, corrosion, neglect, or use of incorrect ammunition caliber, or use of reloads with this firearm. Iver Johnson will not honor claims made by any owner other than the original owner of this firearm. Federal, and many state, regulations have laws covering storage of firearms and safety measures for keeping them away from children. Check the laws in your state.

Before this firearm left the factory, it was tested and inspected. Iver Johnson cannot control what happens to this firearm after it leaves the factory. Please examine this firearm carefully when purchased to ensure it is unloaded and undamaged.

This manual should always go with this firearm. If this firearm is sold or given away, this manual should accompany it.

State-By-State Warnings

Certain states require by law that their own specified warning notices in larger-than-normal type be conspicuously included by the manufacturer, distributor, or retail dealer with firearms sold in that state. Iver Johnson Arms, Inc. sells its products in compliance with applicable laws and regulations. Because our products may be sold in these states, we include the following:

California:

WARNING – “Children are attracted to and can operate firearms that can cause severe injuries or death. Prevent child access by always keeping guns locked away and unloaded when not in use. If you keep a loaded firearm where a child obtains and improperly uses it, you may be fined or sent to prison.”

ADVERTENCIA – “A los niños los atraen las armas de fuego y las pueden hacer funcionar. Ellos pueden causarse lesiones graves y la muerte. Evite que los niños tengan acceso a las armas de fuego guardándolas siempre con llave y descargadas cuando no las esté utilizando. Si usted tiene un arma de fuego cargada en un lugar en que un niño tiene acceso a ella y la usa indebidamente, le pueden dar una multa o enviarlo a la cárcel.”

State-By-State Warnings

Connecticut:

“UNLAWFUL STORAGE OF A LOADED FIREARM MAY RESULT IN IMPRISONMENT OR FINE.”

Florida:

“IT IS UNLAWFUL, AND PUNISHABLE BY IMPRISONMENT AND FINE, FOR ANY ADULT TO STORE OR LEAVE A FIREARM IN ANY PLACE WITHIN THE REACH OR EASY ACCESS OF A MINOR UNDER 18 YEARS OF AGE OR TO KNOWINGLY SELL OR OTHERWISE TRANSFER OWNERSHIP OR POSSESSION OF A FIREARM TO A MINOR OR A PERSON OF UNSOUND MIND.”

Maine:

“ENDANGERING THE WELFARE OF A CHILD IS A CRIME. IF YOU LEAVE A FIREARM AND AMMUNITION WITHIN EASY ACCESS OF A CHILD, YOU MAY BE SUBJECT TO FINE, IMPRISONMENT, OR BOTH. KEEP FIREARMS AND AMMUNITION SEPARATE. KEEP FIREARMS AND AMMUNITION LOCKED UP. USE TRIGGER LOCKS.”

State-By-State Warnings

Maryland:

“WARNING: Children can operate firearms which may cause death or serious injury. It is a crime to store or leave a loaded firearm in any location where an individual knew or should have known that an unsupervised minor would gain access to the firearm. Store your firearm responsibly!”

Massachusetts:

“WARNING FROM THE MASSACHUSETTS ATTORNEY GENERAL: This handgun is not equipped with a device that fully blocks use by unauthorized users. More than 200,000 firearms like this one are stolen from their owners every year in the United States. In addition, there are more than a thousand suicides each year by younger children and teenagers who get access to firearms. Hundreds more die from accidental discharge. It is likely that many more children sustain serious wounds, or inflict such wounds accidentally on others. In order to limit the chance of such misuse, it is imperative that you keep this weapon locked in a secure place and take other steps necessary to limit the possibility of theft or accident. Failure

State-By-State Warnings

Massachusetts (continued):

to take reasonable preventative steps may result in innocent lives being lost, and in some circumstances may result in your liability for these deaths.”

“IT IS UNLAWFUL TO STORE OR KEEP A FIREARM, RIFLE, SHOTGUN, OR MACHINE GUN IN ANY PLACE UNLESS THAT WEAPON IS EQUIPPED WITH A TAMPER-RESISTANT SAFETY DEVICE OR IS STORED OR KEPT IN A SECURELY LOCKED CONTAINER.”

New Jersey:

“IT IS A CRIMINAL OFFENSE TO LEAVE A LOADED FIREARM WITHIN EASY ACCESS OF A MINOR.”

State-By-State Warnings

New York City:

“THE USE OF A LOCKING DEVICE OR SAFETY LOCK IS ONLY ONE ASPECT OF RESPONSIBLE FIREARMS STORAGE. FOR INCREASED SAFETY, FIREARMS SHOULD BE STORED UNLOADED AND LOCKED IN A LOCATION THAT IS BOTH SEPARATE FROM THEIR AMMUNITION AND INACCESSIBLE TO CHILDREN AND OTHER UNAUTHORIZED PERSONS.”

North Carolina:

“IT IS UNLAWFUL TO STORE OR LEAVE A FIREARM THAT CAN BE DISCHARGED IN A MANNER THAT A REASONABLE PERSON SHOULD KNOW IS ACCESSIBLE TO A MINOR.”

Texas:

“IT IS UNLAWFUL TO STORE, TRANSPORT, OR ABANDON AN UNSECURED FIREARM IN A PLACE WHERE CHILDREN ARE LIKELY TO BE AND CAN OBTAIN ACCESS TO THE FIREARM.”

State-By-State Warnings

Wisconsin:

“IF YOU LEAVE A LOADED FIREARM WITHIN THE REACH OR EASY ACCESS OF A CHILD YOU MAY BE FINED OR IMPRISONED OR BOTH IF THE CHILD IMPROPERLY DISCHARGES, POSSESSES, OR EXHIBITS THE FIREARM.”

Please check with your licensed retailer or state police for additional warnings which may be required by local law or regulation. Such regulations change constantly, and local authorities are in the best position to advise you on such legal matters.

WARNING

YOU RISK PERSONAL INJURY OR DEATH BY HANDLING THIS FIREARM

Before handling any firearm, make sure you know the safety procedures and most importantly, keep the firearm pointed in a safe direction.

Before handling this firearm, read, understand and follow the instructions in this manual. Always keep this manual with the firearm. If you lend, give or sell this firearm, be sure the manual goes with it. If there is anything you do not understand, seek advice from someone qualified in safe handling of firearms. You must ALWAYS obey the following warnings, instructions and safety procedures:

1. Always keep the muzzle pointed in a safe direction.
2. Firearms should be unloaded and secured when not actually in use.
3. Do not rely on your firearm's safety.

WARNING

4. Be sure of your target and what is beyond it.
5. Use only proper ammunition matching the precise gauge of your specified pistol.
6. If your pistol fails to fire when the trigger is pulled, handle with care.
7. Always wear ear and eye protection when shooting.
8. Be sure the barrel is clear of obstructions before shooting.
9. Do not alter or modify your firearm, and have it serviced regularly.
10. Learn the mechanical and handling characteristics of your pistol.
11. Shoot sober!

FOLLOWING THESE SAFETY RULES CAN SAVE YOUR LIFE OR THE LIFE OF SOMEONE ELSE

Get competent firearms instruction in safe handling before using this firearm. Please ask you dealer for names of qualified instructors near you. All guns are extremely dangerous if carelessly handled or used. Remember that the firearm user is the primary “safety” and that reliance on any mechanical safety device should never replace safe handling procedures.

This firearm WILL FIRE if a cartridge is in the chamber and the trigger is pulled while the thumb safety is disengaged.

ALSO, THIS FIREARM DOES NOT HAVE A MAGAZINE DISCONNECT AND WILL FIRE WITHOUT THE MAGAZINE IN THE PISTOL.

DO NOT LOAD THIS PISTOL UNTIL YOU UNDERSTAND HOW IT OPERATES. KEEP this pistol unloaded at all times except when you are ready to fire and are sure of your target.

ALWAYS carry this pistol in a case or original box unloaded.

FOLLOWING THESE SAFETY RULES CAN SAVE YOUR LIFE OR THE LIFE OF SOMEONE ELSE

NEVER point this pistol at anything that is not your intended target even if the pistol is unloaded. When loading, unloading, cleaning or handling, always be sure the muzzle is pointed in a safe direction and always keep your finger off the trigger.

NEVER assume any gun is unloaded. Before handling, check to make sure the chamber is empty. See Unloading Instructions. Make sure you know that this or any firearm is fully unloaded before displaying or handling it. When handling any firearm, keep your fingers away from the trigger at all times until you intend to fire.

Get instructions from a competent firearms instructor before using this or any firearm. Learn from a professional how to handle, load, unload, operate, fire and care for your gun.

NEVER PLAY with your firearm. It is not a toy and can be a very dangerous weapon that can cause serious personal injury or death.

FOLLOWING THESE SAFETY RULES CAN SAVE YOUR LIFE OR THE LIFE OF SOMEONE ELSE

Always keep the gun pointed in a safe direction. Treat every gun as if it is loaded...all the time. **NEVER** point any firearm (loaded or unloaded) at any person or anything you do not intend to shoot. Always keep your gun unloaded until ready to use and make sure that it is unloaded before cleaning.

Keep your finger **OFF** the trigger until you are actually aiming at the target and ready to shoot. Learn to rest your finger outside of the trigger guard.

Never rely on a gun's "safety" to protect you from unsafe gun handling. A safety is only a mechanical device, not a substitute for using common sense and following gun safety procedures.

Never leave a gun unattended or where it could fall.

Store guns and ammunition separately, **beyond the reach of children**. Make sure your guns and ammunition are properly secured so untrained individuals and children will be denied access to your guns and ammunition.

FOLLOWING THESE SAFETY RULES CAN SAVE YOUR LIFE OR THE LIFE OF SOMEONE ELSE

Test your gun's operation and safeties only at a shooting range while the firearm is pointed in a safe direction.

Know your target and what is beyond. Ask yourself what your projectile will hit if it misses the target or passes through the intended target. Remember, a fired projectile can travel over a mile (including a ricochet) and is capable of going through walls. Never shoot at hard flat surfaces or water....bullets ricochet.

Guns and alcohol or drugs do not mix. Do not take any alcoholic beverages and/or drugs before or during shooting activities.

Never pull a gun toward you by the muzzle. Do not climb a tree, cross a ditch or fence with a loaded gun.

Always empty guns before entering a house, car, truck, boat, RV, camp, or any building.

FOLLOWING THESE SAFETY RULES CAN SAVE YOUR LIFE OR THE LIFE OF SOMEONE ELSE

When receiving a gun, always open the action and check to make sure the chamber is unloaded.

NEVER accept anyone's word that a gun is "unloaded" or "empty". You should immediately open the action and check to make sure it is unloaded.

Be careful with **ALL** ammunition. Even "blank" cartridges are deadly at close range due to the muzzle blast. Make sure your ammunition is new and in good clean condition. Do **NOT** oil or grease ammunition as this may damage the cartridge primer. Do **NOT** tamper with or alter the standard factory ammunition.

Keep firearms unloaded when not actually in use. Load the gun only when on the range preparing to fire, and unload it before leaving the range.

Never put your hand over the muzzle of a gun.

FOLLOWING THESE SAFETY RULES CAN SAVE YOUR LIFE OR THE LIFE OF SOMEONE ELSE

ALWAYS WEAR protective shooting glasses and hearing protection when using firearms.

Spectators should be at least 10 feet behind and away from the shooter while the shooter is loading, shooting, and unloading. Spectators should wear eye and ear protection and avoid distracting those shooting their firearms.

Never drop your gun. If you do drop it, unload it and check it for proper function before using it again.

Do **NOT** alter or modify your gun. Do not try to change your gun's trigger pull, because it may affect sear engagement and thereby cause accidental firing.

Do **NOT** remove any internal safety or external safety devices on the firearm. Safety mechanisms are designed to help protect you from personal injury or death.

FOLLOWING THESE SAFETY RULES CAN SAVE YOUR LIFE OR THE LIFE OF SOMEONE ELSE

Properly maintain and keep your gun clean. Keep it in a dry place away from other metals and water. If your gun shows sign of corrosion or improper operation, have it serviced by a competent gunsmith.

Keep the muzzle pointed in a safe direction when loading and unloading your gun. Never point the muzzle at anyone.

If a gun fails to fire when the trigger is pulled, keep it pointed down range at the target for 60 seconds. Sometimes slow primer ignition will cause a “hang fire” and the cartridge will go off after a short pause. After that time period, if it still fails to fire, keep the muzzle pointed in a safe direction and avoid exposure to the breech, as you attempt to unload your firearm.

Never let water, snow, mud, or other material enter the barrel. Always be sure the barrel is free of any obstruction.

FOLLOWING THESE SAFETY RULES CAN SAVE YOUR LIFE OR THE LIFE OF SOMEONE ELSE

Use the correct ammunition for your firearm. Do **NOT** use the wrong size or wrong strength ammunition in your firearm.

Teach children: **1. NOT** to touch guns, bullets, cartridges, shells, flares, or any explosive device and **2.** That if they discover such a dangerous item or weapon, they must immediately report its location to their parents, school teacher, or police.

Remember a firearm has the capability of taking your life or the life of someone else. Be careful with your firearm - an accident is almost always the result of not following basic safety rules.

Basic External Parts of 1911 Pistol



Carbine External Parts



Basic Parts Description

Trigger: All of our triggers are single action. The hammer must be cocked in order for the gun to fire upon squeezing trigger.

Magazine release: Locks and holds the magazine in place. Depress this button to release the magazine.

Slide stop: Locks the slide open once it is pushed up into the slide stop notch, which is located on the left hand side of the slide.

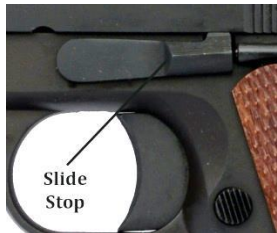

Basic Parts Description

Grip safety: Keeps the gun from firing until it is pressed, as it is by your hand during normal firing procedures. It is located on the back of the gun and is depressed by the palm of your hand when squeezed.



Barrel bushing: Holds the barrel and recoil spring plug in place (no barrel bushing on the Thrasher). Refer to the disassembly section for instructions on its removal.

Recoil spring plug: Holds the recoil spring in place.

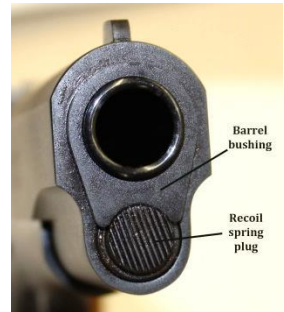

Basic Parts Description

Safety Features:

These 1911 pistols are equipped with a thumb safety that can be activated when the hammer is cocked, preventing the trigger from being pulled. This pistol is also equipped with a grip safety, which prevents the hammer from going forward if the palm of your hand is not pressing the grip safety.

Refer to Figure 1 and 2:



Figure 1 (thumb safety off)



Figure 2 (thumb safety on)

Never squeeze the trigger unless the gun is pointed in a safe direction, even if the safety is activated.

Operation of the Pistol

Note: Due to the tightness between the slide and frame of these pistols, sometimes a “break in” period of 500-1000 rounds is necessary before the firearm will feed and eject reliably. Please do so using factory brand FMJ ammunition.

Use the following diagram for loading your magazine.

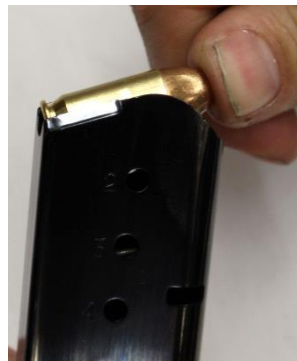
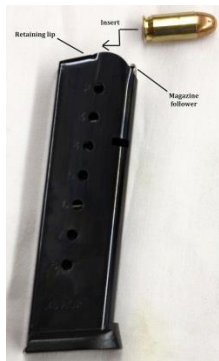

Figure 3

Loading your pistol:

1. Keep your finger off the trigger and outside of the trigger guard at all times, until ready to fire. Press the magazine release button to drop the magazine from the pistol, as shown in Figure 4.
2. Load the magazine as shown in Figure 3, with ammunition pointed towards the front of the magazine (back of the mag is flat).
3. Push the magazine firmly back into the pistol until it locks into place.
4. Point the gun in a safe direction, keep your finger off the trigger, and make sure the thumb safety is off.



Figure 4

5. With your finger still off the trigger, grab the rear slide serrations with one hand (as shown in Figure 5), hold the grip of the gun with your other hand, and pull the slide to the rear as far as it will allow.



Figure 5

6. Release the slide and allow it to go forward under its own power. Do not guide or push the slide forward with your hand.

7. Now the hammer is cocked. A round is loaded and the pistol is ready to fire. Activate the thumb safety, by pushing it up as shown in figure 2, until you are ready to fire.

Warning: The gun is now loaded and ready to fire. Make sure it is pointed in a safe direction.

Firing your pistol:

1. Once the gun is loaded, the thumb safety is activated, and your finger is away from the trigger with the gun pointed in a safe direction, disengage the thumb safety by pushing it down, as in figure 1. Keep your finger off the trigger until ready to fire.

2. Once you aim the gun in a safe direction, squeeze the trigger. The gun will fire. Every time you squeeze the trigger, the gun will fire, the next round will be loaded into the chamber, and the hammer will re-cock, making it ready to fire again.

3. Continue squeezing the trigger until the magazine is empty. The slide will lock open when all the rounds have been fired and the magazine is empty.

4. With the slide locked open, remove the magazine as in figure 4, insert another loaded magazine, and do one of two things: press down the slide stop to release the slide, which will load the first round; or pull back slightly on the rear of the slide and release, which will deactivate the slide stop and the first round will load into the chamber as the slide springs forward. **Always make sure your finger is outside of the trigger guard during this process.**

Note: If the slide did not lock open after firing the last round, remove the magazine, pull back the slide and lock it open, as in Figure 6, by pushing the slide stop into the slide stop notch on the slide. Check the chamber (Figure 8) to ensure there is no ammunition still in the chamber. Then have the gun checked by a licensed gunsmith, or call Iver Johnson Arms directly.

WARNING:

If you want to stop firing before the last round is fired, follow the unloading instructions listed below. Never attempt to manually lower the hammer with the gun loaded. Once again, make sure your finger is off the trigger and outside of the trigger guard when following the unloading procedures.

Unloading your pistol:

Always unload your pistol after every use and before cleaning or storage.

1. With the thumb safety on and the gun pointed in a safe direction, press the magazine release button and drop out the magazine.

WARNING: This gun will fire with no magazine in the pistol.

2. Keeping your finger off the trigger and out of the trigger guard, disengage the thumb safety by pushing it down. The gun can now fire so keep your finger off the trigger.

3. Grasp the rear of the slide by the serrations with one hand, hold the grip of the pistol with your other hand and pull the slide to the rear as far as possible. Refer to Figure 5. The cartridge in the chamber will eject. If it does not, lock the slide open by engaging the slide stop, as in Figure 6, and take the firearm to a licensed gunsmith for inspection.
4. To lock open the slide, engage the slide stop by continuing to hold the slide to the rear, and now push the slide stop up so it engages with the slide stop notch on the slide. Refer to Figure 6. The slide will now remain open.



Figure 6

5. Visually check the chamber of the barrel to ensure there is no cartridge in the chamber (Figure 8).

Cleaning your Firearm

(Skip to page 42 if you have the model Thrasher)

Disassembly:

You should disassemble and clean your firearm before its first use. When the firearm is new, machine oils inside and outside the firearm should be cleaned off. Once cleaned, make sure to oil your firearm with gun lubricant before shooting.

1. Ensure the magazine is removed and the gun is unloaded by visually checking the chamber area of the barrel with the slide locked open (Figure 8).

The springs in the gun are strong and could cause items to fly out, which could injure your eyes. For this reason, you should wear safety glasses when disassembling your pistol and handle the springs with care.



Figure 7

2. With the muzzle pointing upwards, rest the butt of the gun on a work bench.

3. Press down on the recoil spring plug, just under the barrel muzzle, and while pressing down, turn the barrel bushing clockwise about a 1/4" turn, as in figure 9 (we recommend using a 1911 barrel bushing tool to turn the bushing). This will free the recoil spring plug.

****Warning – see next page****



Figure 8

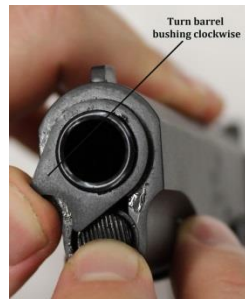

Figure 9

AT THIS TIME, THE RECOIL SPRING CAN FLY OUT. Keep pressure on the recoil spring plug, and gradually release it until all tension is gone (Figure 7).

4. Cock the hammer. Pull the slide back until the disassembly notch, page 23, is directly in line with the lug on the slide stop. Remove the slide stop pin by pushing the slide stop pin from the right side of the frame, in Figure 10, and pulling the slide stop out from the left side of the frame, in Figure 11. Remove the slide stop completely.

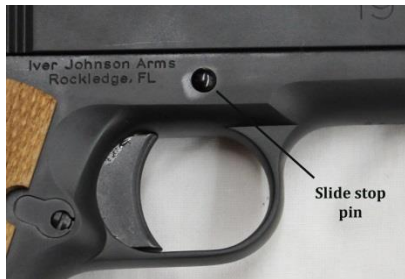

Figure 10



Figure
11

5. Once the pin is removed, remove the slide by sliding it forward off the gun (Figure 12).



Figure 12

6. Remove the recoil guide rod and spring (Figure 13).



Figure
13

7. Turn the barrel bushing counter-clockwise until it stops, which should be about 1/8th of a turn past center. Then slide the barrel forward and off the front of the slide. At the same time, you will remove the barrel bushing by pulling it out with the barrel. Make sure the barrel link is fully forward so it fits out the front of the slide (Figure 14).



Figure 14

Do not strip your pistol any further than we have noted here. This is the only stripping necessary for cleaning your pistol. If further maintenance is required or further disassembly is required, take your gun to a licensed gunsmith.

8. Once your gun is disassembled, use a gun solvent to clean the inside of the slide, frame, and barrel. Contact your local gun dealer to ensure you use the proper gun cleaning tools. Be sure to clean well into the rails of the slide and frame (Figure 15). Once clean and the solvent has been removed, apply gun oil to the rails of the slide and frame (Figure 15). You can also apply a light coat of oil to any visible internal parts of the firearm. Gun oil is necessary to ensure the firearm functions properly.



Figure 15

Reassembly:

To reassemble the firearm, reverse the disassembly instructions.

Reassembly tips:

When installing the slide stop, after the barrel is assembled into the slide and you have guided the slide onto the rails of the frame, make sure the barrel link is in line with the slide stop pin hole, so the slide stop pin goes through the frame and the barrel link.

(Skip to page 49 if you do not have the model Thrasher)

Thrasher Disassembly

When disassembling your pistol, you should always wear safety glasses. There are springs in the pistol that could become dislodged and cause severe eye damage.

Step 1. Before disassembling your pistol, always check to ensure the magazine is removed and the chamber is empty of any ammunition.

With the gun pointed in a safe direction, release the magazine by pressing the magazine release button and taking out the mag, (Figure A).

Step 2. With your finger away from the trigger and outside of the trigger guard, pull back the slide and visually check to ensure there is no round still loaded in the chamber, (Figure B).



Figure A

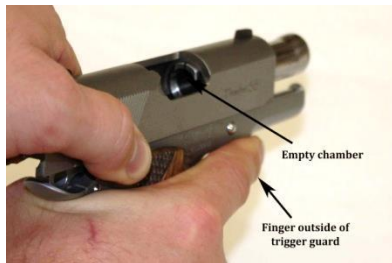

Figure B

Step 3. Pull the slide back until the slide stop lug is in line with the slide stop notch, (Figure C). Never put your hand in front of the barrel when doing so, as a safety precaution.



Figure C

Step 4. With the slide stop in line with the slide stop notch, push the slide stop pin from the right side of the gun, (Figure D).



Figure D

Step 5. Pushing the slide stop pin from the right side will slightly push out the slide stop on the left side. Now you can pull the slide stop completely out of the pistol, (Figure E).



Figure E

Step 6. Once the slide stop is removed, pull the slide forward and completely off of the gun, (Figure F).



Figure F

Step 7. To remove the recoil spring assembly, which is holding the barrel in place, pull back the recoil spring plate (Figure G). While holding back the recoil spring plate, pull the recoil spring assembly out and away from the slide, (Figure H).



Figure G



Figure H

Step 8. Remove the recoil spring bushing, once the recoil spring assembly has been removed, (Figure I).



Figure I

Step 9. Slide the barrel out the front of the slide (Figure J).

STOP!!! No further disassembly is required for the cleaning of this firearm. If further disassembly is needed, take your pistol to a certified gunsmith.

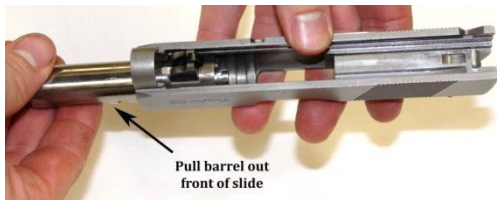

Figure J

Thrasher Reassembly

To reassembly this firearm, reverse the disassembly instructions.
Helpful hints:

1. When installing the recoil spring assembly, make sure the recoil spring plate is pressed firmly against the barrel link, and the recoil spring assembly is level with the slide, (Figure K).
2. Once the slide is completely on the gun & the barrel link (Figure K) is in line with the slide stop pin hole, put the slide stop pin half way through the pin hole, (Figure L).

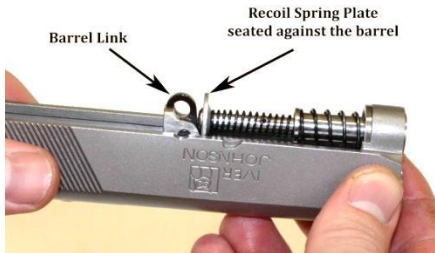

Figure K



Figure L

3. With the slide stop pin half way in the hole, pull back the slide until the slide stop notch lines up with the slide stop lug. Now press in the slide stop until it seats firmly against the frame of the gun, (Figure M).



Figure M

Checking your gun after reassembly:

1. With no magazine in the pistol, pull the slide all the way back and release. It should go completely forward over the empty chamber. The hammer should remain cocked.
2. Push the thumb safety up to activate it, with the hammer cocked back. Squeeze the trigger, the hammer should not fall forward.
3. Take off the thumb safety and squeeze the trigger. The hammer should fall forward. A dummy safety round should be used when testing, to ensure the care of your firing pin components. They can be purchased from Iver Johnson Arms. Call us to place an order.
4. Now insert an empty magazine and pull back the slide. The slide should lock open. The firing pin should not be visible outside of the firing pin hole on the slide. If it is, take the pistol immediately to a certified gunsmith for evaluation.

5. Release the slide stop and guide the slide back to its closed position. Squeeze the trigger to release the hammer. NOTE: This is a single action semi-automatic pistol. If the hammer is down against the slide or in half cock position, and not fully cocked, the trigger will not actuate the hammer. The firearm cannot fire until the hammer is fully cocked, either by hand or by the slide.

You should clean your pistol after every use in order to help prevent corrosion and keep your pistol functioning correctly. If your pistol gets wet, clean it as soon as possible. If your pistol is not being used, you should clean it at least twice a year, and keep it well oiled.

1911 Parts Illustration

This parts illustration section is only a reference for you to identify parts of your firearm. If you are in need of adjustments or repair, you must take your pistol to a certified gunsmith, or contact Iver Johnson Arms.

**Iver Johnson
1911 style pistol**

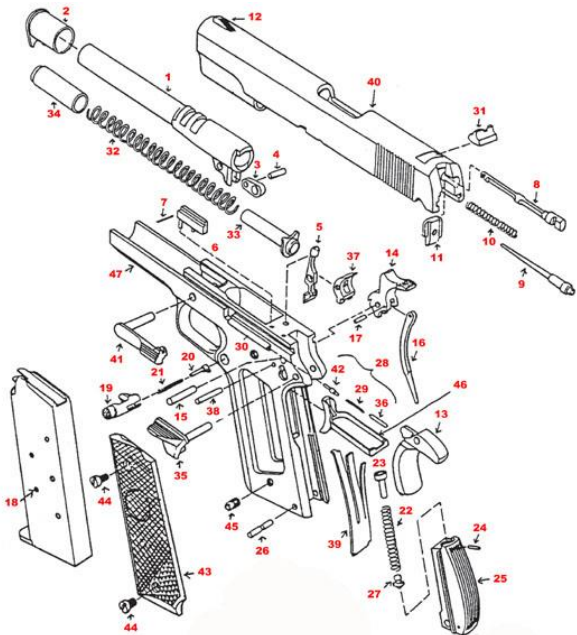

1911 Parts Illustration List

1. Barrel	17. Hammer strut pin	33. Recoil spring guide
2. Barrel bushing	18. Magazine	34. Recoil spring plug
3. Barrel link	19. Magazine catch	35. Thumb safety
4. Barrel link pin	20. Magazine catch lock	36. Safety lock plunger
5. Disconnect	21. Magazine catch spring	37. Sear
6. Ejector	22. Mainspring	38. Sear pin
7. Ejector retaining pin	23. Mainspring cap	39. Sear spring
8. Extractor	24. Mainspring cap pin	40. Slide
9. Firing pin	25. Mainspring housing (flat)	41. Slide stop
10. Firing pin spring	26. Mainspring housing pin	42. Slide stop plunger
11. Firing pin stop	27. Mainspring housing pin retainer	43. Grip
12. Front sight	28. Plunger tube assembly	44. Grip screw
13. Grip safety	29. Plunger spring	45. Grip screw bushing
14. Hammer	30. Plunger tube	46. Trigger
15. Hammer pin	31. Rear sight	47. Frame (Receiver)
16. Hammer strut	32. Recoil spring	

Thrasher Exploded View

This parts illustration section is for reference only, so you can identify parts of your gun. If you are in need of adjustments or repair, you must take your firearm to a certified gunsmith.

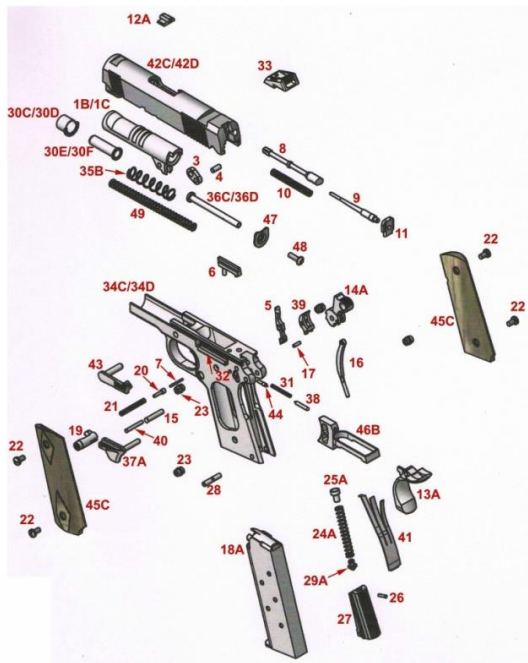

Thrasher Part Description List

Drawing Ref. #	Part or Assy. Name	Ordnance Drawing and Part Number	Drawing Ref. #	Part or Assy. Name	Ordnance Drawing and Part Number
1B.	Barrel-Thrasher Blue	7791193B	30C.	Recoil Spring Plug-Thrasher Blue	5013201C
1C.	Barrel-Thrasher Stainless	7791193C	30D.	Recoil Spring Plug-Thrasher Chrome	5013201D
3.	Barrel Link	5013198	30E.	Secondary Plug Thrasher Blue	5013201E
4.	Barrel Link Pin	5013199	30F.	Secondary Plug Thrasher Chrome	5013201F
5.	Disconnecter	6008603	31.	Plunger Spring	5013194
6.	Ejector	6019024	32.	Plunger Tube	6008594
7.	Ejector Retaining Pin	5013203	33A.	Rear Sight Novak	5013196A
8.	Extractor	6008598	34C.	Frame-Thrasher Stainless	6535359C
9.	Firing Pin	6008599	34D.	Frame-Thrasher Blue	6535359D
10.	Firing Pin Spring	5013204	35B.	Recoil Spring-Thrasher	5013200B
11.	Firing Pin Stop	5013205	36C.	Recoil Spring Guide Thrasher - Blue	6008597C
12A.	Front Sight-Thrasher	5013197A	36D.	Recoil Spring Guide Thrasher - Chrome	6008597D
13A.	Safety Grip Beavertail	6501828A	37A.	Safety Lock-Gl	5503840A
14A.	Hammer Round	5503839A	38.	Safety Lock Plunger	5013195
15.	Hammer Pin	5013206	39.	Sear	7268068
16.	Hammer Strut	6008600	40.	Sear Pin	5013211
17.	Hammer Strut Pin	5013207	41.	Sear Spring	6008602
18A.	Magazine-Thrasher	5508695A	42C.	Slide-Thrasher Stainless	7790314C
19.	Magazine Catch	6008609	42D.	Slide-Thrasher Blue	7790314D
20.	Magazine Catch Lock	5013218	43.	Slide Stop	6008595
21.	Magazine Catch Spring	5013217	44.	Slide Stop Plunger	5013193
22.	Grip Screw (4)	6019023	45C.	Grip Panel-Thrasher	5564063C/5564062C
23.	Grip Screw Bushing (4)	6019022	46B.	Trigger Assembly	6147780B
24A.	Hammer Spring -Thrasher	5013208A	47.	Guide Plate	6008597E
25A.	Mainspring Cap -Thrasher	5013209A	48.	Guide Plate Screw	6008597F
26.	Main Spring Cap Pin	5013210	49.	Recoil Spring 2-Thrasher	5013200C
27A.	Mainspring Housing-Thrasher	5503841A			
28.	Mainspring Housing Pin	5013212			
29A.	Mainspring Housing Pin Retainer-Thrasher	5013213A			

Limited Warranty

This Iver Johnson Arms, Inc. firearm is warranted only to the original buyer, when bought new, for ONE YEAR from date of purchase, and is not transferrable. It is warranted against defects in material and workmanship. All parts and labor are covered by Iver Johnson Arms at our option. Shipping of the firearm to our repair facility must be paid for by the customer. We will pay for return shipping of the firearm to the customer, if the firearm is covered under warranty. Damage caused by failure to perform normal maintenance to the firearm, damage caused by the use of reloaded, high velocity, high pressure, or other non-standard ammunition, or any other unauthorized repair, modification, abuse, or alteration to the firearm is NOT covered by this Limited Warranty and the warranty is void. There will be a charge for any repairs not covered under this warranty, and shipping to and from our facility will be charged to the customer.

You will need to enclose a copy of your retail purchase sales receipt with your gun when you ship it to us. This will show us when your firearm was purchased, and we will need this to qualify you for warranty work.

Limited Warranty (con't)

For warranty work, please email us to discuss your repair needs with one of our representatives, service@iverjohnsonarms.com. If warranty work is approved, you will then send the firearm, including all parts and empty magazine, to Iver Johnson Arms, Inc. We will give you the physical ship to address for your return. It is not the PO box as shown on this manual. Make sure you include your return address and a contact phone number, along with a short description of the problem with the gun. Please ship us the firearm directly, or have your local gun dealer ship us the firearm. You will be required to pay for freight to our facility.

NOTICE: It is illegal to ship a firearm with ammunition in the same package. Be sure your firearm is empty of all ammunition before shipping.

WARNING

Children are attracted to and can operate firearms that can cause severe injuries or death. Prevent child access by always keeping guns locked away and unloaded when not in use. If you keep a loaded firearm where a child obtains and improperly uses it, you may be fined or sent to prison.

ADVERTENCIA

A los niños les atraen las armas de fuego y los pueden hacer funcionar. Ellos pueden causarse lesiones graves y la muerte. Evite que los niños tengan acceso a las armas de fuego guardándolas siempre con llave y descargadas cuando no las esté utilizando. Si usted tiene un arma de fuego cargada en un lugar en el que un niño tiene acceso a ella y la usa indebidamente. Le pueden dar una multa o enviarlo a la cárcel.

Iver Johnson Arms, Inc.
PO Box 561294
Rockledge, FL 32956
www.iverjohnsonarms.com

1-1-22