



**INSTRUCTION MANUAL  
FOR OVER & UNDER**

**READ THE INSTRUCTIONS AND  
WARNINGS IN THIS MANUAL CAREFULLY  
BEFORE USING THIS FIREARM**

# CONTENTS

● GUN SAFETY RULES .....	1-2
● NOMENCLATURE .....	3
● ASSEMBLY INSTRUCTIONS .....	4-5-6
● OPERATING INSTRUCTION .....	6-7-8
● LOADING & FIRING .....	8-9
● UNLOADING .....	9
● DISASSEMBLY INSTRUCTION .....	10
● USE OF THE «CHOKES» .....	11-12
● HAZARDOUS MATERIAL WARNING .....	12
● EXPLODED VIEW .....	13
● PARTS LIST .....	14
● SERVICE INSTRUCTIONS .....	15
● PURCHASER'S RECORD .....	16



**WARNING :** This product can expose you to chemicals, including lead, which are know to the State of California to cause cancer and birth defects or other reproductive harm. For more information go to [www.P65Warnings.ca.gov](http://www.P65Warnings.ca.gov).

## **GUN SAFETY RULES**

**Read very carefully this instruction manual before handling this firearm. Incorrect handling may result in serious injuries or death to you or bystanders**

Always keep the muzzle pointed in a safe direction. Watch the muzzle at all times: never point a gun, accidentally or intentionally, at any person or anything you do not intend to shoot. Identify the target before shooting.

Always treat a gun as if it is loaded- it may be!

Keep your finger off the trigger while operating the action and at all other times until you are ready to shoot.

Keep the safety «on» or in the «safe» position at all times until you are ready to fire. Do not rely on your gun's safety, the safety on any gun is a mechanical device and is not intended as a substitute for common sense or safe gun handling.

Learn how your gun functions and handles. If you do not thoroughly understand the proper use and care of your gun, seek the advise of someone who is knowledgeable.

Be sure the barrel is clear of any obstructions before loading. Make it a habit to check the barrel every time before loading.

Be sure you use the proper ammunition. A 20 gauge shell will enter a 12 ga chamber far enough so that 12 ga shell can be loaded behind it. Also, a 3 inch shell may fit into a 2 <sup>3</sup>/<sub>4</sub> inch chamber, but the crimp at the mouth of the shell will unfold into the forcing cone. If either of these things occur and you fire the gun, the gun will explode, damaging the gun and possibly causing serious injury or death to you and those around you.

## **GUN SAFETY RULES**

**Read very carefully this instruction manual before handling this firearm. Incorrect handling may result in serious injuries or death to you or bystanders**

Store guns unloaded, separate from any ammunition, and out of the reach of children.

Wear protective shooting glasses and adequate ear protection when shooting.

Never climb or jump over anything, such as a tree, fence, or ditch with a loaded gun. Open the barrel, remove the shells and hand the gun to someone else or place it on the ground on the other side of the obstacle before crossing it yourself. Do not lean a gun against a tree or other object: it could fall and possibly discharge.

Do not alter or modify any part of the firearm.

Do not shoot at a hard surface or at water- Bullet and shot can ricochet or bounce off and travel in unpredictable directions with great velocity.

Never transport a loaded gun. Do not place a loaded gun into a vehicle. The gun should be unloaded and placed into a case when not in use.

Never drink alcoholic beverages before or during shooting.

# NOMENCLATURE

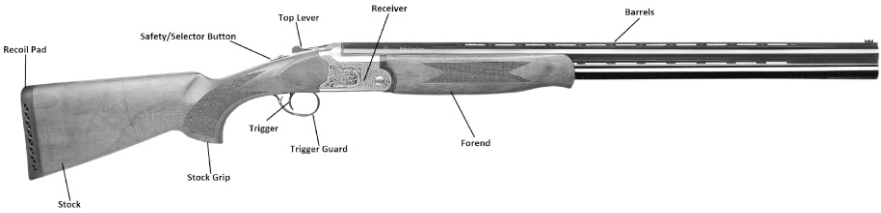

## Main Parts

Recoil Pad	Trigger
Buttstock	Trigger Guard
Safety / Selector	Receiver
Top Lever	Forend
Stock Grip	Barrels

**WARNING:** Read and understand all instruction and warnings in this manual BEFORE using this shotgun. It is important to learn the parts of your shotgun and their functions before using this firearm.

# ASSEMBLY INSTRUCTIONS



Before assembling the shotgun, make sure there are no shotshells in the chambers.

**1.** Remove the forend from the barrel by pulling off the lever (FIG. 1) forward toward the muzzle end and pivot the forend away from the barrel (FIG. 2)

**2.** Apply a small amount of high quality lubricant to all surfaces on both sides marked with red arrow (FIG. 3)

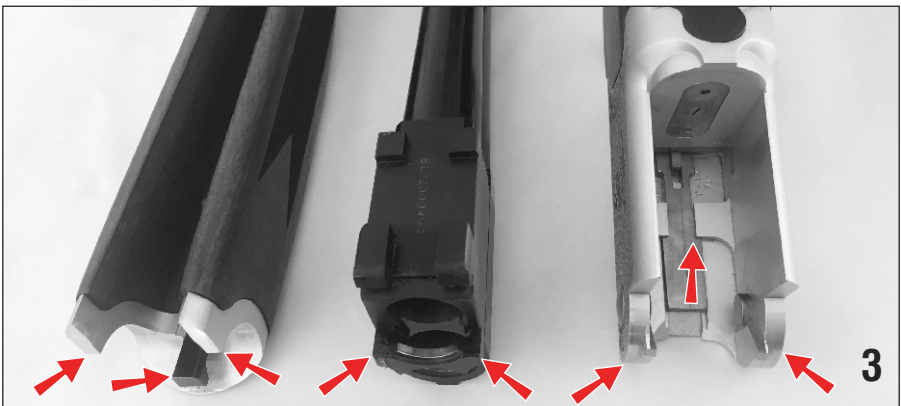

**3.** Attach barrels to the action by pushing the top lever to the right and engaging the dual hinge pin bearing notches on each side of the barrel. Hold the barrels with the muzzle at a downward angle with respect to the receiver. Once the bearings are properly seated, lift up on the barrels and close the action (FIG. 4)

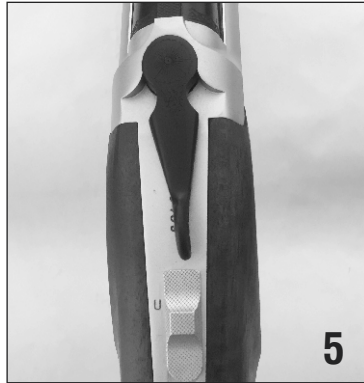

**4.** When the barrels are closed properly against the receiver, the Top Lever will return toward the center of action. (FIG. 5)

**5.** Attach the forend to the barrels by placing the metal part of the forend assembly against the receiver. Pivot forend toward the barrel to the closed and locked position against the barrels. (FIG. 6) Check to make sure the lever on the forend has fully engaged with the barrels by trying to pull the front tip of the forend away from the barrel after installation. If forend can come off, re-install and squeeze the forend tighter to the barrels.



**6.** For Aluminium Receiver models , you can adjust the Top Lever's tightness level as you wish by assembling the forearm onto the grip as pictured below. And if your forend is loosen up you can make it tighter with this way. (FIG. 7)

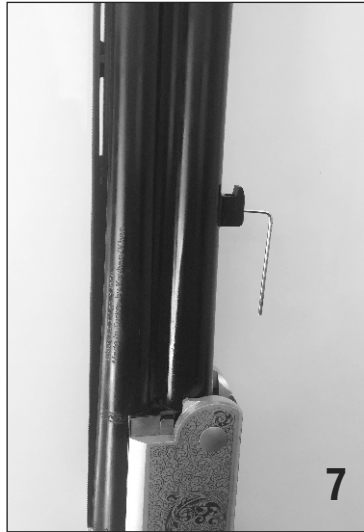
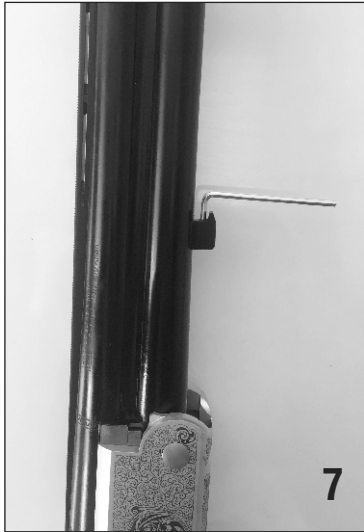

**WARNING :** BEFORE ASSEMBLING THE SHOTGUN, CHECK THE BARREL. BARREL AND CARTRIDGE CHAMBER MUST BE CLEAN AND THERE SHOULD BE NO OBSTRUCTIONS IN THEM.

## **OPERATING INSTRUCTIONS**

### **TOP LEVER**

The Top Lever controls the locking of the breech of the barrels to the receiver. To open the gun, move the Top Lever to its extreme right hand position and ease down the barrels.

The Top Lever will remain in the «OPEN» position until the barrels are again closed & locked. The Top Lever will then automatically return toward the center position. (FIG. 5)



## SAFETY BUTTON

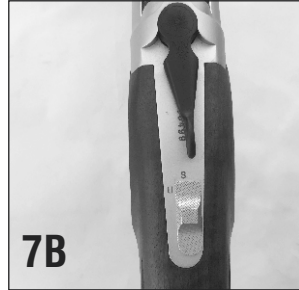
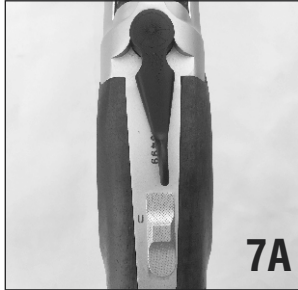

Safety is first and foremost when handling any firearm. To engage the safety, slide the safety button fully rearward.

There is a visible «S» to help guide you. To disengage the safety in order to fire the shotgun, slide the safety button fully forward. Always keep the safety in the «SAFE» position until you are ready to fire. (FIG. 7A and FIG. 7B)

When the safety is engaged in the rearward position it can be moved to the left or right depending on which barrel the shooter wants to shoot first. Moving the safety selector to the right will allow the shooter to shoot the bottom barrel first; there will be a visible “U” on the left side of the safety indicating UNDER. Moving the safety selector to the left will allow the shooter to shoot the top barrel first; there will be a visible “O” on the right side of the safety indicating OVER. The safety selector does not need to be switched back to the opposite side to shoot the second barrel.

## EXTRACTOR

Your gun is equipped with extractors. When you open the breech of the shotgun, the extractor will partially extract all shells for easy removal by hand. (FIG. 8)

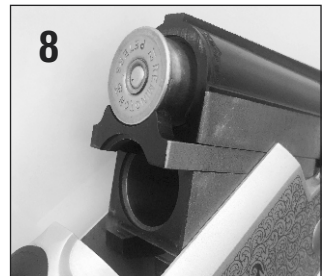

## BARREL CHOKES

This Tristar O&U shotgun is equipped with Beretta/Benelli MOBIL style screw in choke tubes.

## STEEL SHOT WARNING!

Steel shot (up to and including size 2 shot) should not be fired through your shotgun with a choke tighter than modified.

If larger than size 2 shot is used, the tightest choke used should be an improved cylinder.

## AMMUNITION

Use only high quality ammunition specifically designed for your gauge of shotgun. The barrel is marked with the size of shotshell it will accept.

If the barrel is marked 3 inch it will accept 3 inch & 2 ¾ inch shotshells.

We do not recommend using slugs in this O&U shotgun, except for cylinder and improved cylinder choke tubes.

## LOADING & FIRING

### WARNING!

1. Always keep your fingers away from the trigger if you do not intend to fire.
2. Always check barrels to see that the firearm is not already locked.
3. While you load the firearm, always point the barrel in a safe direction.
4. Always use the correct ammo size for which your firearm is chambered.
5. Always keep the safety «ON» while loading your firearms.

## **LOAD THE FIREARM AS FOLLOWS :**

1. Put the safety «ON» if its disengaged.
2. Take the assembled shotgun and rotate the top lever to the right & break the barrels downward.
3. Make sure the muzzles point down and there is no obstruction in the barrels. Then take proper gauge cartridges and insert them into the upper or lower barrels of your choice or into both barrels for 2 shots.
4. Swing up the barrel completely & lock it in the receiver. While doing this make sure you hear the «click» sound when the barrel is closed, make sure the barrel is locked properly in the receiver & make sure the top lever returns to its center position.

If any of these do not happen this means your shotgun is not assembled correctly. In such a case immediately unload your shotgun and disassemble it & assemble your shotgun again.

## **UNLOADING**

**WARNING! : Read & understand all instruction and warnings in this manual BEFORE using this shotgun.**

**Always keep the shotgun pointed in a safe direction & the safety in the «safe» position**

**Before unloading, check to assure that the safety is in the «safe» position. Open the action by pushing the top lever all the way to the right and pulling the barrels downward fully.**

**This will extract any fired or unfired shells in the chambers, for easy removal. (FIG. 9)**



## DISASSEMBLY

**WARNING!** Always make sure the shotgun is completely unloaded before disassembly

Disassemble, clean and oil your shotgun at regular intervals or when it has been exposed to sand, water or other adverse conditions.

### To disassemble your shotgun:



1. Remove the forend by pulling the forend release lever and pivoting the forend away from the barrel.
2. Push the top lever to the right to disengage the action.
3. Remove the barrel assembly Further disassembly is not recommended and not necessary for regular maintenance. (FIG. 10)



**CAUTION :** Always unload your gun and store it and ammunition separately in locked receptacles out of children's reach and sight, minimizing the risk that the gun and ammunition could be easily available for loading and firing.

**USE YOUR SHOTGUN CAREFULLY AND SAFELY**

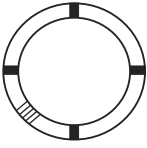
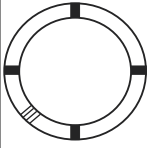
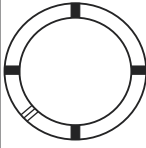
## USAGE OF THE CHOKES

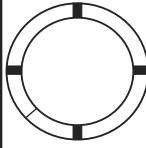
	SKEET	IC	M	IM	F
CHOKE TUBE					
BBLS	CL	HHHH	HHH	HH	H

The choke controls how open or tight the pattern of the shot will be. The chart above lists the chokes available (from open to tight), and the core spending marks that indicate the specific choke.

Never fire your gun or run cleaning tools through a barrel that uses a choke tube without having a choke installed. The threads of the choke tube and the internal threads of the barrel should be cleaned after use and before installation of the tube.

To install a tube, insert the tube into the top of the barrel and tighten with your fingers. Once the tube is finger tightened, tighten the rest of the way with the appropriate choke tube wrench until the tube is snug. DO NOT over tighten or forcefully tighten with the wrench.

## IMPORTANT - USAGE OF STEEL SHOT

based on the pattern performance of shot shells loaded with lead shot. When using steel shot shells, you will notice a different performance in pattern density versus the established lead shot pattern, because steel shot is harder and lighter than lead shot.

## **You should be aware of the following differences and cautions :**

Never shoot steel shot loads in a full choked barrel or an improved modified choked barrel. To do so may cause the barrel to swell or rupture.. In general, steel shot fired with a modified choke will produce the equivalent of a lead full choke pattern. This will be true of all steel shot sized up to and including no.2. The established improved cylinder chokes will produce the equivalent of a (lead) modified pattern.

All steel shot sized larger than no. 2, and including special sized such as F, T, etc., should be used only with improved cylinder chokes. These steel shot sizes, when used in an improved cylinder choke, will produce equivalent to (lead) full choke patterns. The established cylinder choke or bore will produce the equivalent of a modified (lead) pattern.

Additional information concerning the use of steel shot is available from the ammunition companies.

## **HAZARDOUS MATERIAL WARNING**

Discharging firearms in poorly ventilated areas, cleaning firearms, or handling ammunition, may result in exposure to lead and other substances known to cause birth defects, reproductive harm, and other serious injury. Have adequate ventilation at all times.

Wash hands thoroughly after exposure.

# EXPLODED DIAGRAM

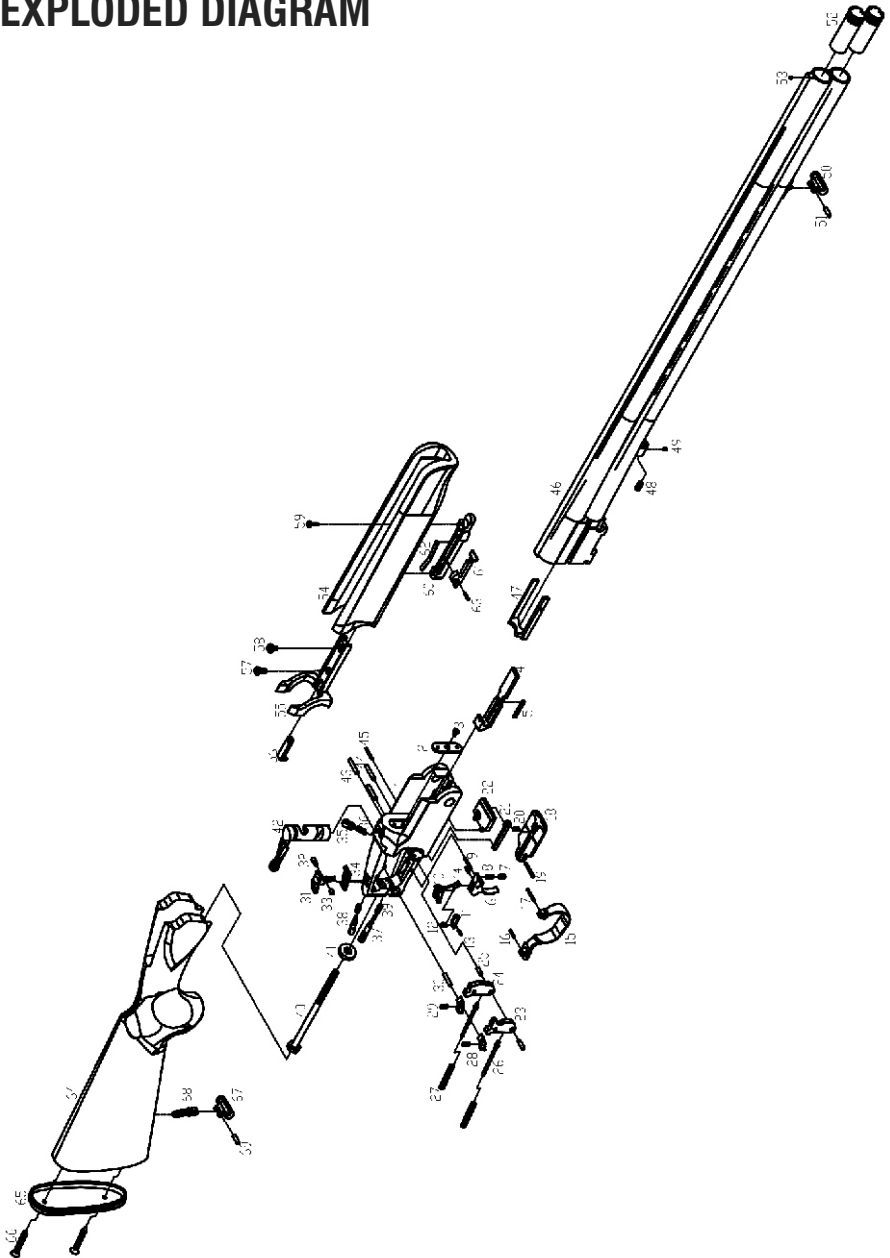

PART #2 & PART #3 WILL BE ONLY ON THE ALUMINIUM RECEIVER MODEL

# PARTS LIST

PARTY	QTY	PART NAME	PARTY	QTY	PART NAME
1	1	RECEIVER	36	1	TOP LEVER SPRING
2	1	RECEIVER PLATE	37	1	FIRING PIN RIGHT
3	1	RECEIVER PLATE SCREW	38	1	FIRING PIN LEFT
4	1	COCKING ROD	39	2	FIRING PIN SPRING
5	1	COCKING ROD SPRING	40	1	STOCK BOLT
6	1	TRIGGER	41	1	STOCK BOLT WASHER
7	1	TRIGGER SCREW	42	1	TOP LEVER
8	1	TRIGGER SPRING	43	2	FIRING PIN RETAINING PIN
9	1	TRIGGER PIN LONG	44	1	FIRING PIN RETAINING PIN
10	1	SELECTOR BLOCK	45	1	TOP LEVER RETAINER PIN
11	1	SELECTOR BLOCK PLUNGER	46	1	BARREL
12	1	SELECTOR BLOCK SPRING	47	1	EXTRACTOR
13	1	SELECTOR BLOCK PIN	48	1	FOREND SPRING
14	1	TRIGGER PIN SHORT	49	1	FOREND PIN
15	1	TRIGGER GUARD	50	1	SLING SWIVEL (FRONT)
16	1	TRIGGER GUARD PIN SHORT	51	1	SLING SWIVEL PIN
17	1	TRIGGER GUARD PIN LONG	52	1	CHOKES
18	1	RECEIVER BOTTOM PLATE	53	1	FRONT SIGHT
19	1	RECEIVER BOTTOM PLATE PIN	54	1	FOREND
20	1	TOP LEVER RETAINER SPRING	55	1	FOREND IRON
21	1	TOP LEVER RETAINER LOCK	56	1	COCKING ARM
22	1	BLOCKER PLATE	57	1	FOREND IRON LONG SCREW
23	1	HAMMER RIGHT	58	1	FOREND IRON SHORT SCREW
24	1	HAMMER LEFT	59	1	FOREND LATCH SCREW
25	2	HAMMER PIN	60	1	FOREND LATCH FRAME
26	2	HAMMER SPRING GUIDE ROD LEFT&RIGHT	61	2	FOREND LATCH
27	2	HAMMER SPRING	62	1	FOREND LATCH FRAME SPRING
28	2	SEAR (LEFT & RIGHT)	63	1	FOREND LATCH PIN
29	2	SEAR SPRING (LEFT & RIGHT)	64	1	STOCK
30	1	SEAR PIN	65	1	RECOIL PAD
31	1	SAFETY/SELECTOR	66	2	RECOIL PAD SCREW
32	1	SAFETY PIN LEFT/LONG	67	1	SLING SWIVEL (REAR)
33	1	SAFETY PIN RIGHT/SHORT	68	1	STOCK SLING SWIVEL SCREW
34	1	SAFETY SELECTOR PLATE	69	1	STOCK SLING SWIVEL PIN
35	1	TOP LEVER SPRING PLUNGER			



# **SERVICE INSTRUCTIONS**

## **PARTS**

To order parts, please be ready with the following information :  
Your name, address, telephone number, firearm serial number, make and model and payment information.

Call TRISTAR Service Department (816) 421-1400

## **FOR SERVICE**

Ship the firearm prepaid to :  
TRISTAR ARMS INC.  
1816 Linn St.  
North Kansas City,  
MO 64116

## **THANK YOU**

Thank you for purchasing a TRISTAR shotgun. We are sure this gun will bring you years of hunting and/or shooting pleasure.

Your satisfaction is the key to our success. Please let us know if we can be of service and relay any observations about your guns performance or appearance.

For your questions or comments please visit our website.

[www.tristararms.com](http://www.tristararms.com)

## **PURCHASER'S RECORD**

MODEL NUMBER : \_\_\_\_\_

PURCHASE DATE : \_\_\_\_\_

GAUGE or CALIBER : \_\_\_\_\_

PURCHASE PRICE : \_\_\_\_\_

SERIAL NUMBER : \_\_\_\_\_

STORE NAME : \_\_\_\_\_



**Tristar Arms, INC.**  
1816 Linn Street  
North Kansas City, MO 64116  
PHONE : 816-421-1400  
[service@tristararms.com](mailto:service@tristararms.com)