

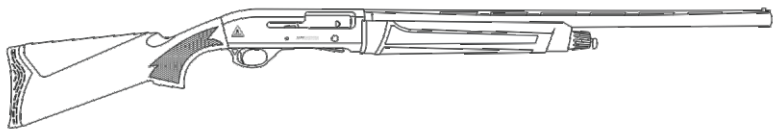

12 GA SEMI AUTOMATIC SHOTGUN



OWNER'S MANUAL



This owner's manual contains valuable operating and safety information. Read and understand the manual fully before handling or operating this firearm. This manual should accompany the firearm at all times, and be transferred with it on change of ownership.

SAFETY FIRST

Please do not use your shotgun before reading safety rules and this manual.

Observe these rules of safe gun handling.

1. Always keep the muzzle pointed in a safe direction. Watch the muzzle at all time, never point a gun. accidentally or intentionally, at any person or anything you do not intend to shoot. Identify the target before shooting; do not shoot at sounds.
2. Always treat a gun as if it is loaded - it may be!
3. Keep your finger off the trigger while operating the action and at all other times until you are ready to shoot.
4. Keep the safety "on" or in the "safe" position at all times until you are ready to fire. Do not rely on your gun's safety, the safety on any gun is a mechanical device and is not intended as a substitute for common sense or safe gun handling.
5. Learn how your gun functions and handles. If you do not thoroughly understand the proper use and care of your gun, seek the advice of someone who is knowledgeable.
6. Do not alter or modify any part of the firearm.
7. Store guns unloaded, separate from any ammunition, and out of the reach of children.
8. Be sure the barrel is clear of any obstructions before loading. Make it a habit to check the barrel every time before loading.
9. Be sure you have and use the proper ammunition. A 20 gauge shell will enter a 12 gauge chamber far enough so that a 12 gauge shell can be loaded behind it. Also, a 3 inch shell may fit into a 2 inch chamber, but the crimp at the mouth of the shell will unfold into the forcing cone. If either of these things occur and you fire the gun, the gun will explode, damaging the gun and possibly causing serious injury or death to you and those around you.
10. Wear protective shooting glasses and adequate ear protection when shooting.
11. Never climb or jump over anything, such as a tree, fence, or ditch, with a loaded gun. Put safety ON. Open the barrel on barrel break shotguns, remove the shells/discharge the chamber on pump and semi-auto shotguns and hand the gun to someone else or place it on the ground on the other side of the obstacle before crossing it yourself. Do not lean a gun against a tree or other object; it could fall and possibly discharge.
12. Do not shoot at a hard surface or at water. Bullet and shot can ricochet or bounce off and travel in unpredictable directions with great velocity.
13. Never transport a loaded gun. DO NOT place a loaded gun into a vehicle. The gun should be unloaded and placed into a case when not in use.
14. Never drink alcoholic beverages before or during shooting.
15. Never try to repair the shotgun on your own if you are not educated or expert of. This may cause un-willed damage to your gun which may seriously injure you or someone around you.
16. Never fire your gun without choke tubes (if comes with interchangeable choke tubes and a thread in the muzzle) snugly tightened in barrels.

ASSEMBLY

In the packing, the shotgun is divided into two parts: receiver and barrel group. (Figure 1)

Be sure the barrel inside and out is clean and out of any obstruction. Loosen the magazine cap and take off the fore-end by pushing straight forward to the muzzle direction. (Figure 2)

Replace the front part of fore-end to the barrel ring. (Figure 3)

Make the bolt group half back by pulling the bolt handle. This will provide you easier assembly. Hold the matched barrel and fore-end together and by following the magazine tube to slide in the barrel ring and fore-end, place the barrel extension until properly the receiver and the barrel fits. Be sure the back of the fore-end is correctly placed to the fore-end plate. (Figure 4)

Tighten the magazine cap to the magazine and release the bolt by pushing the bolt release button on the side of the receiver. (Figure 5)

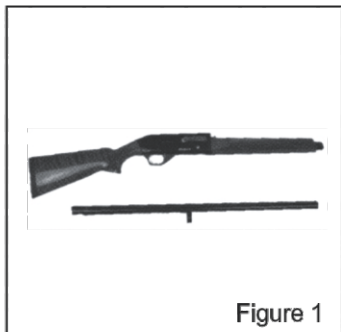

Figure 1

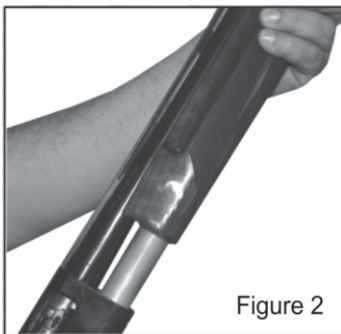

Figure 2

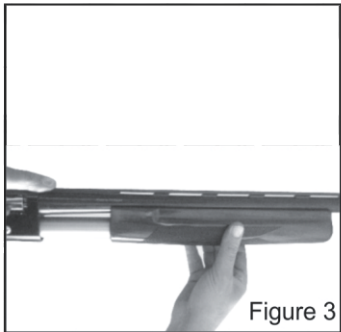

Figure 3

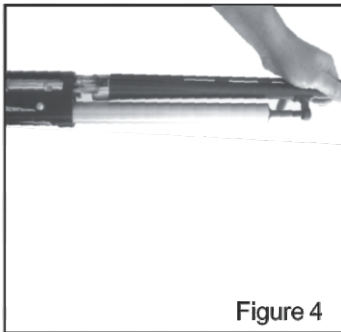

Figure 4

TRIGGER SAFETY

Be sure that the safety is on before loading your shotgun. The safety button is on the trigger group. When you see complete black that means SAFETY ON. When you push the button right to left you will see the red colour and that means the SAFETY OFF. (Figure 6)

LOADING

Make the safety on. Pull the bolt handle completely back and leave. If the bolt group does not release, push the bolt release button. (Figure 5) The carrier will be up to enable you load cartridges in the magazine tube. After you loaded the limit or your desired rounds, press the carrier latch to drop it down getting ready to accept cartridges from the magazine and one will drop on the carrier. (Figure 7)

To chamber the cartridge, pull the bolt handle completely back and release. Now the cartridge is chambered and you can place another cartridge in the magazine instead of the chambered one. Now your shotgun is ready to re and make the safety on only when you are ready and sure to re.

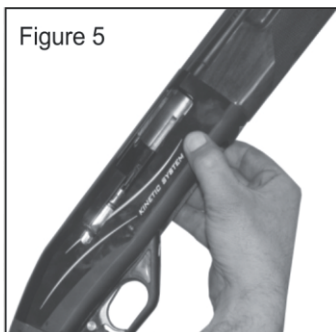

Figure 5

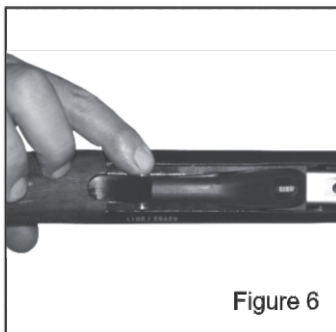

Figure 6

DISCHARGING

Fired shells will be automatically ejected out the receiver. To discharge the cartridges not red, make the safety on rest. Pull the bolt handle completely back to take out the chambered shell if any. If no cartridge is dropped on the carrier, to discharge the cartridges from the magazine press the carrier latch in front of the trigger guard. (Figure 7) By repeating to pull the bolt handle back and release you can discharge all cartridges from the magazine.

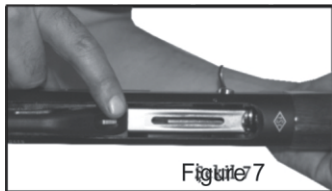

Figure 7

DISMANTLING THE BARREL AND FORE-END
Pull back the bolt handle and lock the bolt group back. Loosen the magazine cap reverse clockwise and take it off. (Figure 8) By holding the fore-end and the barrel together take them off the receiver and the magazine tube in parallel to the tube straight forward. (Figure 9)

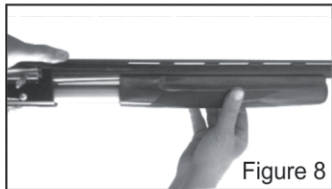

Figure 8

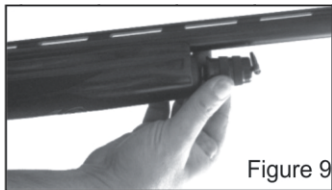

Figure 9

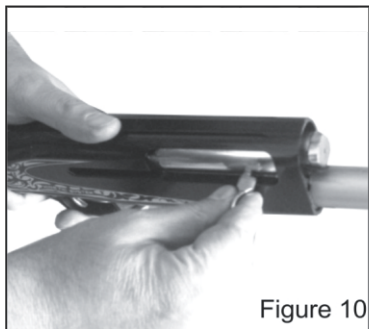

Figure 10

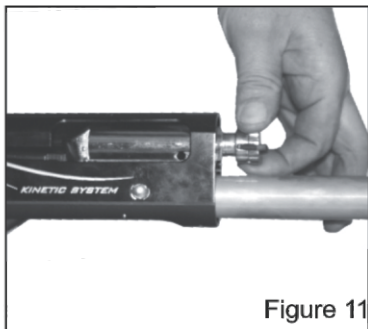

Figure 11

DISMANTLING THE BOLT GROUP

Press the bolt release button to release the bolt group forward. Cover the bolt handle meanwhile to avoid and damage between the bolt group and receiver. Pull o the bolt handle. (Figure 10) Then pull the bolt group straight forward to the muzzle direction, and take it o. (Figure 11)

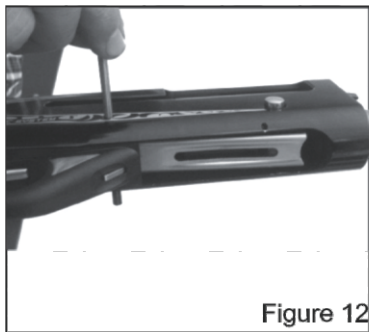

Figure 12



Figure 13

DISMANTLING THE TRIGGER GROUP

In order to dismantle the trigger group, push the trigger group pin with a thin pin and take it o. After that, by pushing rst the front down and pushing the trigger group to the direction of thebarrel and take it o. (Figure 12-13)

MOUNTING THE TRIGGER GROUP

In order to mount the trigger group to its place again after cleaning and lubricating, you can mount back by pushing the trigger group to the direction of the stock and at the same time you must align the holes of the receiver and the trigger group to house the trigger group pin.(Figure 12-13)

GENERAL ASSEMBLY

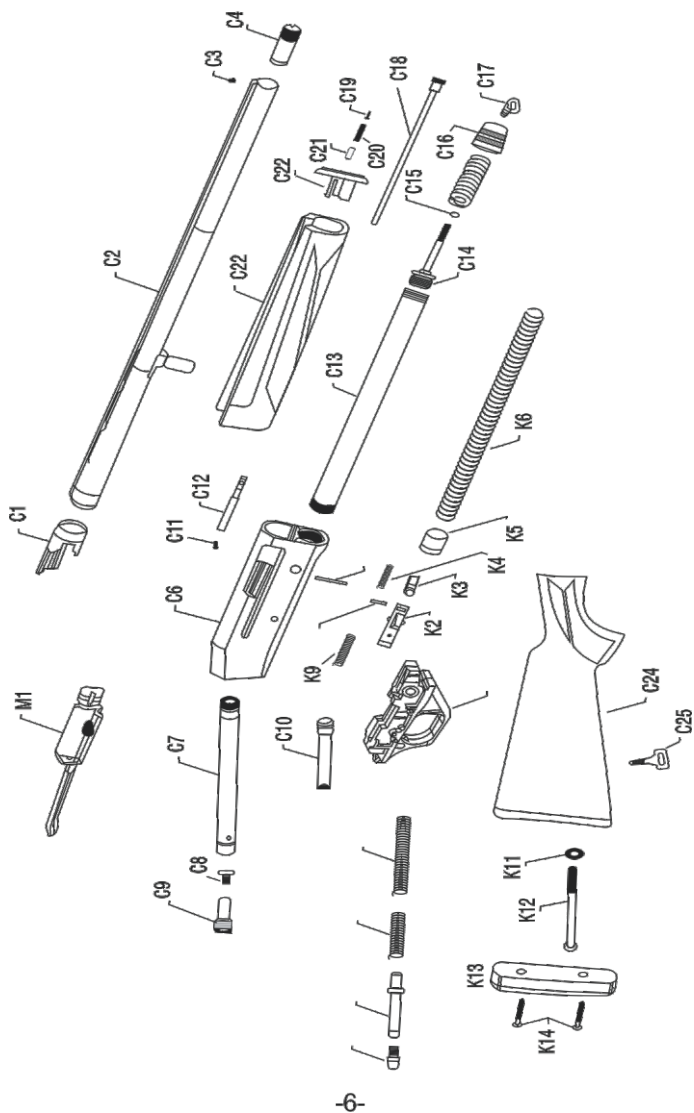

12 GA. GENERAL ASSEMBLY - PART LIST

Stock No	Description	Stock No	Description
c1	Barrel Extension /Breech	C25	Stock Sviwel
c2	Barrel	k1	Trigger Guard
c3	Front Sight	k2	Cartridge Stopper
c4	Choke Tube	k3	Cartridge Stopper Pin
c6	Receiver	k4	Cartridge Stopper Spring
c7	Action Pipe	k5	Cartridge Stopper Wedge
c8	Recoil Wedge	k6	Magazine Spring
c9	Connection Rod	k7	Extractor Pin
c10	Action Inner Rod	k8	Extractor Connection Pin
c11	Ejector Screw	k9	Latch Holder Spring
c12	Ejector	k11	Stock Connection Washer
c13	Magazine Tube	k12	Stock Connection Screw
c14	Magazine Upper Rod	k13	Recoil Pad
c15	Sviwel Ring	k14	Recoil Pad Screw
c16	Connection Nut	k15	Action Recoil Rod Nut
c17	Fore-end Sviwel	k16	Action Recoil Rod
c18	Magazine Limiter	k17	Action Recoil Spring
c19	Fore-end Blocker Pin	k18	Action Spring
c20	Fore-end Blocker Spring		
c21	Fore-end Blocker Screw		
c22	Fore-end Upper Cover		
c23	Fore-End		
c24	Stock		

BOLT GROUP ASSEMBLY-M00

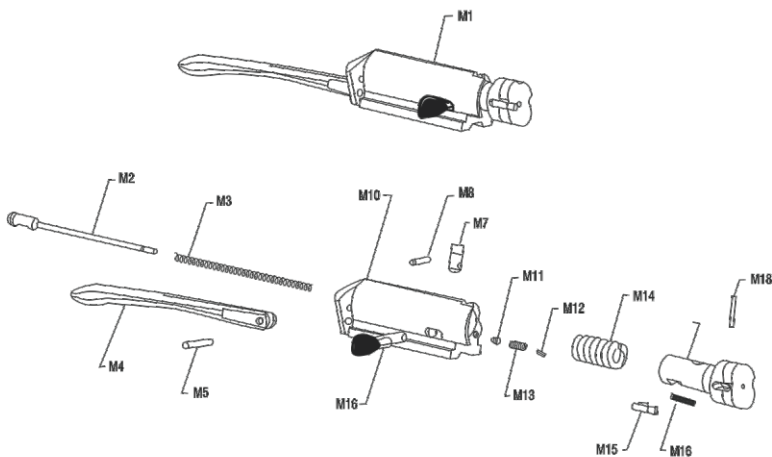

12 GA. BOLT GROUP ASSEMBLY - PART LIST

Stock No	Description	Stock No	Description
m1	BOLT GROUP	M10	BOLT
m2	FIRING PIN	M11	BOLT HANDLE PIN
M3	FIRING PIN SPRING	M12	BOLT HANDLE RETAINING PIN
M4	ACTION BAR	M13	BOLT HANDLE SPRING
M5	ACTION BAR PIN	M14	ROTATING HEAD SPRING
M6	BOLT HANDLE	M15	EXTRACTOR
M8	ROTATING HEAD PI	M16	EXTRACTOR SPRING
		M17	RORATING HEAD
		M18	EXTRACTOR PIN

TRIGGER GROUP ASSEMBLY-B00

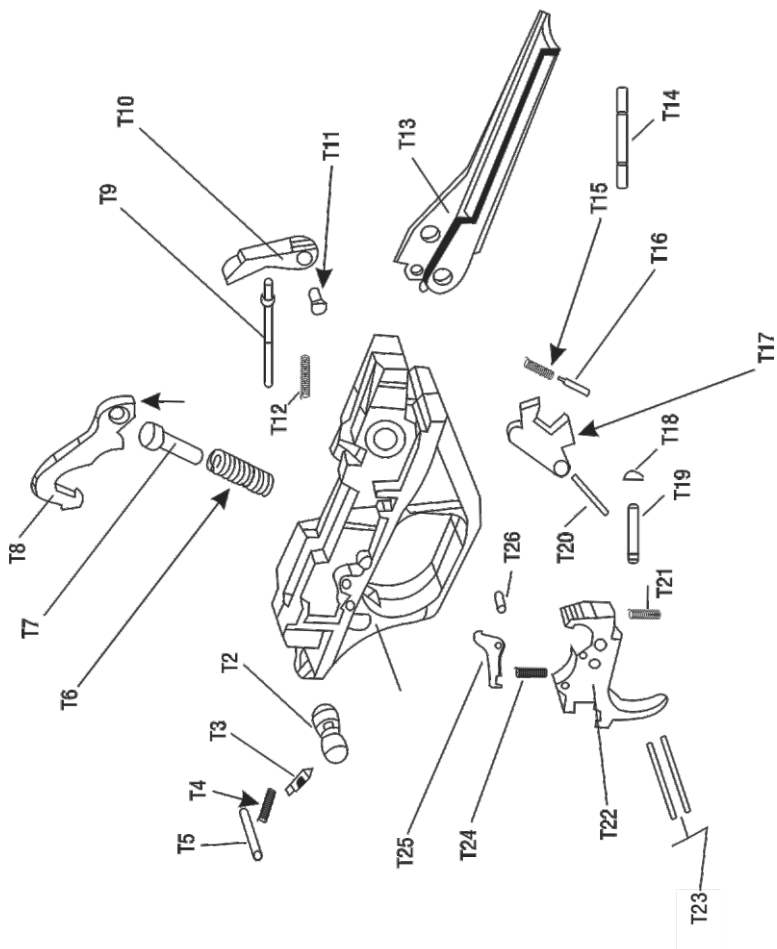





12 GA. TRIGGER GROUP ASSEMBLY - PART LIST

Stock No	Description
T1	TRIGGER GUARD
T2	SAFETY
T3	SAFETY SPRING PIN
T4	SAFETY SPRING
T5	SAFETY PIN
T6	HAMMER SPRING
T7	HAMMER SPRING TUBE
T8	HAMMER
T9	CARRIER LATCH PIN
T10	CARRIER LATCH
T11	CARRIER CONNECTION PIN
T12	CARRIER SPRING
T13	CARRIER
T14	RECEIVER CONNECTOR PIN
T15	CARTRIDGE DROPPER LATCH SPRING
T16	CARTRIDGE DROPPER LATCH PIN
T17	CARTRIDGE DROPPER
T18	HAMMER TUBE RING
T19	HAMMER TUBE HOUSING
T20	CARTRIDGE DROPPER RETAINING PIN
T21	TRIGGER FRONT SPRING
T22	TRIGGER
T23	TRIGGER PIN
T24	SEAR SPRING
T25	SEAR
T26	SEAR PIN

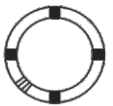
USAGE OF CHOKE TUBES

The choke is what controls the openness or tightness of the pattern of your shotgun. The chart below lists the choke available (from open to tight), and the corresponding marks that indicate the choke of your specific shotgun.

	SKEET	IC	M	IM	F	XF
CHOKE TUBE						
BBL'S	CL	****	***	**	*	XF

Never fire or run gun cleaning tools through a barrel that uses choke tubes without having a choke tube installed. The threads of the choke tube and the internal threads of the barrel should be cleaned after each use and before installation of the tube.

To install a tube, insert the tube into the barrel and tighten with your fingers. Once the tube is finger tightened, tighten with the appropriate choke-tube wrench until the tube is snug. **DO NOT over tighten or forcefully tighten with wrench.**

USAGE OF STEEL SHOT

The choke (bore constriction) in all modern shotguns has been established based on the pattern performance of shot shells loaded with lead shot. When using the steel shot shells, you will notice a different performance in pattern density versus the established lead shot pattern, because the steel shot is harder and lighter than lead shot.

You should be aware of the following differences and cautions:

Never shoot steel shot loads in a full choked barrel or full choke tubed barrel. To do so may cause the barrel to swell or rupture. In general, steel shot fired with a modified choke will produce the equivalent of a lead full choke pattern. This will be true of all steel shot sizes up to and including no. 2. The established improved cylinder chokes will produce the equivalent of a (lead) modified choke pattern.

All steel shot sized larger than no. 2, and including special sized such as -F-, "T", etc., should be used only with improved cylinder chokes. These steel shot sized, when used in improved cylinder chokes, will produce patterns equivalent to (lead) full choke patterns. The established cylinder choke or bore will produce the equivalent of a modified (lead) pattern.

INSTALLATION OF MAGAZINE PLUG

Some Countries and local hunting regulation may require that a shotgun be limited to a maximum shell capacity of three (3) rounds (1 in chamber and 2 in the magazine).

Your shotgun may be packed with a magazine plug for this purpose OR may come the limiter plug already in the magazine tube. Please follow the instruction below to install or uninstall.

Installation:

1. Remove the forend screw cap, the forend and the barrel.
2. At the threaded end of the magazine tube (where the forend screw cap fits) you will locate a black snap ring.
3. A large blade screw driver should be used to remove the snap ring.
CAUTION: The snap ring will be under pressure from the magazine spring. Do not remove the snap ring in a manner where the ring could fly out and strike you or anyone else causing injury, particularly to the eye.
4. Compress the magazine spring into the magazine tube, and insert the magazine plug (small end first). Push the magazine plug and insert the snap ring so the snap ring end is flush with the end of the tube.

MAINTENANCE AND CLEANING

Caution : Make sure the gun is UNLOADED and take help from an experienced person or gunsmith if you do not have self confidence of a true maintenance.

1. Make sure the broad, polished finely fitted mating surface of the breech block and receiver is especially clean and lightly oiled with high quality gun oil. Do not use silicone or lanolin.
2. Run an oil patch through the bore with a cleaning rod starting from the breech end. To prevent leading, use a cleaning solvent and brass brush to clean the bore periodically. Follow this cleaning with one or two clean oil patches. Important: If your gun is equipped with choke tubes, do not use a brass brush to clean the barrels without having a choke tube installed. Barrels that utilize choke tubes must also have the choke tubes removed to clean and oil the threads inside the barrel and the choke tubes themselves. This will protect the threads and prevent dirt build up that can cause tubes to become difficult to remove.
Do not over tighten choke tubes. Wipe all exposed metal surface with an oiled cloth before storing. Do not squirt or pour oil into the inside mechanism because it may hamper proper functioning. After extended periods of heavy use, your gun should be taken to a qualified gunsmith to have the action disassembled for professional cleaning and lubrication.
3. Care for your wood stock and forearm the same way you would a piece of furniture with the same finish.



12 GA SEMI AUTOMATIC SHOTGUN

MANUFACTURERS WARNING

This firearm is manufactured to operate properly with original parts as designed.

It is the duty of the owner to ensure that any replacement parts are correctly installed and that neither original or replacement parts are altered or modified. Assembling a firearm incorrectly or using modified parts can result in damage to the gun, injury or death to the user or others. Always have parts installed by a qualified gunsmith.

/// IMPORTANT NOTE: ALTERING OR MODIFYING PARTS AND/OR INTERNAL SAFETIES IS DANGEROUS AND WILL VOID THE WARRANTY. ///