

ATN X-Sight 4K BH Series ATN X-Sight 4K Pro Series

DAY & DAY/NIGHT RIFLE SCOPES



MANUAL

X-SIGHT 4K USER'S GUIDE



AMERICAN
TECHNOLOGIES
NETWORK
CORP.

TABLE OF CONTENTS

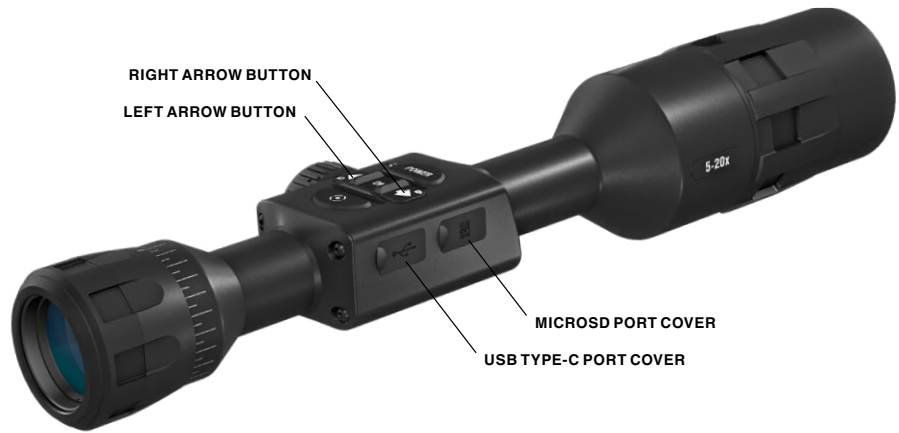
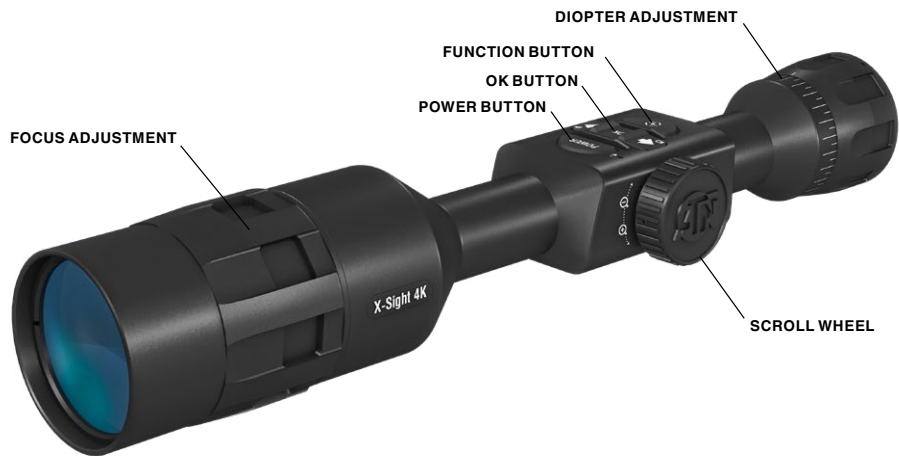

IR850
Infra-Red illuminator (included*)

















* Only with the X-Sight 4K Pro models.

CAUTION!
THIS PRODUCT CONTAINS NATURAL RUBBER LATEX WHICH MAY CAUSE ALLERGIC REACTIONS

The information in this manual is furnished for informational use only, is subject to change without notice, is not to be construed as a commitment by ATN Corp.
 ATN Corp. assumes no responsibility or liability for any errors or inaccuracies that may appear in this book.
 ©2021 ATN Corp. All right reserved.

- Features**4
- Application**4
- Specifications**5
- Preparing the Device**6
 - Unpacking6
 - Charging the Device6
 - Micro SD and USB C Ports6
 - Firmware Update7
 - ON/OFF8
 - Using your Keypad and Scroll Wheel8
 - Focusing8
 - Mounting9
 - ATN IR850 Infra-Red Illuminator9
 - Compass Calibration11
- Interface**12
 - Homescreen12
 - Main Operations13
 - Modes14
 - Shortcut Carousel14
 - Using System Settings15
- Functions**17
 - Night Vision17
 - Photo Mode18
 - Video Recording18
 - Recoil Activated Video19
 - Zeroing21
 - Rangefinder23
 - Ballistic Calculator25
 - Smart Mil Dot Reticle27
 - Reticle Style Adjustment28
- System Settings**29
 - Night Vision29
 - Photo/Video30
 - Display30
 - Profiles/Zero30
 - Settings31
- BIX Technology**32
 - ABL Pairing32
 - Laser Ballistics Pairing33
 - BinoX 4K/4T Pairing34
 - X-TRAC Pairing35
- Warnings and Cautions**35
- Mobile Applications**35
- 2 Year Product Warranty**36

FEATURES

-  RECORD HD VIDEO
-  DUAL STREAM VIDEO
-  BLUETOOTH
-  SMOOTH ZOOM
-  E-COMPASS
-  3D GYROSCOPE
-  DAY/NIGHT MODE*
-  SMART RANGE FINDER
-  BALLISTIC CALCULATOR
-  RECOIL ACTIVATED VIDEO (RAV)
-  ONE SHOT ZERO
-  PROFILE MANAGER
-  ULTRA LOW POWER CONSUMPTION
-  DUAL CORE PROCESSOR

* Only in X-Sight 4K Pro Series

APPLICATION

ATN has been at the forefront of your digital optic needs, and now we are surpassing all expectations by presenting a new series of products that delivers a profoundly new experience!

The X-Sight 4K Day/Night scope offers an enhanced HD Night Vision Mode, higher resolution and faster optics that allow for a faster image to form on the new HD Display. Our New 4K Sensor and Dual Core Processor gives you the power to Record Video and WiFi Stream at the same time!

You wanted longer lasting power capabilities? You got it! The X-Sight 4K scope includes a long lasting internal Lithium Ion Battery, allowing for up to 18 hours of power.

The X-Sight's new retro design allows you to use your traditional 30 mm mounting rings that will allow you to have plenty of eye relief while using the rifle you want.

Sighting your scope has never been easier with our One Shot Zero feature. Plus, a slew of other features, you have come to expect from the ATN Smart HD Optics line.

SPECIFICATIONS

Item	BH Series		Pro Series	
	X-Sight 4K BH 3-14x	X-Sight 4K BH 5-20x	X-Sight 4K Pro 3-14x	X-Sight 4K Pro 5-20x
Magnification	3 – 14x	5 – 20x	3 – 14x	5 – 20x
Field of view at 1000 yds	460 ft (9°)	240 ft (5°)	460 ft (9°)	240 ft (5°)
Sensor	ATN 4K M265 Sensor, 3864 (H) × 2218 (V)			
Core	ATN Obsidian IV Dual Core			
System Resolution	600 lp/mm			
Micro Display	1280x720 HD Display			
Eye relief	90 mm			
Video Recording Resolution	1080p @ 30/60/120 fps**			
Ballistic Calculator	Yes			
WiFi (Streaming, Gallery, & Controls)	iOS & Android			
Bluetooth	Yes			
3D Gyroscope	Yes			
3D Accelerometer	Yes			
E-Barometer	Yes			
Smart Range Finder	Yes			
RAV (Recoil Activated Video)	Yes			
Electronic Compass	Yes			
Smooth Zoom	Yes			
Reticles	Multiple Patterns & Color Options			
Microphone	Yes			
Micro SD card	4 to 64 Gb			
USB, type C	Yes			
Mount	30 mm Standard Rings (not included)		30 mm Standard Rings (included)	
IR Illuminator	Not included		Included	
Night Vision	No		Yes	
Battery life (Li-ion)	up to 18 hrs			
Battery type	Internal Lithium Ion Battery			
Waterproof rating / IP rating	Weather resistant			
Smart Mil Dot Hash Mark Value Range	1.0 – 10.0			
Dimensions (body only)	13.8"×3"×3" 350×76×76 mm	14.9"×3"×3" 379×76×76 mm	13.8"×3"×3" 350×76×76 mm	14.9"×3"×3" 379×76×76 mm
Weight	2.1 lb / 0.94 kg	2.2 lb / 1.01 kg	2.1 lb / 0.94 kg	2.2 lb / 1.01 kg
Warranty	2 years			

* ATN reserves the right to change the above specifications at any time without notice.

** When choosing to use this option, the incorporation of your wickets are absent. Wickets would include reticle, time stamp, and logo that are added during video processing.

PREPARING THE DEVICE

UNPACKING

The following steps must be performed before using the device.

1. Open packaging box, remove X-Sight 4K.
2. Verify your box has the following: Optic, Optic Cover, Sunshade, Rubber Eye Piece, IR Illuminator (only with X-Sight 4K Pro), Rings (only with X-Sight 4K Pro), Charging Cable.
3. Inspect the device for damage to optical surfaces, body, eyecups, operation buttons, etc.
4. Ensure that all optical surfaces are clean and ready for use.

NOTE

If any accessories are missing or broken contact ATN's Customer Service at 1.800.910.2862.

CHARGING THE DEVICE

The device is equipped with a USB (type C) port. You will find it under the rubber cap on the right side of the device (caps are marked with appropriate icon).

We have included a USB (type C) charging cable with your scope. Plug the cable into a USB wall charger that has an output of 2 amps (Wall Charger not included).

Charge your scope for 6 hrs using a 2 A USB wall charger. Note using a wall charger with lower amperage will take longer to charge your scope.

1. Recommended charger is 2 A USB charger.
2. Battery charging time (from 0 to 100%) is 6 hours with 2 A USB charger.
3. Battery run time is 18 hours on a single charge.

MICRO SD AND USB C PORTS

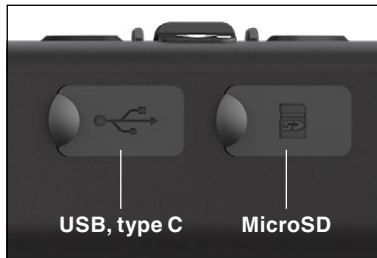

The device is equipped with a microSD Card and USB (type C) ports. You can find them under the rubber caps on the right side of the device (we marked the caps with appropriate icons).

To open the rubber port cover, gently lift the rubber cover and move it out of the way.

NOTE

Make sure that the device is turned off before inserting the formatted microSD Card into its assigned port.

1. Always format a new microSD card before using.
2. Insert microSD card as shown.
3. Use a thin object (small coin, paper clip) to lock the microSD card in place after inserting it into the slot.
4. Return the cover to its original position.



NOTE

There is only one correct direction to insert the microSD Card.

Do not force the microSD Card into the port doing so may cause damage to both the scope and the card itself.

To remove the microSD Card from the port, push the card slightly in using the same thin object you did before. When the card pops up a few millimeters, pull the card out with your fingers or tweezers.

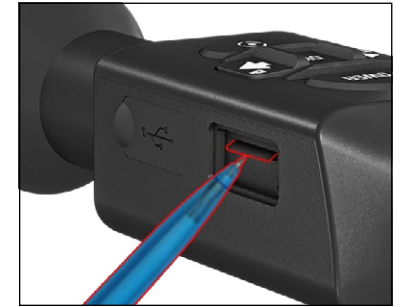

NOTE

If you are going to record video, the microSD Card should be a Class 10 (10 Mb/sec) or faster and have capacity from 4 to 64 Gb that is an HC type SD card.

FIRMWARE UPDATE

Before operating your device, update the firmware to the latest version. All firmware updates can be found on at <https://www.atncorp.com/firmware>.

To receive a notification concerning new firmware updates, please register your device on our website. An email notification will be sent when a new firmware update becomes available.

To update the firmware you will need a microSD Card and fully charged internal battery.

NOTE

In the event of a power failure during an update, the device may crash. This will corrupt the system files and the device will need to be sent back to the ATN factory for service.

To ensure your zero coordinates are not lost, write down your zero coordinates before continuing to update the firmware.

Update the new firmware as follows:

1. Download the *****.bin** file and copy to your microSD Card — root directory.
2. Insert the card into the scope.
3. Turn ON the scope.
4. In the “Firmware Update” dialog box select “Yes” to start the update.
5. When the update counter reaches “100%” the device will automatically restart.
6. Once the device is powered up it will enter self configuration mode.
7. After completing it will automatically restart.
8. Motion Sensing platform will be configured when first turned on.
9. Once the Firmware update completes, please do a factory reset before using the product.
10. Please delete the Firmware file off of the microSD card after the process is complete. Or the system will try to update the Firmware every time you turn the scope on.

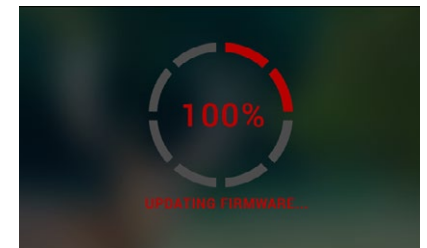

NOTE

If the device does not restart within 30 seconds, press and hold the power button for 15 seconds and the scope will turn off.

ON/OFF



To TURN ON the device, press and hold the POWER button until you see the ATN splash screen.

To TURN OFF the device, press and hold the POWER button, until “Shut down the device?” appears in the dialog box. Choose “Yes” to turn off.

If the scope freezes or stops responding to the control panel. Press and hold the Power button for 15 seconds to reboot the scope.

USING YOUR KEYPAD AND SCROLL WHEEL



The KEYPAD is programmed to be used in two different ways.

- Short and Quick Taps — used for most functions and to get around the menu.
- Press and Hold — designed to be used in the following situations — ON/OFF, SHORTCUT MENU.
- You can use the POWER and FUNCTION buttons in System Menu as UP and DOWN buttons.
- The Scroll Wheel is used to magnify your target from the Home Screen, or during the zero in process.

NOTE

Using LEFT or RIGHT buttons in the Menu. You can quickly choose Exit Shortcut from any position. Use the Function Button from any menu screen to exit to the Home Screen by pressing and holding down the Function button for a few seconds.

FOCUSING



DIOPTRER ADJUSTMENT

By rotating the Diopter Adjustment Ring you will achieve optimal sharpness for your vision. Look through the eyepiece while focusing on the reticle and widgets on the screen.

NOTE

Once the Diopter Adjustment is set to your liking, adjustment will not need to be performed unless another user altered the focus for their needs.

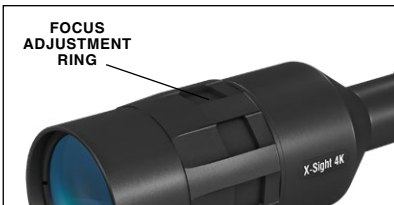

DISTANCE FOCUS

Rotate the Adjustment Ring, as necessary, to achieve the proper focus at various distances.

MOUNTING

The X-Sight 4K has a 3.5-inch eye relief, and can be mounted using 30 mm mounting rings. ATN has provided two standard rings and one L shape ring (For X-Sight 4K Pro only). The L shape ring is for those instances when you need extra eye relief for certain rifles. First, choose your preference of rings and position and mount the bottom portions of your rings to your rail for optimal eye relief. Place the scope on the bottom half of the rings you just mounted, verifying you have sufficient eye relief for your platform. Place the top portion of your ring over the mounted bottom portion, make sure the holes align and the screws turn easily. Apply equal torque to all screws with the provided Allen wrench. Make sure your rings are tight on your rifles rail and will not come loose due to recoil.

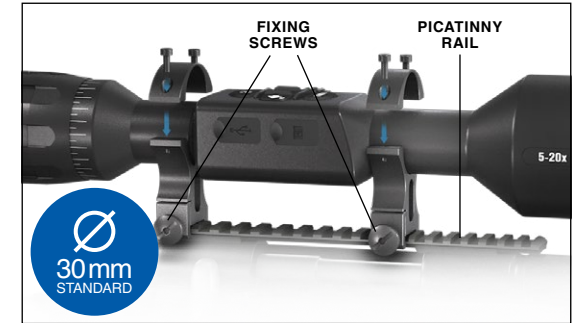

For mounting the X-Sight 4K on the Picatinny rail:

1. Loosen the fixing screws on the sides of the mounting rings.
2. Place the rifle scope on the Picatinny rail so that the projection of the rail, which is in the base of the ring, enters the recess in the rail.
3. Tighten the fixing screws of the mounting rings.

CAUTION!

Be sure your weapon is not loaded. Use safe weapon handling procedures at all times.

NOTE

Please do not over tighten the Fixing Screws when attaching the rings to your rail, we recommend using 30 in-lbs.

NOTE

Rings are only included with the X-Sight 4K Pro models only.

ATN IR850 INFRA-RED ILLUMINATOR

NOTE

The IR850 IR Illuminator is only included with the ATN X-Sight 4K Pro models. If you have the Buckhunter model skip this section.

BATTERY

NOTE

Please hold the battery tube (not the flashlight head or neck) when Tightening/loosening the tail-cap.

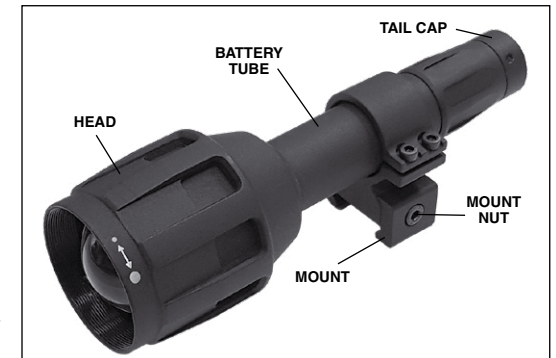

The IR850 IR Illuminator uses two CR123A batteries.

1. Remove the tail cap unscrewing it until it is free of the body.
2. Install the battery in the body, observing proper battery polarity.
3. Install the tail cap back on the body.

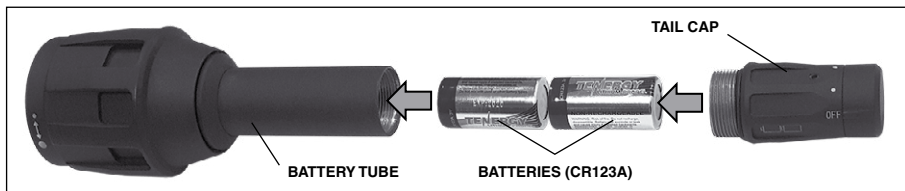

MODES

The IR850 has three stage output — Low, Medium and High system. Low at 5%, 20 h. Medium at 30%, 8 h. High at 100%, 1.6 h.

General Mode:

The factory preset modes control the brightness of the IR850 illuminator.

The three modes are designated on the tail cap that activates the modes. The modes are distinguishable by the size of the dot on the tail cap. The small dot indicates the lowest power output setting. The medium dot indicates the medium output power setting. The large dot indicates the strongest output power setting.

To activate the desired mode, turn the end of the tail cap, so that the dot indicator is aligned with the desired power output. This will turn on the required output for your needs.

To turn off the IR850 illuminator, simply turn the tail cap so that the dot indicator is positioned on the off setting.

FOCUS

Turn the light on maximum output and shine it on a wall 8~10 m away. To focus the beam, hold the head in one hand and turn the neck section with your other hand turn clockwise or counter-clockwise.

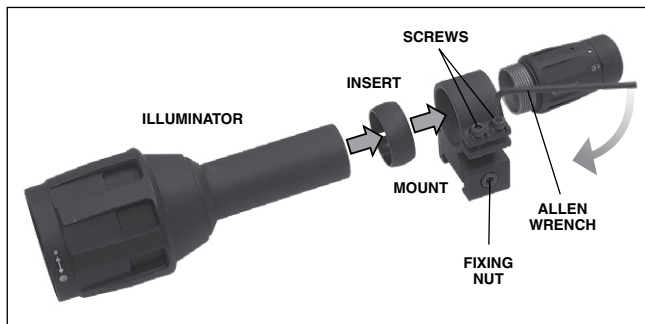

screws using an Allen wrench. Do not apply excessive torque.

ALIGNING THE IR BEAM

In order to Align the IR850 illuminator to your scope. After the IR850 is assembled into the mount. Place it on the X-Sight side accessory rail or on your rifles accessory picatinny rail. Once mounted securely, slightly loosen the two screws on top of the mounting ring.

While looking through the X-sight at night with night mode activated. Move the IR850 around in the mount until you see the IR light covering your entire field of view in the X-Sight view finder. Once you have adjusted your IR light to be aligned with your X-Sight FOV, gently tighten the two screws on top of the mounting ring with an Allen wrench.

MOUNT

Attach the IR850 to adjustable mount as follows:

1. Unscrew the two screws.
2. Place the insert in the mount.
3. Insert the illuminator into the mount with insert.
4. Secure the two

MAINTENANCE

To prevent wear and retain water-resistance it is a good idea to lubricate the threads and o-rings if they become dry.

TROUBLESHOOTING

Light dimming

- Battery may be faulty. Try another fully charged battery.

COMPASS CALIBRATION

When the compass needs to be calibrated the word “CAL” appears instead of the Compass Scale. To calibrate you should rotate the device on three axis as pictured on the right.

NOTE

After calibrating the device please remember that the compass will work best when holding the X-Sight parallel to the ground.

Other possible abbreviations:

- ERR — an error was detected;
- SMF — your device is under Strong Magnetic Field;
- UPD — your firmware needs to be updated.



INTERFACE

HOMESCREEN

The first screen you'll see after turning on the device is the Homescreen. It consists of Scales, Status Bar icons and different Information Widgets.

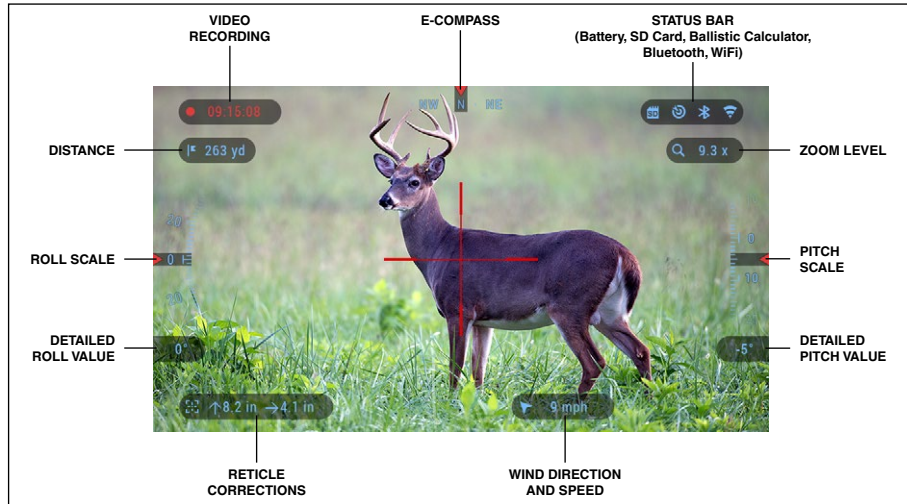

SCALES

- E-Compass Scale shows yaw angle, based on e-Magnetometer data.
- Roll Scale shows rifle cant, based on internal 3D Gyroscope.
- Pitch Scale shows rifle inclination, based on internal 3D Gyroscope.

STATUS BAR

Displays information about the current state of the system. Icons that are inactive become invisible when not in use, and only the important information will appear.

- Battery — shows how much energy is left in the system.
- Micro SD Card — shows the presence or absence (red icon) of memory card.
- Ballistic Calculator, Bluetooth, and WiFi — shows when the function is enabled.

WIDGETS

Interface elements will appear as widgets that will provide access to useful information. There are several types of widgets:

- icons without value are used for mode displaying (Photo and Video Modes);
- only numerical value (Detailed Roll and Pitch Values);
- icons with a numerical value: Range, Zoom, Reticle Correction, Wind Speed.

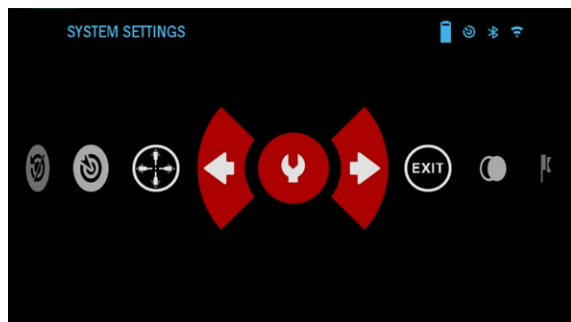





- Photo Preview appears at the bottom of the Homescreen, after the photo is taken.

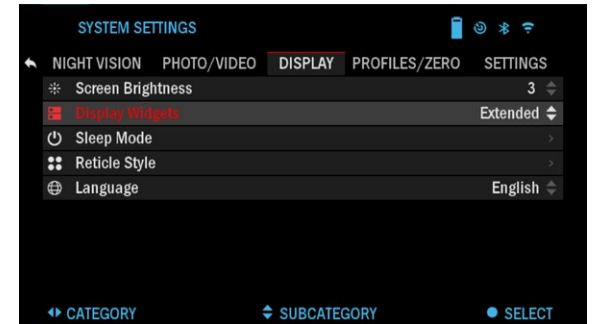

Display widgets can be disabled from the System Settings.

To enter System Settings you should click the OK button  from Homescreen to access the Shortcut Carousel.



Select the wrench icon with RIGHT or LEFT buttons  and push the OK button  to enter the System Settings menu.

Select the Display tab with RIGHT button  and choose subcategory Display Widgets with the Scroll Wheel or Keypad buttons .

Press the OK button  to select the Display Widgets. Use the Scroll Wheel or Keypad buttons  to change from Extended to Minimal.

MAIN OPERATIONS



Use the Scroll Wheel on the left side of the scope to Zoom IN and OUT. Zoom Level is displayed in the Zoom widget on the Homescreen.

NOTE

When the device is activated for the first time, you need to configure the lens option in the pop-up window before zooming. Please refer to System Settings→Settings→Device Type.



Press the LEFT button  to TAKE A PHOTO. One press of the button will result in one photo taken.



By pressing the RIGHT button  you will be able to RECORD VIDEO (if you use Normal Mode) or START RAV (if Recoil Activated Video mode is on). The video recording modes can be switched in the System Settings options.

NOTE

Recording will automatically stop when the memory card is full or the battery is out of power.



Pressing down on the OK button  opens and closes the Shortcut menu.

MODES

The X-Sight 4K Pro has 2 modes of operation: basic and advanced.

Basic Mode has the following feature options:

1. System Settings
2. Night Mode (X-Sight 4K Pro Models Only)
3. Advanced Shortcut
4. Zero Reticle

Advanced Mode has the following feature options:

1. Exit
2. System Settings
3. Night Mode (X-Sight 4K Pro Models Only)
4. Range Finder
5. Advanced Shortcut
6. Distance Entry
7. Environment
8. WiFi
9. Zero Reticle
10. Ballistic Calculator
11. Gallery

SHORTCUT CAROUSEL

The Carousel is your access to a number of shortcuts that will allow you to quickly access your scope's features. Click the OK button  from Home-screen to access the Carousel.

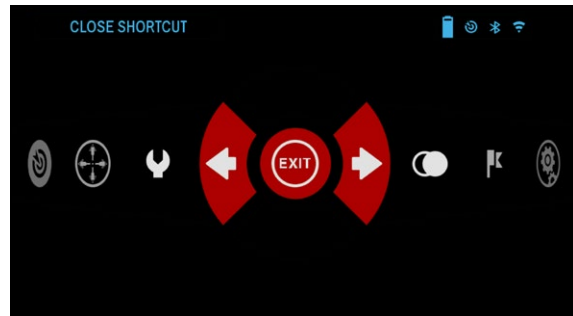

Buttons highlighted in Red are the only ones that activate a particular shortcut.

Use the LEFT & RIGHT buttons  to move between functions, except with the group of ON/OFF switches (WiFi, Bluetooth, Ballistic Calculator, RAV),

use the Scroll Wheel or Keypad buttons  between switches.

To turn a particular function ON or OFF, you should click the OK button  while that function is selected. Example – WiFi.



EXIT
Exit Carousel.



ONE SHOT ZERO
Sighting in your scope has never been easier with One Shot Zero. Take a shot adjust your reticle and you are good to go.



NIGHT MODE
Switch between Day and Night Mode.
Note: Night Vision Mode is only available on the X-Sight 4K Pro Series.



RANGEFINDER
Activates Smart Rangefinder feature. If the Ballistic Calculator is ON then the range that is found using the Rangefinder will be automatically used to adjust your point of impact (shift reticle to adjust for drop).



DISTANCE ENTRY
Manually input or adjust the distance to the target to be used by the Ballistic Calculator.



GALLERY
Gives you access to the library of Images and Videos that are stored on your scope's micro SD card.



ENVIRONMENT
Allows for input of various environmental data to improve ballistic correction, such as wind speed and direction.



SYSTEM SETTINGS
Allows access to various system options and adjustments.



WIFI
Allows you to connect to your smart phone or tablet; password is **atnsmarthd**.



BLUETOOTH
Allows you to connect to ATN Smart accessories, that use Bluetooth, to communicate with your scope.





BALLISTIC CALCULATOR
Allows you to have the scope automatically adjust your reticle POI for bullet drop, based on the ballistic information you input into the scope.

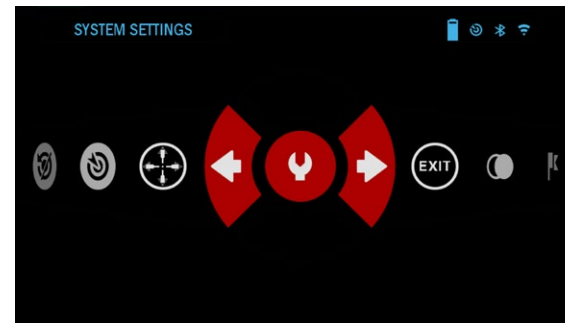

RAV (Recoil Activated Video)
Allows you to record your hunt without having to press the record button.

USING SYSTEM SETTINGS





To enter the System Settings, open the Shortcut Carousel by pressing the OK button . Select the wrench icon with RIGHT or LEFT buttons .

Push the OK button  to enter the menu.

The System Settings consists of a Tab Bar at the top of the screen, list of subcategories in the center and Help Information at the bottom.

On the left side of the Tab Bar you will find the Exit (with arrow icon). Selecting Exit and pressing the OK button  will bring you back to the Homescreen.

Movement between the tabs is carried out using the LEFT and RIGHT buttons .

Each tab includes subcategories. To select a particular subcategory you should use the Scroll Wheel or Keypad buttons  and press the OK button  to select it.

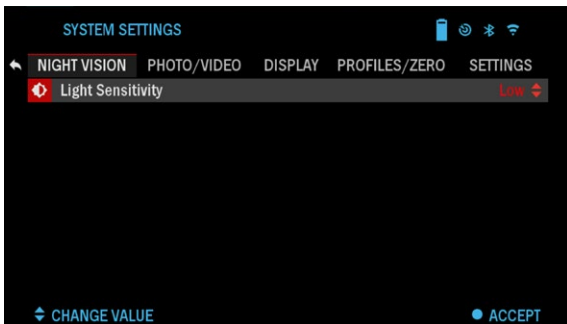
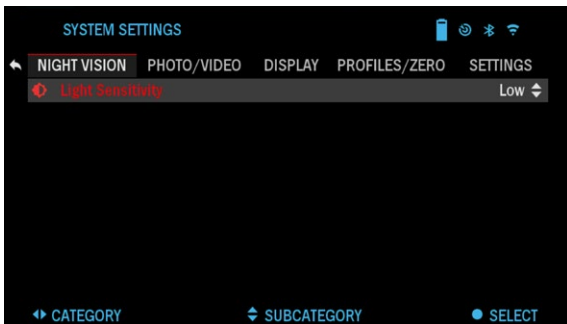
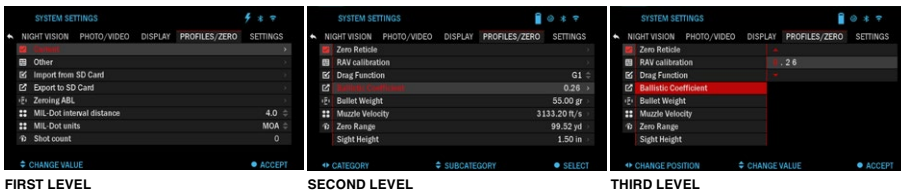
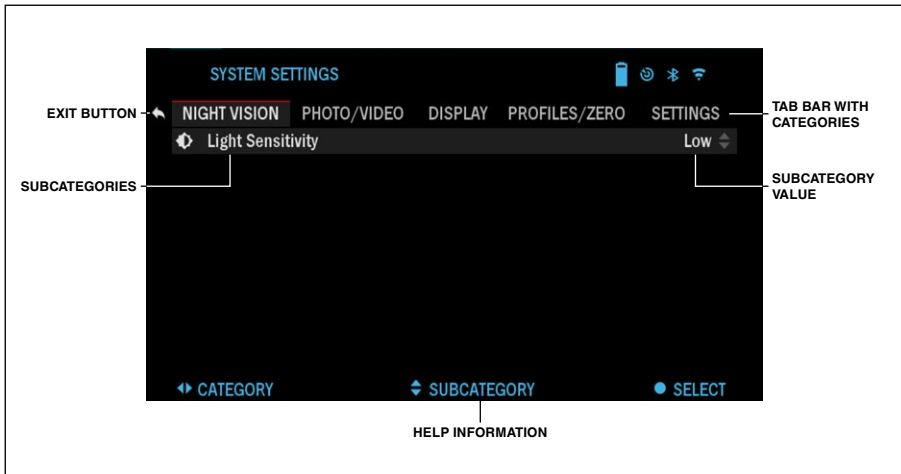

To select a new value, press OK button to confirm the change.

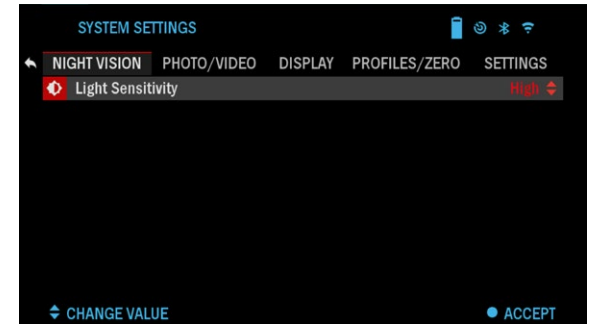

FUNCTIONS

NIGHT VISION

NOTE
Night Vision Mode is only available in the X-Sight 4K Pro Series.

To switch between Day and Night Mode, choose NIGHT MODE in Shortcuts.

Shortcuts allow you quick access to the Carousel that contains your scope's features. Just click the OK button to access the Carousel.



Buttons highlighted in Red are the only ones that activate a particular shortcut.

Movement between the items is carried out using the LEFT & RIGHT buttons .

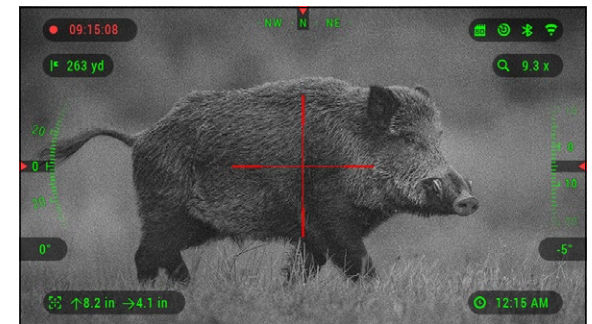
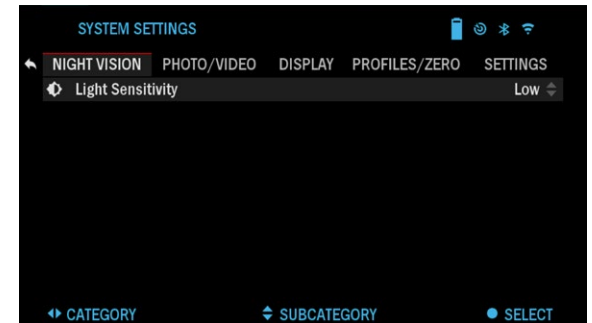
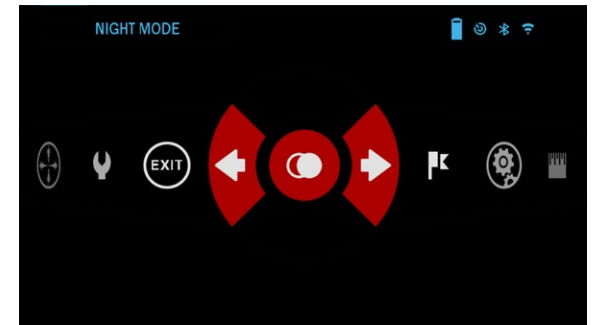
NOTE
Remember that turning on Night Mode during daylight will not harm your device; however, you may not be able to see anything due to the image being too bright.

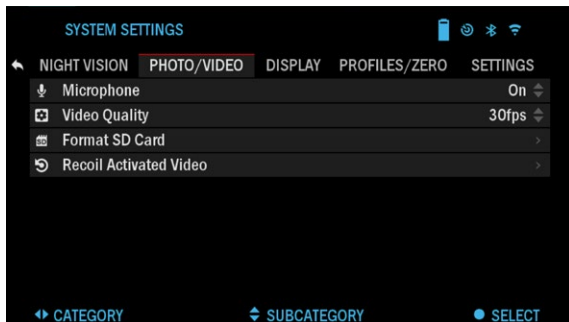



To enter the System Settings, open the Shortcut Carousel by clicking the OK button . Select the wrench icon with RIGHT or LEFT buttons .

Push the OK button  to enter the menu.

Choose Night Vision in the Tab Menu. Movement between the tabs is carried

out using the RIGHT or LEFT buttons .

NOTE

For the best video quality while recording in Night Vision mode. We suggest having your Light Sensitivity settings on Low.

PHOTO MODE

Press the LEFT button  while staying on the Homescreen to TAKE A PHOTO.

You must have a microSD card inserted in the device for this feature to work. All files will be stored on the microSD card.



PHOTOS

Allows you to take one photo at a time.

VIDEO RECORDING

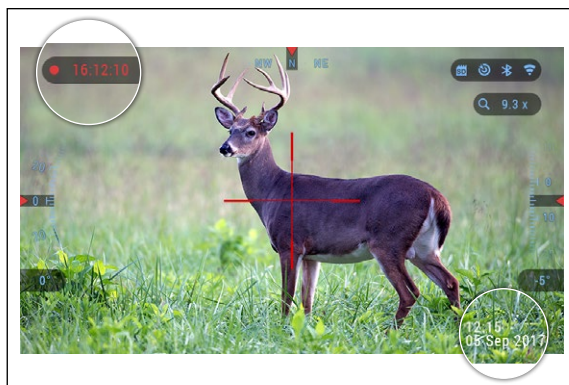

NOTE



You must have a microSD card inserted in the device for these features to work.

All files will be stored on the microSD card. Recorded videos can be found in the Gallery on your device.

The scope allows you to record videos in two modes.



NORMAL



The default mode. While recording the Counter widget appears. In order to Start recording video. While on the Homescreen, press the RIGHT button  to activate video recording. Press the RIGHT button  once more to Stop recording video.



RECOIL ACTIVATED VIDEO (RAV)

When you set your video record to RAV mode (from Shortcut Menu), the system buffers everything your scope sees.

While you are in this mode, the RAV widget appears and then after starting to record the Time Counter appears.

After activating the RAV function in the Shortcut Carousel, return to the Homescreen. Continue the activation process by pressing the RIGHT button  that activates Video. Also, make sure you see the RAV icon on the Home screen upper left corner. Press the RIGHT button  again to stop Video recording.

When a shot is fired and your scope experiences recoil (some airguns may not provide enough recoil for RAV to be activated). The scope will record video prior to the shot being taken, the moment of, and some time after. Exact settings may be adjusted in the System Settings.

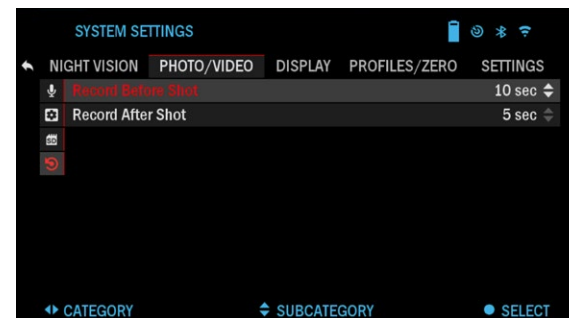



RECOIL ACTIVATED VIDEO

Recoil Activated Video (patent pending) offers a unique approach to taking videos with your Smart Sight. RAV offers you the ability to take a video of before, during and after your shot has been fired.

Perfect for those hunting moments when hitting your target, far outweighs the importance of remembering to turn on your video record. Simply set your RAV to ON, set your parameters. Anytime you Pull the Trigger, RAV is activated from the recoil of your weapon and the sight will record a number of seconds before your shot, and a number of seconds after.

All conveniently organized as one continuous video.

Press the RIGHT button  to Activate RAV from the Homescreen to Start Video recording. Press the RIGHT button  again to stop Video recording.

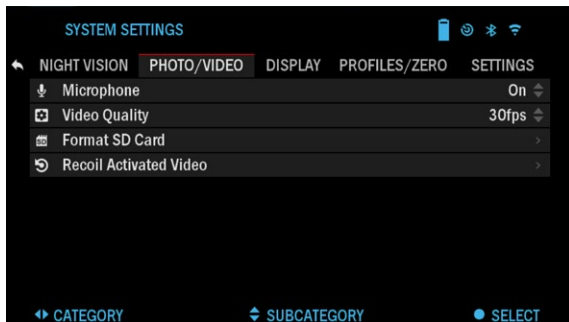

NOTE
It may be best to turn OFF the Microphone in conditions of extreme wind.

You can turn on the microphone and switch the quality of the video in the System Settings (Photo/Video tab).

To enter the System Settings:

1. Open Shortcut Carousel by pressing the OK button and select the wrench icon with RIGHT or LEFT buttons .
2. Push OK button to enter the menu.
3. Using the Scroll Wheel or Keypad buttons select Microphone. Press the OK button to select it.
4. Change the setting with the Scroll Wheel or Keypad buttons and press the OK button to confirm the change.

All files will be stored on the microSD card. Recorded videos can be found in the Gallery of the device.

RAV CALIBRATION

RAV (Recoil Activated Video) is a fantastic feature that allows you to set your scope to record your video when you fire your weapon. But as there are many types of calibers and platforms our standard RAV sensitivity may not be enough. IE small calibers that have little recoil, which fails to activate RAV. With this option you are able to adjust the sensitivity of your scope in order for it to recognize the light recoil and activate RAV.

NOTE

For best results you should only Calibrate RAV at a shooting range. ATN endorses safe and responsible recreational shooting, and does not recommend RAV calibration at home regardless of state law.

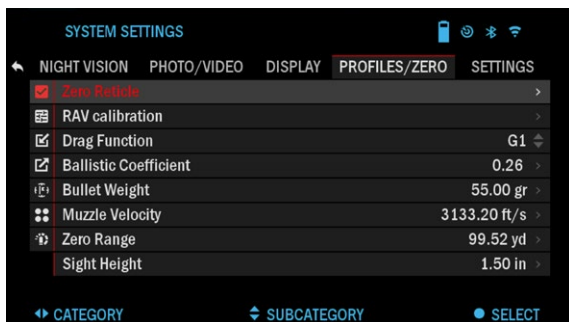

Open the Shortcut Carousel and navigate to Settings. Scroll to Profile/Zero and then select RAV calibration. You should see a velocity rating in the upper left corner (___ . ___ ft/s or m/s) followed by "1, 2, 3". The First circle is blinking denoting actively searching for input. While having the RAV calibration active fire a round down range.

You should see example (9.4 ft/s) or something similar, as it will depend on the caliber and your platform. Once you get the first number press the center OK

button to save. Repeat this process with only your desired input until there is a check mark on all numbers. If an error has been encountered either with ammunition, loading, or any other possible malfunction, simply press the left button to leave RAV calibration. Afterwards, please repeat the process.

Once this has been accomplished your scopes RAV is calibrated to your caliber, grain, velocity, and platforms felt recoil.

By following this process, you should be able to use RAV with the ammunition and platform used during the calibration process.

NOTE

We have conducted tests to 22 Air rifle and 22 Long Rifle successfully increasing the sensitivity of RAV.

ZEROING

NOTE

Before Zeroing your scope, please make sure the correct lens type is selected. You can check this by going to the System Settings and selecting Settings. You will see the subcategory Device Type. Please make sure you select the lens type of your scope.

This lets the system know which Scope you are actually using (example: X-Sight 4K 3-14 or 5-20).

To Zero in your scope you will need to go to the Profile/Zero section of the System Settings, or select it from the Shortcut Carousel.

To enter the System Settings, open Shortcut Carousel with OK button and select the wrench icon with RIGHT or LEFT buttons . Or select the Zero Reticle shortcut from the Shortcut Carousel.

Push the OK button to enter the menu.

Before you begin the Zeroing process you will need to either create a new Profile or utilize an existing one. We recommend to create a new one to understand the process better.

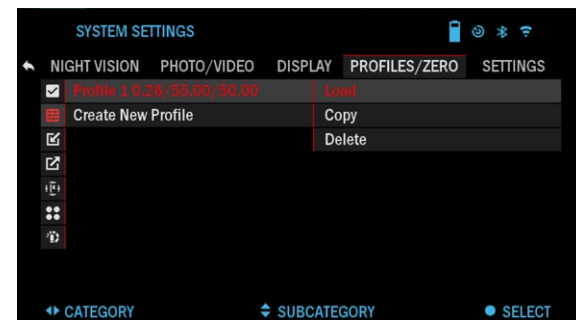
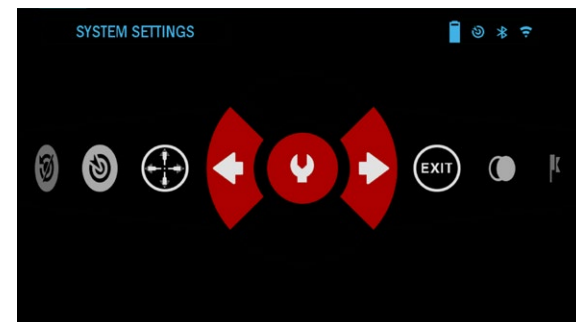
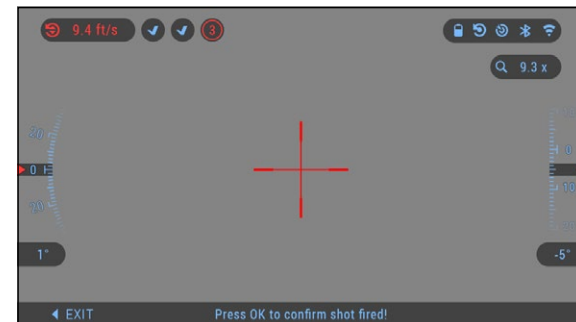

Under the Profiles/Zero Category you will find Current, Other, Import from SD card, Export to SD card. Select Other. There you will see Profile 1 and Create New Profile. You can select Profile 1 and edit it, or create a new one and make changes to it. Once you select a profile, press the OK button  to load it. Once the profile is loaded, it becomes your current profile.

Profiles are primarily used in order to utilize your scope on various weapons. This way, when moving your scope from one gun to the next, you can simply select the Profile that you have already created for the particular gun you are using. Multiple profiles are also used to zero in the scope, on the same gun, but at different ranges. For example, one Profile may be called AR 50 yards and another AR 200 yards.

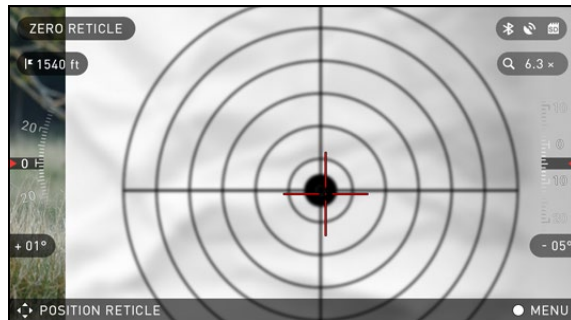
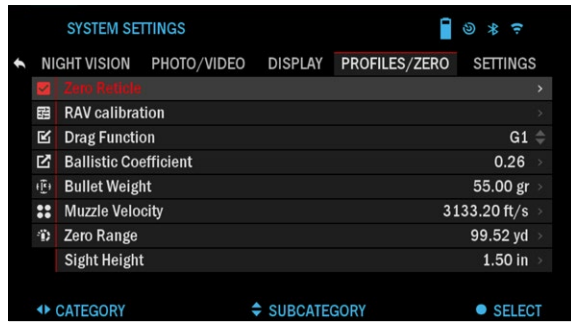
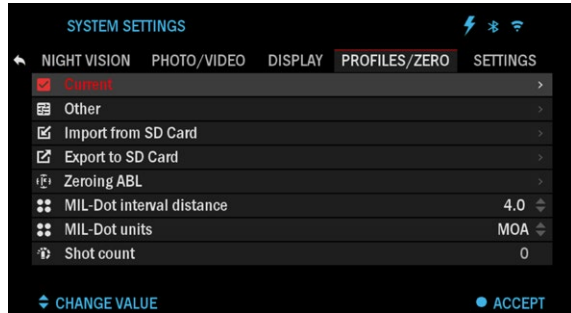

You will see on your screen a cross hair reticle. While keeping the gun as steady as possible, fire a round. Use the key pad and scroll wheel to move the Red cross hair to the point of impact. While keeping the White crosshair in the same place you where aiming. Once you have placed the Red crosshair on the POI, press the OK button . A dialogue box will appear with options. Select Save & Exit.

Allowing you to create two separate profiles to better fine tune your shooting solutions for both shorter and longer range shooting.

In order to change the profile name to what you want, open the ATN Obsidian app and connect your Phone/Tablet to your scope.

To zero your rifle with the ATN device, follow the next few steps.

Zeroing Scope:

In the System Settings, Select the Profiles/Zero Tab. The main Subcategories of the Profiles/Zero are Current, Other, Import from SD card and Export to SD card. Select Current, by pressing the OK button

. There you will see Zero Reticle. We suggest you fill out all the ballistic info, to the best of your ability, before proceeding to Zero. This will save you time when you want to use the Ballistic Calculator at a later time.

Proceed to Zero the Reticle. Press the OK button

 to select Zero Reticle.

NOTE

Although you may not need more than one shot to Zero in your scope, we do recommend that you repeat the process several times to make sure that you truly are Zeroed in. As you gain experience in Zeroing in your scope it should take you no time at all to Zero it.

NOTE

In order to fine tune your zero, select the Zero Reticle once more. Press the OK button  and select Zoom. Zoom in all the way and fire the weapon. If your POI is not where you aimed, move the Red reticle to the POI and Exit & Save. This will ensure your POI is the same on optical and maximum magnification.

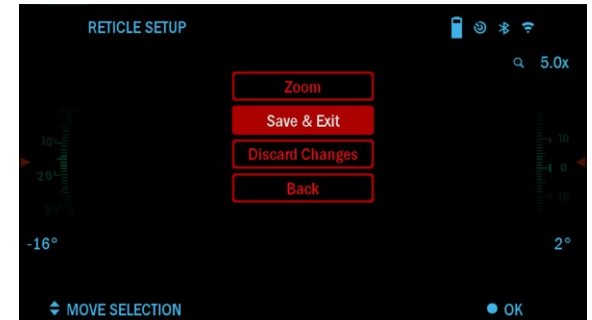

RANGEFINDER

Using the Smart Range Finder will allow you to estimate the distance to your target, as long as you have reasonable knowledge of the size of your target.

NOTE

To have this feature enabled you must activate Advance Mode settings.

NOTE

Once the distance is measured, the value will be automatically integrated into your Ballistic Calculator.



RANGEFINDER

Select the Flag Icon from the Shortcut Carousel.

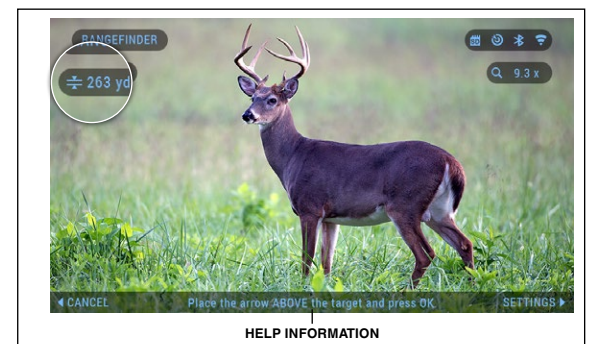
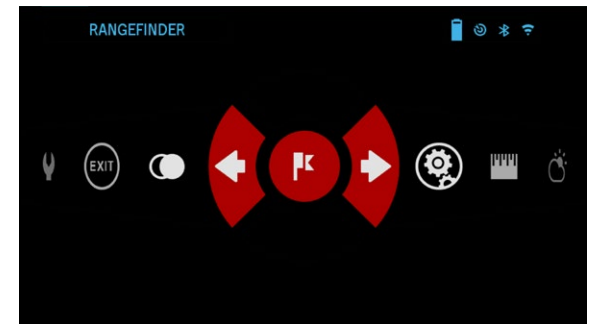
Pressing the OK button  will take you to the Main Screen of the Rangefinder feature.



To measure the distance, follow the next steps:

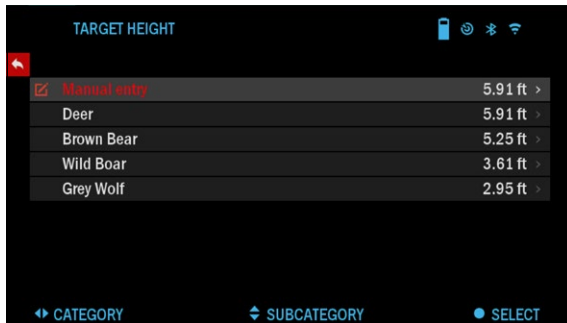
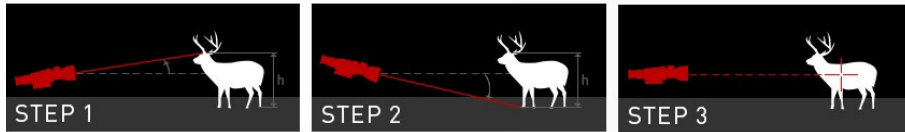

- put the arrow-mark on the top of the target and press the OK button ;
- wait for the scope to take the readings (it will take a number of readings so try to keep your weapon steady);
- put the arrow-mark under the target and press the OK button ;
- if satisfied with the value that was generated, press the Function button to go back to the Homescreen or repeat steps 1 and 2, if necessary.



NOTE



During the measurement process, you can zoom in and out using the Scroll Wheel.

If the Target Height is incorrect you can change it:

- press the RIGHT button  to enter the Menu;
- choose one of the presets or input the height manually;
- accept the height with OK button  and go back to the Main Screen.

DISTANCE ENTRY

Allows you to input or correct the distance manually. Choose the Distance Entry option to launch this function.

Change distance value using the Scroll Wheel or Keypad buttons . To accept the new distance, press the OK button .

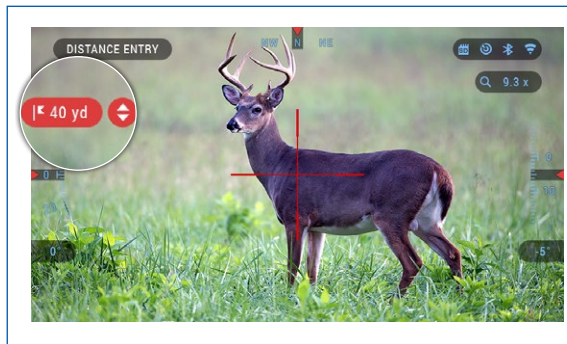
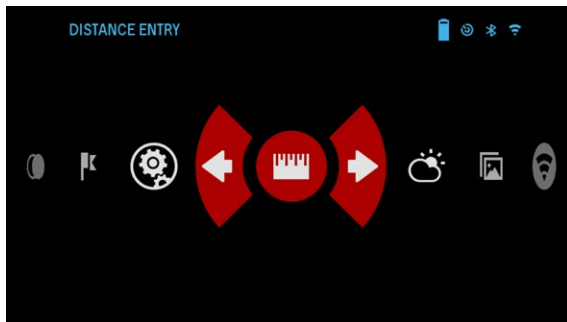

BALLISTIC CALCULATOR

The X-Sight 4K has a fully integrated Ballistics Calculator that enables your scope to seamlessly adjust its point of impact. The first step in utilizing this function requires you to enter all relevant information into the Profile that is being used.

NOTE

To have this feature enabled you must activate Advance Mode settings.

NOTE

If you do not know all or part of this info (example: Initial Velocity), we recommend that you contact the manufacturer of the ammunition and/or the weapon that you are using. Generally this info should be found on the manufacturer's website.

Once your profile has been setup, you are ready to activate the Ballistic Calculator on your sight. Open the Shortcut Carousel and follow the instructions in this section. 

You will need to use your key pad and Scroll Wheel or Keypad buttons , to find the Ballistic Calculator bullseye icon. If this function is off (indicated by a diagonal line running through the icon), you will need to turn it on by pressing the

OK button  while having the icon selected. You will see the diagonal line disappear and the Ballistic Calculator icon will appear in the top right corner of the screen.

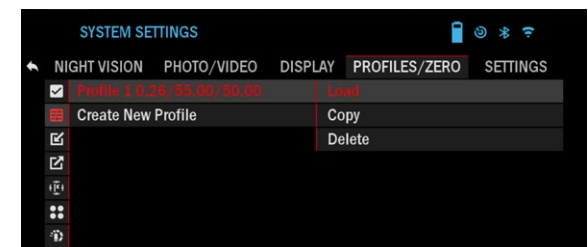
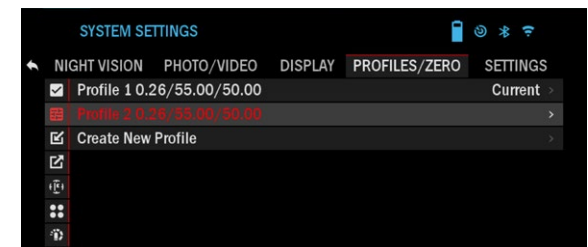
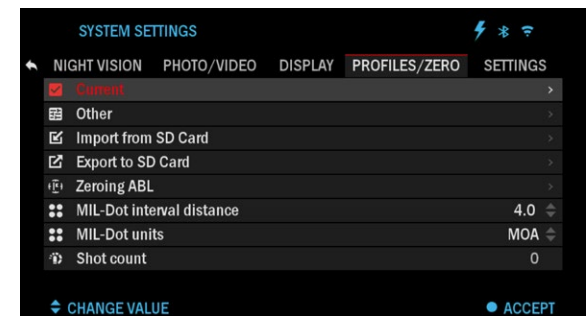
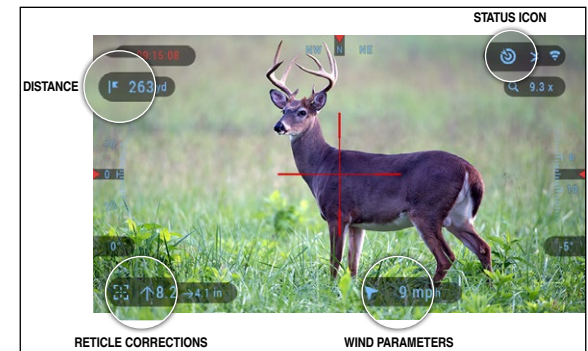
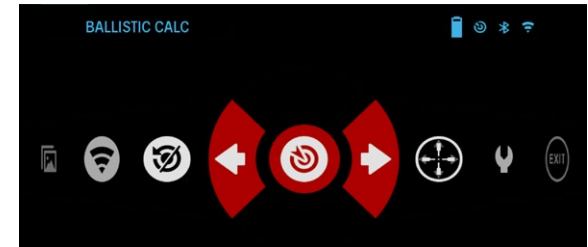

Profiles which are not in use are situated in the Other section. You can use an existing profile or create up to 6 new user profiles.

To edit a Profile, select it (highlighted in red) and press the OK button . Choose the action you want to perform; Load, Copy (Duplicate) or Delete the selected profile.

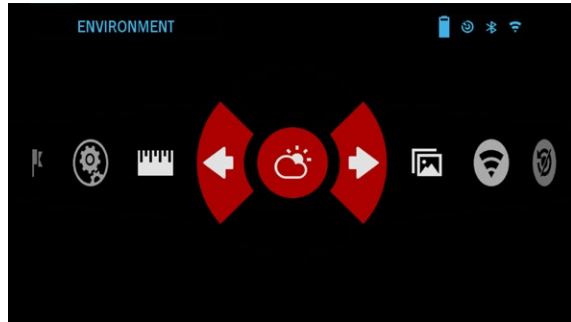

ENVIRONMENT

NOTE

To have this feature enabled you must activate advance mode settings.

There are a number of Environmental elements that may be entered to increase the precision of your shots.

Wind:

Wind strengths and direction are by far the most important of the group, especially during medium to heavy winds. We highly recommend that if you plan to shoot at ranges over 300 yards. Take wind readings and enter the information into your sight. Both wind speed and wind direction are needed if you plan to make accurate shots. You can enter the information through the Environment shortcut or your mobile device using the Obsidian App with a WiFi connection to your scope, whichever you find easier.

Humidity:

Humidity must also be entered through the Environment shortcut or by utilizing the Obsidian App.

Barometer Pressure, Altitude and Temperature:

Pressure, Altitude and Temperature need to be set manually in the environmental settings of your

scope, in order to provide the correct values to the internal sensors.

In order to better fine tune the environmental settings giving you full control over your ballistic shooting solution. In order to change the setting press the OK button to enter the Shortcut Carousel. Use your Left arrow button to scroll to the Environment Icon. Press the OK button to enter it. Scroll down using your down arrow to the environmental setting you want to adjust. Press the Right arrow to enter edit mode. Make the appropriate change and press the OK button to save the change.

NOTE

Barometric Pressure and Altitude data will reset when you restart the device on; the internal sensor re-calibrates on startup. As Barometric Pressure and Altitude may change the next time you turn the device on. We have made the internal sensor calibration readings as the default measurement every time you turn the device on. You will have to change these settings manually every time you want to use this feature, as it will revert to the sensor readings by default during system boot-up.

Other Data Collected:

The angle of your scope, as in relation to your target, is also noted and the Ballistic Calculator takes the information into its calculations.

RANGING IN ON YOUR TARGET

Clearly, the number one priority to achieve accuracy in long range shooting is to know the range to your target.

The Ballistic Calculator will make your adjustments for you, but only after you have entered the distance to your target.

Your sight offers several ways to accomplish this task.

SMART MIL-DOT-RETICLE

ATNs Smart Programmable Mil Dot reticle, depending on your load, you can program the variance between hash marks in Mils or MOA into this Smart Mil Dot Reticle. Also, this reticle is Dynamic and adjusts with magnification throughout the entire zoom range! Plus, you can also use the ATN Ballistic Calculator to give you instantaneous POI adjustments with a Teal dot, on the reticle, giving you exactly where to place your hold over. Happy Shooting!

There are two ways you can use the ATN Smart Mil Dot reticle. You can use it as a standalone Mil Dot reticle or you can have the ATN Ballistic Calculator assist you in its use.

In standalone form, the reticle will allow end users to have a verified distance between hash marks at all magnification levels.

Follow the next few steps to setup the Smart Mil Dot reticle.

1. Click OK center button .

2. Select System Settings.

3. Navigate to Profile/Zero.

4. Depending on which system you are using select the Mil or MOA option from the MIL-Dot units menu.

5. Select Mil-Dot-reticle value from the MIL-Dot interval distance menu, use your scroll wheel to set the desired value, and click OK button .

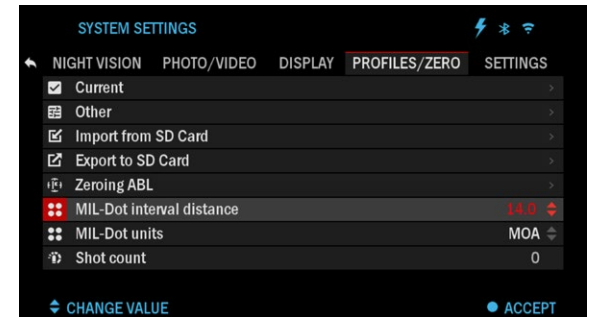
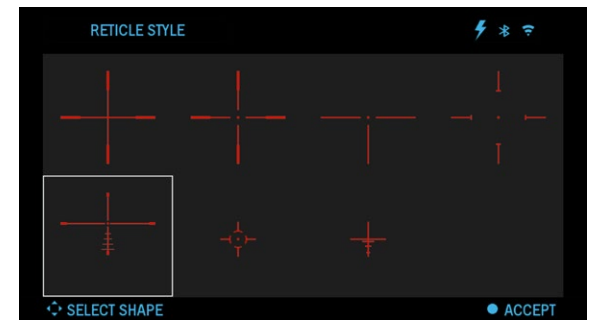
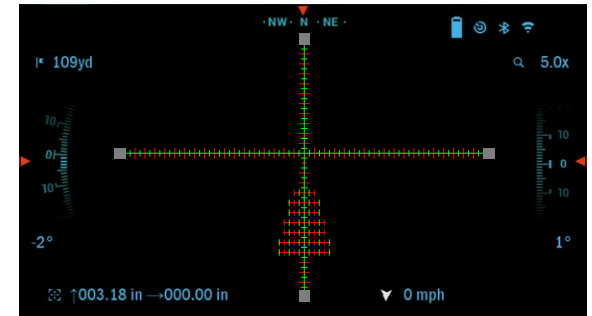

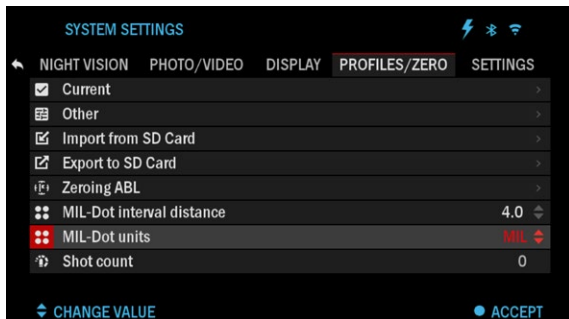

6. Scroll up to Current Profile and click OK (OK icon).
 7. Go to the Display Tab in system Settings and select the Mil-dot reticle. Return to Homescreen.

To use the ATN Smart Mil Dot Reticle with your Ballistic Calculator follow the setup process outlined in the Ballistic Calculator section, insuring that you

have the correct profile load setup, Ballistic Calculator is turned ON, environmental settings are correct, having the advanced settings activated. Once all of these items are setup properly and you have selected the Mil Dot reticle from the available reticles in the Display section of the settings. When you return to the Home Screen, you will see the ATN smart Mil Dot reticle with a Teal Dot indicating your new POI/POA instead of the reticle moving to the POI/POA.

NOTE

1 Mil = 10 cm @ 100 m. 1 MOA = 1 inch @ 100 y.

RETICLE STYLE ADJUSTMENT

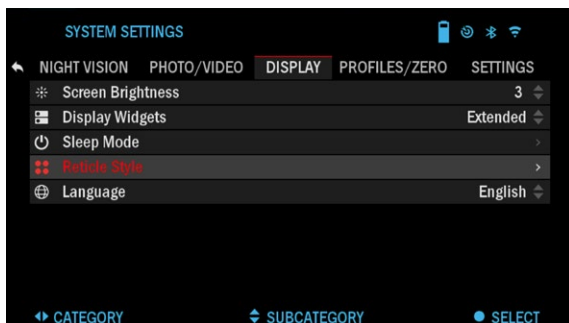

You can manage reticle style in the System Settings (Display section).

To enter the System Settings, open the Shortcut Carousel by pressing the OK button (OK icon) and selecting the wrench icon with RIGHT or LEFT buttons (RIGHT/LEFT icons).

Press the OK button (OK icon) to enter the menu.

Choose Display in the Tab Menu. Movement between the tabs is carried out using the LEFT and RIGHT buttons (LEFT/RIGHT icons).

Using the Scroll Wheel or Keypad buttons (Scroll Wheel/Keypad icons), select the Reticle Style subcategory. Press the OK button

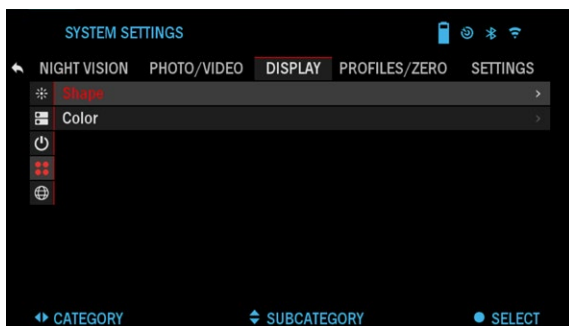

(OK icon) to select it.

To change the Reticle Shape press the OK button (OK icon).

Select the preferred Reticle style that suits your preference. Use the scopes Key Pad arrows to switch between shapes.

To accept the Reticle, press the OK button (OK icon).

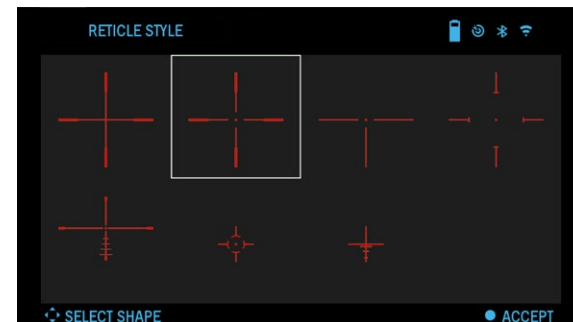

You can change Reticle Color to whatever color suits your preference.

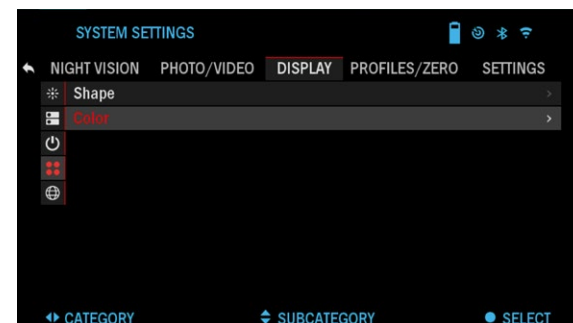

Movement between the colors is carried out using the LEFT and RIGHT buttons (LEFT/RIGHT icons). Press the OK button (OK icon) to accept your color.

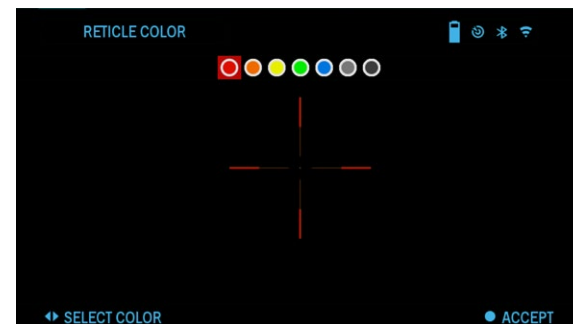

SYSTEM SETTINGS

NIGHT VISION

NOTE

Night Vision Mode is only available in the X-Sight 4K Pro Series.

LIGHT SENSITIVITY

There are two options for Light Sensitivity; Low or High. On the Low setting, you will get 30 fps. On the High setting, you will get 15 fps. Your selection will depend on the amount of ambient light needed for optimal performance.

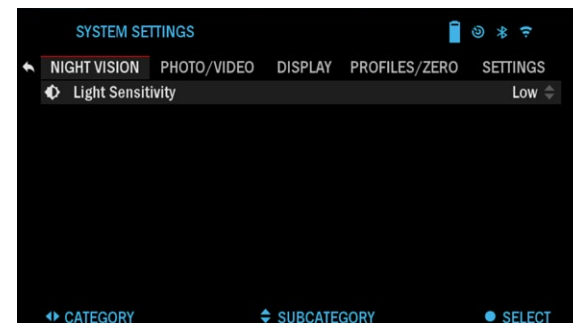

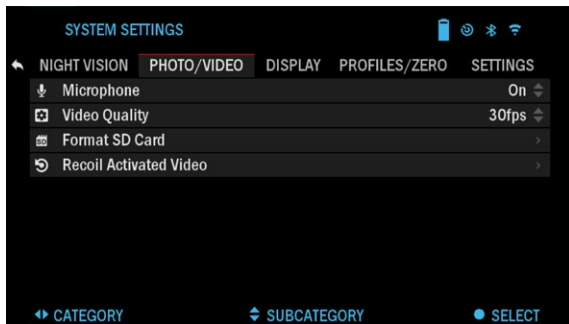

PHOTO/VIDEO

PHOTO MODE — includes Single (capture a single photo).

MICROPHONE — sound recording (ON/OFF).

VIDEO QUALITY — can be 1080p @ 30/60/120 fps*.

RECOIL ACTIVATED VIDEO

- Record Before Shot —

the time before pulling the trigger (5 – 30 sec).

- Record After Shot — the time after pulling the trigger (5 – 30 sec).

FORMAT SD CARD — after you choose this subcategory, you'll see a pop-up window asking you about formatting.

*NOTE

The ATN X-Sight 4K is capable of recording in day mode at 120 fps. This feature allows for postproduction editing for slow motion purposes.

Please note that the 120 fps mode is available in daytime setting only and it does not improve your image or quality. It should only be used if you plan on doing post production video editing.

When choosing to use this option, the incorporation of your widgets are absent. Widgets would include reticle, time stamp, and logo that are added during video processing.

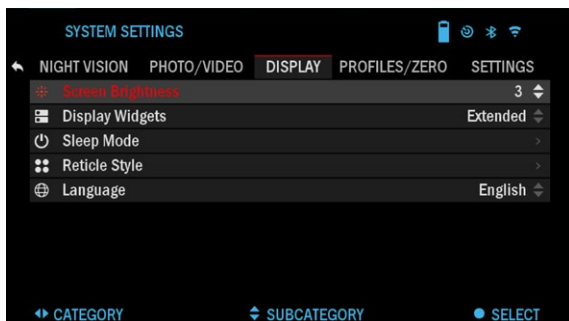

DISPLAY

SCREEN BRIGHTNESS

Gives you a 1 to 5 numerical selection, with 1 being the dimmest and 5 the brightest. It is recommended that you use the brightest setting during the day for optimal performance.

DISPLAY WIDGETS — allows you to disable several

widgets (Minimal/Extended).

SLEEP MODE

- Sleep Mode — allows you to switch the mode (ON/OFF).
- Hibernation Time — can be 1 – 60 min.

RETICLE STYLE

- Shape — you can choose the shape of your Reticle.
- Color — you can choose the color of your Reticle.

PROFILES/ZERO

CURRENT

- Zero Reticle — allows to enter zeroing mode.
- Drag Function — the flight path and characteristics of bullets divided into types (G1 – G8, GL).

- Ballistic Coefficient** — measure of bullet's ability to overcome air resistance in flight.
- Bullet Weight** — influences the kinetic energy of the bullet downrange.
- Muzzle Velocity** — is the velocity of the projectile as soon as it leaves the barrel.

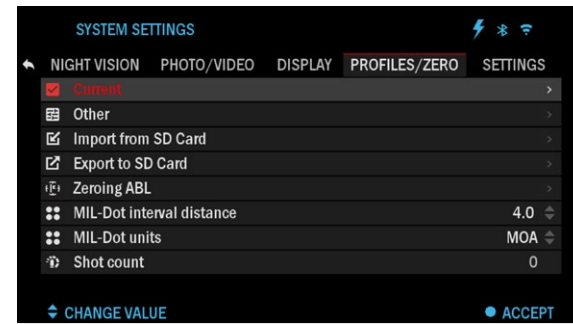

- Zero Range — is the range that a firearm is sighted at.
- Sight Height — is referring to the distance between the center of the optics and the center of the barrel.

OTHER

- Profile Name — list of existing profiles.
- Create New Profile — allows to create up to 6 profiles.

SETTINGS

UNITS — can be Metric or Standard system.

DATE AND TIME

- Clock Source** — allows you to choose different types of sources to improve the accuracy (Manual, WiFi).
 - Date Format** — can be YYYY-MM-DD, MM-DD-YYYY, DD-MM-YYYY.
 - Time Format** — form of stating the time (24-hour or 12-hour).
 - Date** — enter the date.
 - Time** — enter the time.
 - Time Zone** — allows you to choose a geographical region with standard time.
- WiFi AND BLUETOOTH** — WiFi values are not changeable.
- Remote controller** — Allows for pairing of X-Trac remote.
 - Remote Controller Orientation** — Allows you to choose the orientation of the remote, changing the direction of the scroll wheel.
 - Rangefinder** — Allows for pairing of the LBRF.
 - ABL** — Allows for pairing of the ABL Rangefinder.
 - ABL Mode** — Allows you to change the mode in which the ABL will function. Standard or Fog mode.
 - WiFi Info.**
 - BinoX LRF.**

DEVICE TYPE — to make all features work correctly you need to choose the type of lens you have. (Example: 3x stands for 3-14 and 5x stands for 5-20).

ZOOM — allows you to choose different types of zoom (Standard, Extended). Extended Zoom will give an electronic zoom of 10x your optical Zoom. Example: 3-14 in Extended mode becomes 3-30x. However, we would like to caution you that you will begin to see considerable pixelation at such a zoom.

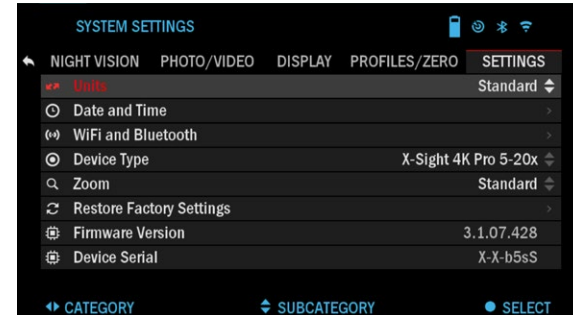

RESTORE FACTORY SETTINGS — allows to reset all the settings to default.

FIRMWARE VERSION — allows you to learn the firmware version currently running on your sight. We recommend that you register your product on our home page (www.atncorp.com) in order to make sure that you are getting emails when new firmware versions become available. We are constantly working on new features, functions, and improvements that we provide to you free of charge via firmware upgrades.

BIX TECHNOLOGY

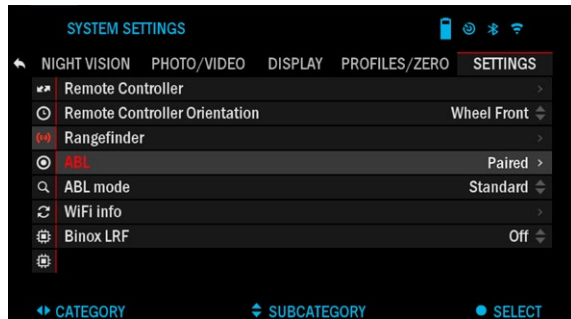
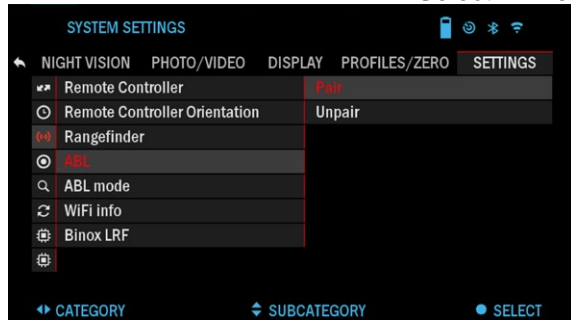
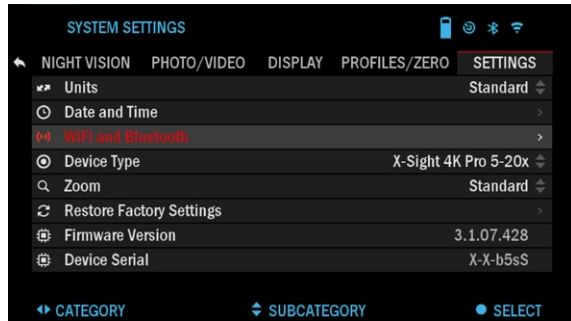

ABL PAIRING

NOTE

Make sure you have the Advanced Settings turned on in the Short-cut Carousel before proceeding.

- Insert battery into ABL and turn unit on via power switch.
- Activate Bluetooth within the carousel menu in the scope.
- Enter the System Settings menu via carousel Wrench icon.
- Navigate to settings menu at far right.
- Select WiFi and Bluetooth option.
- Select ABL option in the menu.

- Select pair from the ABL dropdown menu.
- You'll notice the Bluetooth icon, in the upper right of the display, you will now have a swirling circle around it. This indicates the scope is searching for available Bluetooth devices.
- Short press the small button on the ABL with the Bluetooth symbol, quickly 2 times.
- You'll now see that the Bluetooth icon in the upper right of the display is enveloped in a colored circle. White in day mode and yellow in night mode. After the pairing has completed, the ABL menu option will display "Paired", to the right.

- Exit the setting menu and proceed to the PROFILES/ZERO menu.
- Navigate down to the Zeroing ABL menu option and select it. The ABL reticle will now appear on screen.
- Having previously removed the Allen screw that covers the visible red laser, you can now move the ABL reticle to the correct area of the display to align the reticle with the infrared ranging laser. The visible red laser is used as a visual reference point for zeroing. Use the arrow keys on the keypad to move the reticle to the correct position.

- Once the box area of the ABL reticle is centered around the red laser, press the OK button  to confirm the reticle correction.

- Exit the menu and return to the Home-screen/Main reticle screen of the scope.



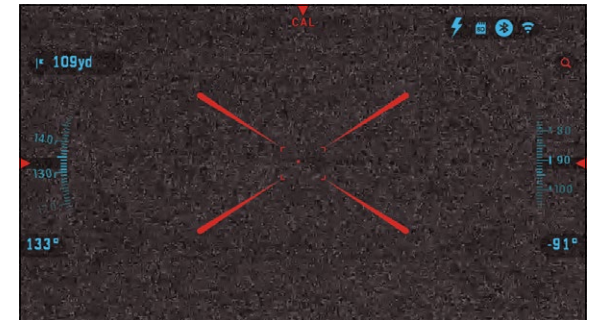
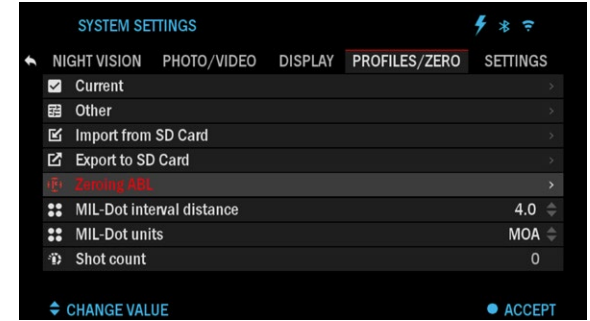

- To range a target, press and release the function button. The ABL reticle will instantly appear on screen. Place the box area of the ABL reticle on the desired target and hold it there until the ranging process times out. You'll now see the range in the upper left of your extended widgets has updated and indicates the correct range to the target you just ranged.









NOTE

If you don't want to wait for the ranging function to time out and need a quick range measurement press the function button to initiate ranging and press it once again to save the range to target.

LASER BALLISTICS PAIRING

- To do this you'll need to power up the scope and allow it to reach its base reticle screen (home screen).
- After reaching the home screen you'll next press the OK button  on the scopes keypad, which will bring up the carousel menu.
- Press the LEFT arrow button  until you reach the feature icon area of the menu (you'll notice the WiFi icon. WiFi will be written in text in the upper left of the display).
- Using the UP or DOWN arrow keys  on the keypad you will scroll until the BLUETOOTH icon is displayed in the center of the screen.
- Press the OK button  to un-slash the icon. This indicates the activation of BLUETOOTH.

- Use the UP or DOWN arrow keys  to scroll to the BALLISTIC calculator icon and use the OK button  to un-slash it. This will save time and steps later when the LBRF is connected to the scope and ready for use with the ballistic calculator program.
- Scroll to the SYSTEM SETTINGS icon in the carousel menu (indicated by a wrench in the center of the screen, and the text “SYSTEM SETTINGS” in the upper left of the display). Press the OK button  to access the SYSTEM SETTINGS MENU.
- Use the LEFT arrow key  to navigate to the SETTINGS section of the menu.
- Scroll down to the “WiFi and Bluetooth”. Select this option by hitting the OK button .
- A new menu will appear. Scroll down to “Rangefinder” and select this option using the OK button .
- A new menu will appear containing the options “Pair” and “Unpair”. Select the option to pair. This will activate Bluetooth searching, which searches for available Bluetooth devices. You’ll notice that the Bluetooth icon in the upper right of the scope’s display has a swirling circle around it indicating the search for the rangefinder.
- Next you’ll need the rangefinder in hand to press the power button on it. Press the power button on the rangefinder twice. This will sync the two devices. You’ll then see “Paired” to the right of “Rangefinder” in the menu. Now you can exit the menus and return to the home screen.

BINOX 4K/4T PAIRING

- If you would like to use your ATN BinoX 4K/4T to transmit the range data to your ATN Smart HD scope via Bluetooth, please follow the next few steps in order to accomplish this.
- Make sure you have activated the advanced settings in your BinoX 4K/4T.
- Open the shortcut Carousel → System Settings → Settings → WiFi & Bluetooth → Broadcast LRF.
- Select Broadcast LRF and switch it “ON”.
- Turn on your ATN Smart HD scope. Make sure you have activated the advanced settings in the shortcut Carousel.
- Open the shortcut Carousel → System Settings → Settings → WiFi & Bluetooth → BinoX LRF.
- Select BinoX 4K/4T LRF and switch it “ON”.
- Now take your ATN BinoX 4K/4T and Short Press the power button. You should see the Rangefinding reticule appear. Once the BinoX 4K/4T ranges the target, the range data will automatically be transferred to your ATN Smart HD scope. If you have the Ballistic Calculator turned on and the Ballistic profile has been setup, your POA will change based on the reading the ATN Smart HD scope receives from the ATN BinoX 4K/4T.

X-TRAC PAIRING

- Activate the Bluetooth function in your ATN Smart HD Scope.
- Enter the system setting from the menu.
- Select the Settings Category.
- Select the WiFi and Bluetooth subcategory.
- Select Remote Controller.
- Select Pair. You should see a half circle move around in the upper right side of the screen around the Bluetooth Icon.
- Press and hold the Home Button and Top Arrow Button closest to the Directional Roller for 2 seconds, this will pair the X-TRAC to your scope.

NOTE

If you need additional trouble shooting assistance or how to use the X-Trac please refer to the X-Trac manual available online.

WARNINGS AND CAUTIONS

- Always remember to turn off the device when it is not in use.
- Do not disassemble, drop, open, crush, bend, deform, puncture, shred, microwave, incinerate, paint or insert foreign objects: it will void your warranty.
- Keep the scope in the provided protective cover when not in use.
- Avoid contact with dust, steam, and gas.
- This product contains natural rubber latex which may cause allergic reactions.
- The scope is a precision electro-optical instrument and must be handled carefully.
- Do not scratch the external lens surfaces or touch them with your fingers.

CAUTION

Failure to follow these safety instructions could result in damage to the device!

MOBILE APPLICATIONS



Control your device and view a live streaming feed with our ATN Obsidian 4 app. After connecting your phone or tablet via WiFi to your ATN device, you can see on your phone/tablet screen what is shown in your optic’s viewfinder.



Want to see what you’ve recorded so far? No problem open up the Gallery and playback your latest adventures. All your photos and videos are right at your fingertips.

In order to download the latest version of the ATN Obsidian 4 app. Please visit the iOS store or Google Play store. Search for “ATN Obsidian 4” install the application.

To connect your ATN device to your smart phone or tablet, you must first enable WiFi on your ATN device via the shortcut carousel. Once enabled, you can access your WiFi settings on your phone or tablet and select the respective SSID (DeviceName_XXXX) to establish the connection. The default password is “atnsmarhd”.

Once the connection has been successfully established, open your ATN Obsidian 4 app and your respective device should be shown on the home screen. Tap the button with your devices name to control your device, access live streaming as well as the gallery from your phone or tablet.



[iOS Application](#)



[Android Application](#)

2 YEAR PRODUCT WARRANTY

This product is guaranteed to be free from manufacturing defects in material and workmanship under normal use for a period of 2 (two) years from the date of purchase. In the event a defect that is covered by the foregoing warranty occurs during the applicable period stated above, ATN, at its option, will either repair or replace the product, and such action on the part of ATN shall be the full extent of ATN’s liability, and the Customer’s sole and exclusive remedy. This warranty does not cover a product (a) used in other than its normal and customary manner; (b) subjected to misuse; (c) subjected to alterations, modifications or repairs by the Customer or by any party other than ATN without prior written consent of ATN; (d) special order or “close-out” merchandise or merchandise sold “as-is” by either ATN or the ATN dealer; or (e) merchandise that has been discontinued by the manufacturer and either parts or replacement units are not available due to reasons beyond the control of ATN. ATN shall not be responsible for any defects or damage that in ATN’s opinion is a result from the mishandling, abuse, misuse, improper storage or improper operation, including use in conjunction with equipment which is electrically or mechanically incompatible with or of inferior quality to the product, as well as failure to maintain the environmental conditions specified by the manufacturer. This warranty is extended only to the original purchaser. Any breach of this warranty shall be waived unless the customer notifies ATN at the address noted below within the applicable warranty period.

The customer understands and agrees that except for the foregoing warranty, no other warranties written or oral, statutory, expressed or implied, including any implied warranty of merchantability or fitness for a particular purpose, shall apply to the product. All such implied warranties are hereby and expressly disclaimed.

LIMITATION OF LIABILITY

ATN will not be liable for any claims, actions, suits, proceedings, costs, expenses, damages or liabilities arising out of the use of this product. Operation and use of the product are the sole responsibility of the Customer. ATN’s sole undertaking is limited to providing the products and services outlined herein in accordance with the terms and conditions of this Agreement. The provision of products sold and services performed by ATN to the Customer

shall not be interpreted, construed, or regarded, either expressly or implied, as being for the benefit of or creating any obligation toward any third party of legal entity outside ATN and the Customer; ATN’s obligations under this Agreement extend solely to the Customer. **ATN’s liability hereunder for damages, regardless of the form or action, shall not exceed the fees or other charges paid to ATN by the customer or customer’s dealer. ATN shall not, in any event, be liable for special, indirect, incidental, or consequential damages, including, but not limited to, lost income, lost revenue, or lost profit, whether such damages were foreseeable or not at the time of purchase, and whether or not such damages arise out of a breach of warranty, a breach of agreement, negligence, strict liability or any other theory of liability.**

PRODUCT WARRANTY REGISTRATION

In order to validate the warranty on your product, ATN must receive a completed Product Warranty Registration Card for each unit or complete warranty registration on our website at www.atncorp.com. Please complete the included form and immediately mail it to our Service Center: ATN Corporation, 2400 NW 95 Ave, Doral, FL 33172.

OBTAINING WARRANTY SERVICE

To obtain warranty service on your unit, End-user must notify ATN service department by calling **800-910-2862** or **650-989-5100** or via e-mail **service@atncorp.com** to receive a Return Merchandise Authorization number (RMA).

When returning please take or send the product, postage paid, with a copy of your sales receipt to our service center, ATN Corporation at the address noted above. All merchandise must be fully insured with the correct postage; ATN will not be responsible for improper postage or, missing or damaged merchandise during shipment.

When sending product back, please clearly mark the RMA# on the outside of the shipping box. Please include a letter that indicates your RMA#, Name, Return Address, reason for service return, Contact information such as valid telephone numbers and/or e-mail address and proof of purchases that will help us to establish the valid start date of the warranty. Product merchandise returns that do not have an RMA listed may be refused or a significant delay in processing may occur.

Estimated Warranty service time is 10-20 business days. End-user/customer is responsible for postage to ATN for warranty service. ATN will cover return postage/shipping to continental USA end-users/customers after warranty repair only if product is covered by aforementioned warranty. ATN will return product after warranty service by domestic UPS ground and/or domestic mail. Any other requested, required or international shipping method the postage/shipping fee will be the responsibility of the end-user/customer.



For customer service and technical support, please contact

American Technologies Network Corp.

2400 NW 95 Ave, Doral, FL 33172

phone: 800-910-2862, 650-989-5100

e-mail: service@atncorp.com

www.atncorp.com