

LAR-47 RIFLES
OPERATING & SAFETY INSTRUCTION MANUAL

⚠ WARNING - Read and understand this manual before handling the firearm. If you do not understand any part of this manual, contact Rock River Arms for assistance.

Revision Level	Changes	Date
Original Release		June 2014

CONTENTS

SAFETY	4	LUBRICATION	33
SAFETY ALERT SYMBOL AND SIGNAL WORDS ...	4	UPPER RECEIVER	33
IDENTIFICATION	10	LOWER RECEIVER	33
PARTS IDENTIFICATION	10	BOLT CARRIER GROUP	33
COLLAPSIBLE STOCK	11	ASSEMBLY	34
INSPECT FOR AMMUNITION	12	ASSEMBLE BOLT	34
AMMUNITION	14	INSTALL BOLT CARRIER	35
LOADING	15	ASSEMBLE UPPER AND LOWER	
FIRING	18	RECEIVER	36
MALFUNCTIONS	20	TROUBLESHOOTING	37
UNLOADING	23	PARTS	42
DISASSEMBLY	25	WARRANTY	48
SEPARATE UPPER AND LOWER RECEIVER	25		
DISASSEMBLE BOLT	27		
CLEANING	29		
CLEANING THE EXTERIOR	30		
CLEANING THE BARREL	30		
CLEANING THE CHAMBER	30		
CLEANING THE LOWER RECEIVER	31		
CLEANING THE UPPER RECEIVER	31		
CLEANING THE BOLT CARRIER GROUP ...	31		

You must read, understand, and follow all the instructions in this manual before loading, disassembling or using this firearm.

If you do not understand any part of this manual or you are unsure about the operation of your firearm, contact Rock River Arms at (866) 980-7625 or e-mail us at contacttech@rockriverarms.com before proceeding.

This manual provides instructions on the operation and maintenance of LAR-47 rifles made by Rock River Arms. You must read, understand and follow the instructions and safety warnings in this manual. The safety of yourself and those around you depends on your knowledge of your firearm and of the safety guidelines common to all firearms.

SAFETY ALERT SYMBOL AND SIGNAL WORDS

The safety information in this manual is denoted by the safety alert symbol: 

The level of risk is indicated by the following signal words:

 DANGER - Indicates a hazardous situation, which, if not avoided, will result in death or serious injury.

 WARNING - Indicates a hazardous situation, which, if not avoided, could result in death or serious injury.

 CAUTION - Indicates a hazardous situation, which, if not avoided, could result in minor or moderate injury.

NOTICE - Indicates a situation that could result in damage to the equipment or other property.

⚠ WARNING - You must follow all of the safety guidelines to ensure the safe use of your firearm. Failure to follow these basic firearm safety guidelines may result in an unintended discharge which could cause serious injury or death.

⚠ The safe use of your firearm is your responsibility. You must protect yourself and others against injury or death from misuse of a firearm.

⚠ Always treat every firearm as if it were loaded.

⚠ Do not drop your firearm, as it may discharge on impact.

⚠ Always point the firearm in a safe direction.

⚠ Always keep your finger off the trigger until ready to fire.

⚠ Always be sure of your target and what is beyond your target.

⚠ Never breach load ammunition through ejection port. Always feed ammunition from a magazine.

⚠ Firearms must be unloaded when not in use. Load your firearm only when you are in the field or target range and ready to fire. Never let a loaded firearm out of your sight. Never climb a tree or cross obstacles such as streams, creeks or fences with a loaded firearm. Completely unload firearm as soon as you are finished shooting. Unload firearm before storing it, traveling, laying it down or entering a vehicle or building. Always verify that a firearm is unloaded. Do not take

anyone's word that a firearm is unloaded. Never pass your firearm to another person until both you and the other person have visually checked that it is unloaded. Keep your firearm unloaded and safely stored when not in use.

⚠ Never rely on your firearm mechanical features alone. Only your safe handling of your firearm will ensure the safe use of your firearm. A mechanical safety is not a substitute for common sense.

⚠ Before using a stored firearm, verify the firearm is completely unloaded, and check the barrel for any obstructions, debris, or excess oil. Never allow water, snow, mud or other materials to enter the barrel. Excess lubricants or grease can dangerously increase pressure and may cause barrel to burst when firing. If barrel is obstructed, remove ammunition and clean barrel immediately.

⚠ Use only the correct caliber and cartridge for your firearm. Never use incorrect ammunition. Never use remanufactured or reloaded ammunition. Use only quality undamaged ammunition in your firearm. Always read and follow the instructions on the ammunition box. Do not use the firearm if you have any doubt as to the caliber or cartridge the firearm is designed to use.

⚠ Safely store and secure your firearm and ammunition separately.

⚠ Be sure of your target and the surrounding area. Never fire unless you know exactly where your shot is going and what it will strike. Make sure the shot has a safe back stop, such as a hillside or sand. Bullets can ricochet on surfaces such as water and frozen ground. Do not fire into the sky.

⚠ Always wear appropriate eye and ear protection while firing a firearm. Be sure others in the vicinity have protection. Persons without eye and hearing protection must be 10 yards or more behind the firearm when it is fired.



⚠ Obey all laws regarding the storage, security, transportation and carrying of firearms. You must be familiar with all local, state, and federal laws regarding the safe use, storage and/or transportation of your firearm. Your local police department can answer any questions you may have regarding the legal use, storing and/or transporting of your firearm.

⚠ Discharging firearms in poorly ventilated areas, cleaning the firearm and handling ammunition may result in exposure to lead and other substances known to cause birth defects, reproductive harm, cancer, and other serious physical injury. Wash hands thoroughly after exposure. Read the warnings and labels of all ammunition and cleaning products carefully.

⚠ In the event of a misfire or hang-fire, leave the bolt closed, remove the magazine and wait 15 minutes with the barrel pointing in a safe direction. Keep your face away from the breach and put the safety on. This way you won't be hurt by a round possibly "cooking-off" (i.e. the round detonating just from the heat of the barrel). In any event, keep your face away from the ejection port while clearing a hot chamber. See *Malfunctions on page 20*. Unload your firearm and dispose of the ammunition safely. If the bullet has become lodged in the barrel, remove the bullet with a cleaning rod. Do not attempt to fire another round to dislodge the bullet.

⚠ Be sure all accessories are compatible with your firearm. Accessories must not interfere with the safe operation of your firearm.

⚠ This manual must accompany this firearm and be transferred with it upon change of ownership or when presented to another person.

⚠ Never use drugs or alcohol before or during use of a firearm. Never use a firearm if you are taking any medication which impairs your mental or physical ability.

⚠ Never alter or modify your firearm. Never disassemble your firearm beyond what is outlined in this manual. Improper manipulation of any internal components and/or improper disassembly or reassembly may be dangerous, and may lead to serious injury or death. Do not try to change your firearm's trigger pull, as alterations might cause accidental firing. Have a qualified, experienced gunsmith service, repair or upgrade your firearm.

⚠ Understand all operational aspects of the firearm before handling. Every firearm is different. Before using the firearm, read and follow this manual. Familiarize yourself with all mechanical features of your firearm. If you do not understand any part of this manual or have any questions about the safe operation of your firearm, contact Rock River Arms at (866) 980-7625 or e-mail us at contacttech@rockriverarms.com

Rock River Arms is not responsible for any physical injury or death, property damage, or damage to a firearm resulting in whole or in part from:

- Intentional or negligent discharge or firing of the firearm.
- Improper or careless use or handling of the firearm.
- Unauthorized modifications or repairs to the firearm.
- Defective, improper, remanufactured or reloaded ammunition.
- Neglect of the firearm or other causes beyond the control of the company.

⚠ If your firearm stops firing with a live round in the chamber of a hot barrel (misfire), remove the round quickly. However, if you cannot remove it within 10 seconds, remove the magazine and wait 15 minutes with the barrel pointing in a safe direction. This way you won't be hurt by a round possibly "cooking-off" (i.e. the round detonating just from the heat of the barrel). In any event, keep your face away from the ejection port while clearing a hot chamber. See *Malfunctions on page 20*.

IDENTIFICATION

PARTS IDENTIFICATION

- A - Flash Hider
- B - Handguard
- C - Magazine
- D - Charging Handle
- E - Buttstock
- F - Safety Selector
- G - Grip
- H - Trigger
- I - Magazine Latch
- J - Spent Case Deflector
- K - Forward Assist Assembly
- L - Ejection Port Cover

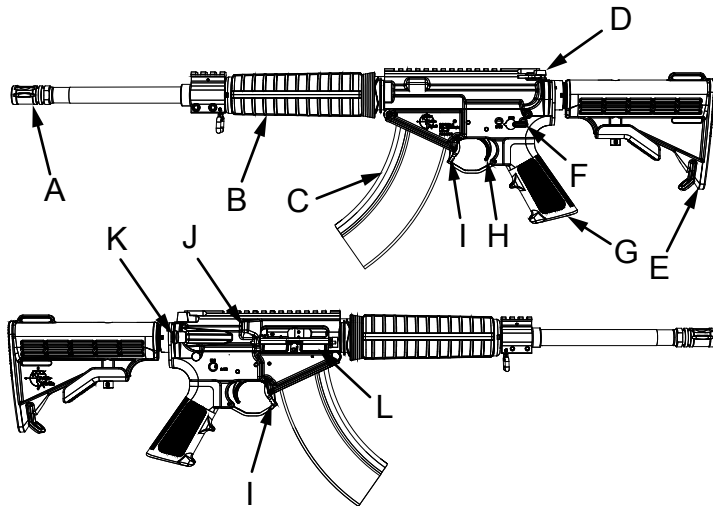

Go to our website at www.rockriverarms.com for technical information on specific components and accessories.

COLLAPSIBLE STOCK

⚠ WARNING - Risk of serious injury or death. A loaded firearm may discharge unintentionally. Point the firearm in a safe direction before adjusting stock.

1. Place safety selector on SAFE.
2. Point firearm in a safe direction.
3. The stock can be set to one of six positions. Squeeze latch (A) and move stock in or out to desired position and release latch (A). Verify latch is engaged in a detent. You may need to move stock slightly to engage in a detent.

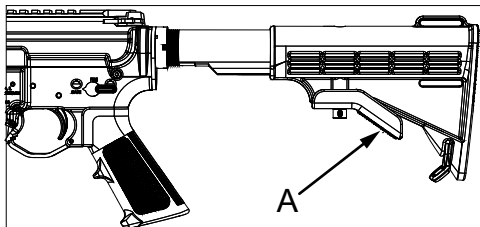

INSPECT FOR AMMUNITION

⚠ WARNING - Risk of serious injury or death. A loaded firearm may discharge unintentionally. Point the firearm in a safe direction while inspecting for ammunition.

1. Place safety selector (A) on SAFE.

Note: If hammer is not cocked, safety selector can not be placed on SAFE.

2. Grasp the firearm while keeping your finger off the trigger. Push magazine latch (B) forward, rock magazine forward and pull downward to remove magazine (C).
3. Pull charging handle (D) rearward.

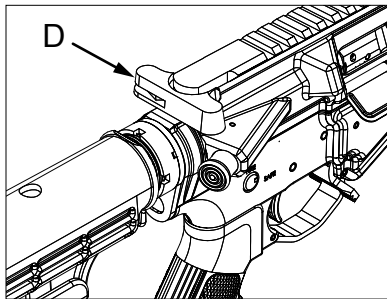
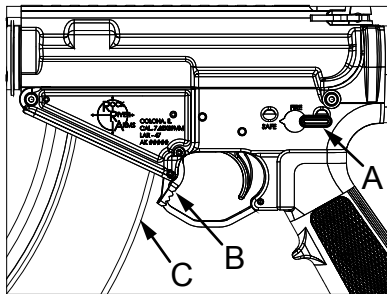

INSPECT FOR AMMUNITION

4. While holding charging handle back, look into the receiver and verify that there is no ammunition in the chamber (E). With safety selector pointing toward SAFE, release charging handle, allowing bolt to go forward.
5. Follow this inspection procedure before cleaning, before storage, before transporting, before handing to another person or when handed to you.

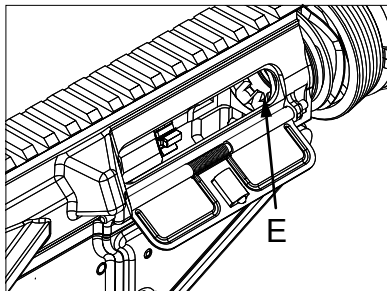

AMMUNITION

⚠ DANGER - Risk of serious injury or death. Failure to use the proper gauge or caliber of ammunition will cause your firearm to fail when firing. Always use ammunition specifically designed for use in your firearm.

⚠ You are responsible for using ammunition that is specifically designed for your firearm and that meets industry standards for use in your firearm. Never mix ammunition. Use only 7.62 x 39 mm ammunition in the LAR-47.

⚠ Using ammunition not specifically designed for your firearm can cause the pressure to exceed the capability of your firearm, and could damage and/or rupture your firearm.

Locate the caliber mark (A) on the firearm. This designates the ammunition caliber that must be used in your firearm.

⚠ Verify the caliber/chamber of the rifle's upper half. Caliber/chamber may be different than that specified on lower receiver.

Always inspect your ammunition before loading it. Never use damaged or corroded ammunition which could lead to a burst cartridge causing damage to the firearm and possible personal injury or death.

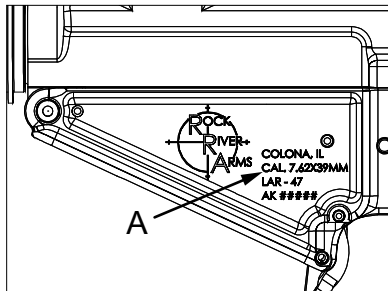

Use only factory-new 7.62x39mm ammunition in the RRA LAR-47. Please note that steel-cased ammunition may be more problematical than brass-cased ammunition, and should be considered to be corrosive regardless of what the packaging materials may indicate. Clean the carbine immediately after use.

LOADING

⚠ WARNING - Risk of serious injury or death. Always point the barrel of your firearm in a safe direction when loading or unloading.

Clean your firearm before the first use. Your firearm has been treated at the factory to prevent corrosion. The chamber, bore, and exterior surfaces must be cleaned to remove excess oil.

⚠ Load your firearm only when you are in the field or target range, when you are sure of the target and ready to fire.

1. Inspect the firearm for ammunition if you have not done so. **See *Inspect For Ammunition* on page 12.**
2. Verify that the safety selector (A) is in the SAFE position.

Note: If hammer is not cocked, safety selector can not be placed on SAFE.

3. Verify the bolt is fully forward and locked.

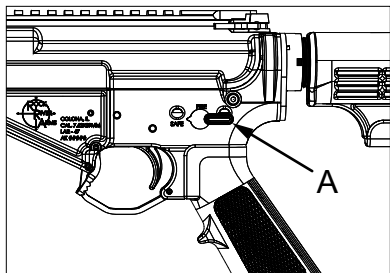

⚠ WARNING - Risk of serious injury or death. Using damaged, incorrect, non-standard, or handloaded ammunition may result in firearm failure or misfire. Use only quality undamaged ammunition in your firearm.

4. Inspect each cartridge for signs of damage. Do not load damaged ammunition. Load the magazine with the proper caliber (7.62x39 mm) of undamaged ammunition.

LOADING

5. Insert magazine into magazine well so that front tab on magazine hooks over pin (B) in lower receiver. Pivot magazine rearward until magazine catch (C) engages rear tab (D). Use your hand and tap on the bottom of the magazine to be sure it is seated.

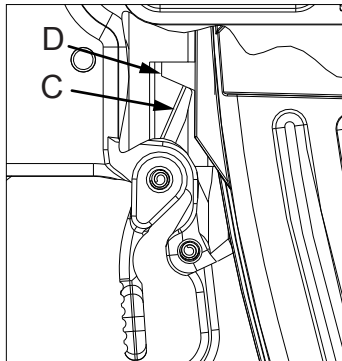
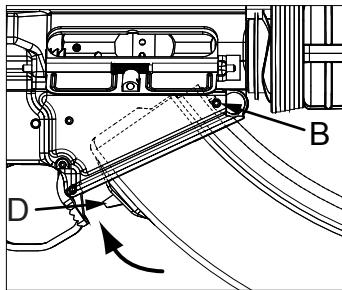

LOADING

⚠ WARNING - Risk of serious injury or death. After performing step 6, the firearm is loaded and will fire if the safety selector is set to FIRE and the trigger is pulled. Keep the firearm pointed in a safe direction at all times.

- To load a round into the chamber, pull the charging handle (E) fully rearward and release. A round from the magazine is now loaded into the chamber.

⚠ WARNING - Never insert a round into the chamber through the ejection port. Load the chamber by feeding a round from the magazine only.

- Check that bolt is in full battery lock up by verifying alignment of markings (F) on upper receiver and bolt carrier.

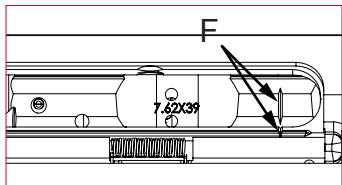
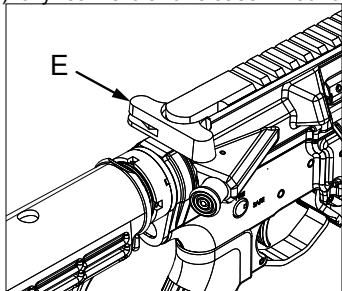

FIRING

⚠ WARNING - You must follow all of the safety guidelines to ensure the safe use of your firearm. Failure to follow these basic firearm safety guidelines may result in an unintended discharge which could cause serious injury or death.

⚠ Always point the firearm in a safe direction. Be alert and follow safety instructions.

⚠ Be aware of others. Persons in the vicinity of your shooting may unintentionally walk into your line of fire.

⚠ Always wear appropriate eye and ear protection while firing. Be sure others in the vicinity have protection. Persons without eye and hearing protection must be 10 yards or more behind the firearm when it is fired.



1. Grasp the firearm with one hand on the handguard and the other on the grip.

⚠ Do not grasp magazine. Grasping magazine may tip the magazine, resulting in a mis-feed. In the unlikely event of an out-of-battery detonation of a round, the firearm is designed to force the generated blast downward through the magazine well.

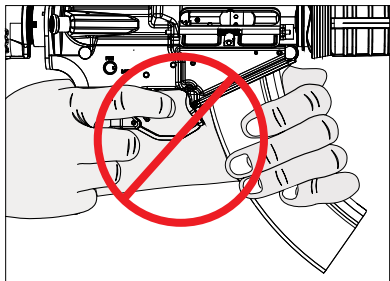

FIRING

2. Move the safety selector (A) to FIRE.
3. Aim at the target and gently pull the trigger with your index finger to fire. Release trigger and point the firearm in a safe direction.
4. When you stop firing, remove your finger from the trigger. Place the safety selector (A) in the SAFE position.

Note: If hammer is not cocked, safety selector can not be placed on SAFE. Always check the chamber to verify it is empty.

⚠ WARNING - Risk of serious injury or death. The firearm may have a round in the chamber even though the magazine has been removed. Keep the firearm pointed in a safe direction while the magazine is reloaded.

5. Unload the firearm. **See Unloading on page 23.**
6. Remove magazine and reload if you plan to continue shooting. **See Loading on page 15.**

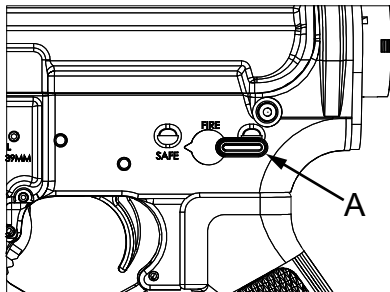
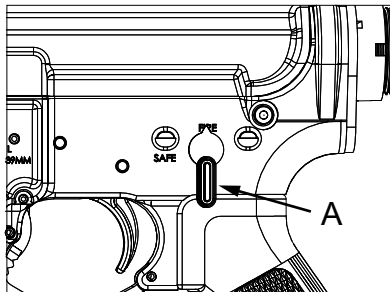

MALFUNCTIONS

⚠ WARNING - Risk of serious injury or death. If your firearm is not operating properly, stop firing immediately. Point the firearm in a safe direction and unload the firearm. Safely store the firearm and take it to a qualified gunsmith for inspection.

If a cartridge jams or hangs up while moving from the magazine into the chamber, do not attempt to force the cartridge into the chamber. If your firearm misfires or jams:

1. Place safety selector (A) on SAFE.

Note: If hammer is not cocked, safety selector can not be placed on SAFE.

2. Grasp the firearm while keeping your finger off the trigger. Push magazine latch (B) forward and remove magazine (C).
3. Pull charging handle (D) rearward.

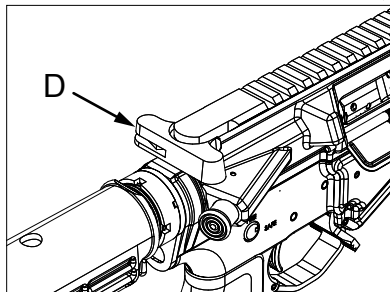
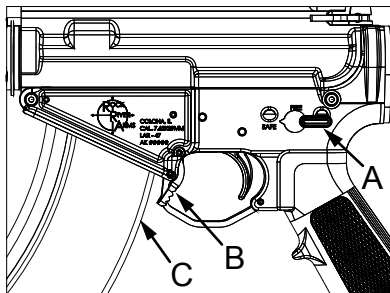

MALFUNCTIONS

4. While holding charging handle back, look into the receiver and verify that there is no ammunition in the chamber (E). With safety selector pointing toward SAFE, release charging handle, allowing bolt to go forward.

⚠ If your firearm stops firing with a live round in the chamber of a hot barrel (misfire), remove the round quickly. However, if you cannot remove it within 10 seconds, remove the magazine and wait 15 minutes with the barrel pointing in a safe direction. This way you won't be hurt by a round possibly "cooking-off" (i.e. the round detonating just from the heat of the barrel). In any event, keep your face away from the ejection port while clearing a hot chamber.

5. In the event that the cartridge cannot be removed, verify that safety selector is in SAFE position.

NOTICE - Pushing takedown pin past the second detent position (with closed being the first position) will result in irreparable damage to the lower receiver.

6. While the barrel is still pointed down range, push takedown pin (F) to the second detent position. If tight, use the chamber flag as a tool to push pin to second detent position. Never use a punch to drive the pin.

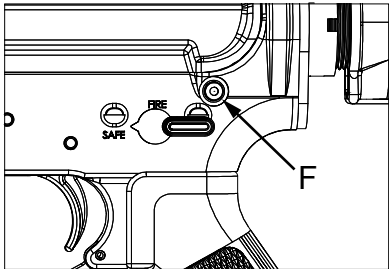
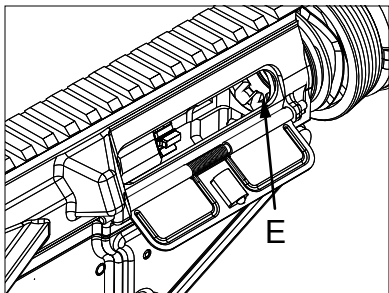

MALFUNCTIONS

NOTICE - Pushing pivot pin past the second detent position (with closed being the first position) will result in irreparable damage to the lower receiver.

7. Push pivot pin (G) to the second detent position. If tight, use the chamber flag as a tool to push pin to second detent position. Never use a punch to drive the pin.
8. Separate upper receiver from lower receiver.
9. Remove bolt carrier group if possible. Take components to a competent and qualified gunsmith for repair.

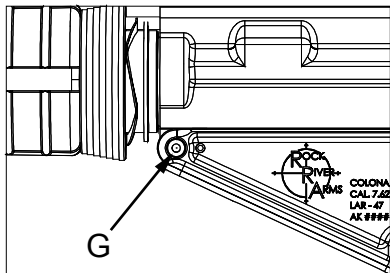

UNLOADING

⚠ Firearms must be unloaded when not in use. Completely unload firearm as soon as you are finished shooting. Unload firearm before storing it, traveling, laying it down or entering a vehicle or building. Always verify that a firearm is unloaded. Do not take anyone's word that a firearm is unloaded. Never pass your firearm to another person until both you and the other person have visually checked that it is unloaded. Keep your firearm unloaded and safely stored when not in use.

⚠ WARNING - Risk of serious injury or death. Always point the firearm in a safe direction.

1. Place safety selector (A) on SAFE.

Note: If hammer is not cocked, safety selector can not be placed on SAFE.

2. Grasp the firearm while keeping your finger off the trigger. Push magazine latch (B) forward and remove magazine (C).

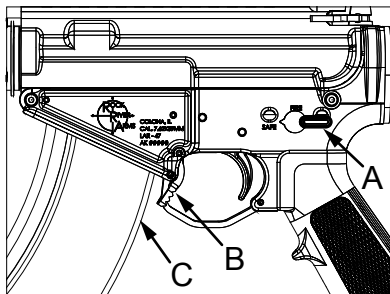

UNLOADING

3. Pull charging handle (D) rearward.
4. Look into the receiver and verify that there is no ammunition in the chamber (E).
5. The LAR-47 is not equipped with a bolt hold open device. Once you have verified that the chamber is empty, insert provided chamber flag as a visual indicator for yourself and others that the chamber is empty.

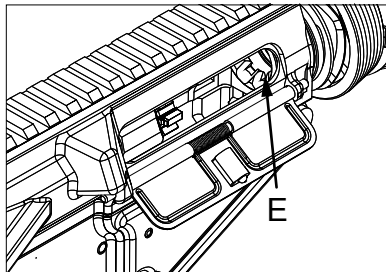
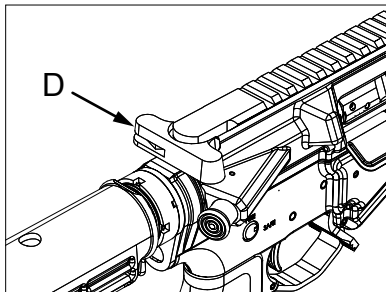

⚠ WARNING - Risk of serious injury or death. Verify that the firearm is not loaded before any disassembly or cleaning. Always point the firearm in a safe direction.

⚠ WARNING - Risk of serious injury or death. Do not disassemble firearm any further than instructed in this manual. Do not modify or alter firearm. Never interchange parts from other firearms.

⚠ WARNING - Disassembling the firearm and the handling of ammunition and cleaning products may result in exposure to lead and other substances known to cause birth defects, reproductive harm, cancer, and other physical injury. Wash hands thoroughly after exposure. Read the warnings and labels on all ammunition and cleaning products carefully.

⚠ WARNING - Risk of eye injury. Wear eye protection while disassembling firearm.

SEPARATE UPPER AND LOWER RECEIVER

1. Verify that the firearm is not loaded. **See *Inspect For Ammunition* on page 12.**
2. Verify safety selector is on SAFE and bolt is in the forward position.

NOTICE - Pushing takedown pin past the second detent position (with closed being the first position) will result in irreparable damage to the lower receiver.

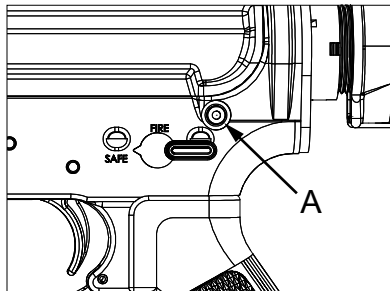

3. Push takedown pin (A) to the second detent position. If tight, use the chamber flag as a tool to push pin to second detent position. Never use a punch to drive the pin.

DISASSEMBLY

NOTICE - Pushing pivot pin past the second detent position (with closed being the first position) will result in irreparable damage to the lower receiver.

4. Push pivot pin (B) to the second detent position. If tight, use the chamber flag as a tool to push pin to second detent position. Never use a punch to drive the pin.
5. Separate upper receiver from lower receiver.
6. Pull rearward on charging handle (C) to remove charging handle and bolt carrier.

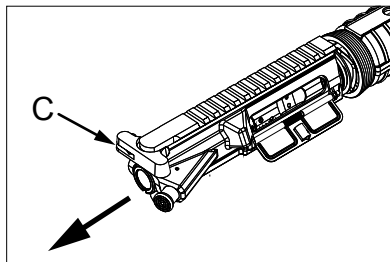
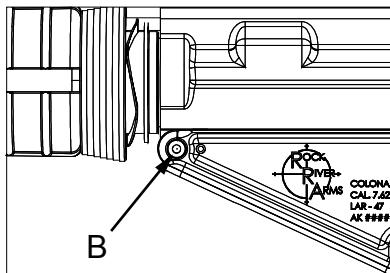

DISASSEMBLE BOLT

1. Remove the firing pin retaining pin (A). Do not distort the ends of the retaining pin.
2. Push the bolt assembly into the bolt carrier to the locked position and remove the firing pin (B) through the rear of the bolt carrier assembly.
3. Rotate bolt cam pin (C) 90° and remove from bolt carrier assembly. If bolt cam pin (C) can not be removed, contact Rock River Arms at (866) 980-7625 or e-mail us at contacttech@rockriverarms.com.
4. Remove bolt (D) from bolt carrier.

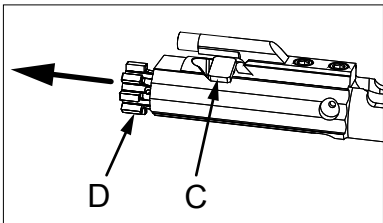
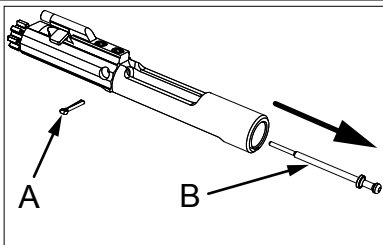

5. Push in on the rear of the extractor (E). If the extractor does not spring back, remove the extractor from the bolt (D) for cleaning. Push extractor pin (F) out to remove extractor.
6. Do not remove extractor spring insert from extractor spring (G).

⚠ WARNING - Risk of serious injury or death. Do not disassemble the firearm any further than instructed in this manual.

⚠ WARNING - Do not modify or alter any part of the firearm. Contact Rock River Arms at (866) 980-7625 or e-mail us at contacttech@rockriverarms.com for replacement parts and/or technical information.

The LAR-47 utilizes proprietary components that are not interchangeable with standard LAR-15 components. These components include:

- Upper Receiver
- Lower Receiver
- Bolt And Bolt Carrier
- Extractor
- Ejector
- Firing Pin
- Barrel
- Barrel Extension
- Magazine Catch And Associated Components
- Trigger Guard
- Hammer Spring
- Magazine

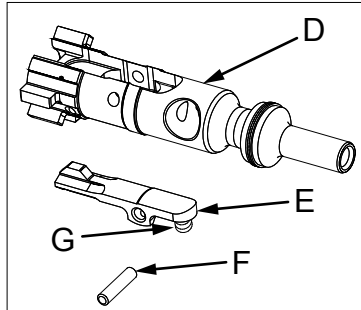
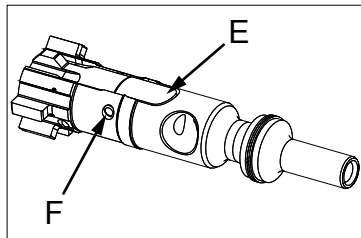

Certain custom configurations may utilize non-standard components as well.

CLEANING

⚠ WARNING - Risk of serious injury or death. Always point the firearm in a safe direction.

⚠ WARNING - Risk of eye injury. Wear eye protection while cleaning firearm.

NOTICE - Risk of firearm damage. Some cleaning solutions and solvents may damage your firearm. Use a cleaning solution that is designed for use on firearms.

Do not allow cleaning rods to scratch/score the inside of the barrel or chamber. RRA recommends the use of a single-piece coated cleaning rod. RRA also recommends cleaning from the breech (chamber) to the muzzle and removal of the patch, brush, jag, or other cleaning device from the rod prior to pulling the rod back through the bore.

Commercial firearm cleaning kits are available from your firearms dealer. Follow the instructions included with the cleaning kit. Use a high quality firearm cleaning kit that includes a cleaning rod, swab holder, cotton flannel bore patches, a small toothbrush, brass wire bristle bore and chamber brushes and a Cleaner/Lubricant/Preservative.

Before initial use and after firing, clean your firearm as soon as possible to make the job easier and to avoid allowing the development of any corrosion.

When your firearm has not been fired, you should clean it at least once or twice a year if you live in a temperate climate, or as often as once a week in a tropical climate.

If the firearm should get wet, dry and clean as soon as possible. Lightly oil once clean and dry.

CLEANING THE EXTERIOR

⚠ Remove the magazine, verify that the firearm is not loaded and safety selector is on SAFE.

Note: If hammer is not cocked, safety selector can not be placed on SAFE.

Wipe all metal surfaces with a clean cloth and then follow up with a lightly oiled cloth.

CLEANING THE BARREL

⚠ Remove the magazine, verify that the firearm is not loaded and safety selector is on SAFE.

Note: If hammer is not cocked, safety selector can not be placed on SAFE.

RRA recommends cleaning the barrel with the upper half removed from the lower half.

Clean the barrel with a cotton patch attached to a cleaning rod. Moisten the patch with cleaning solution. Repeat with clean patches until patch stays clean. Apply cleaning solvent to a bronze bore brush to help loosen particles inside the barrel. After cleaning, run a dry patch through the barrel and then follow with a lightly oiled patch.

CLEANING THE CHAMBER

⚠ Remove the magazine, verify that the firearm is not loaded and safety selector is on SAFE.

Note: If hammer is not cocked, safety selector can not be placed on SAFE.

Clean the chamber and barrel locking lugs with solvent and a chamber cleaning brush. Move the brush through the chamber several times to scrub the inside of the chamber. Use a clean patch to wipe the chamber after cleaning. Repeat with clean patches until patch stays clean. Once clean, apply a light coating of oil to the chamber (remove prior to shooting).

CLEANING THE LOWER RECEIVER

⚠ Remove the magazine, verify that the firearm is not loaded and safety selector is on SAFE.

Note: If hammer is not cocked, safety selector can not be placed on SAFE.

Wipe all metal surfaces with a clean cloth and then follow up with a lightly oiled cloth. Compressed air is useful when cleaning the lower receiver. Always wear eye protection when cleaning with compressed air.

Wipe any debris from the trigger mechanism.

Never apply grease to trigger mechanism.

CLEANING THE UPPER RECEIVER

⚠ Remove the magazine, verify that the firearm is not loaded and safety selector is on SAFE.

Note: If hammer is not cocked, safety selector can not be placed on SAFE.

Wipe all interior and exterior surfaces with a clean cloth and then follow up with a lightly oiled cloth.

Wipe any debris from the bolt carrier channel.

CLEANING THE BOLT CARRIER GROUP

Wipe all bolt carrier group surfaces with a clean cloth and then follow up with a lightly oiled cloth.

Clean any carbon fouling/buildup from both the bolt and carrier using the CAT M4 Bolt Tool (RRA Part AR3550) or similar product. Wipe any debris from the bolt, firing pin, retaining pin, cam pin and extractor.

Checks:

- Check the bolt for cracks or fractures, especially in the cam pin hole area. Bolts with any pitting extending into the firing pin hole must be replaced.
- Check the firing pin to see if it is bent, cracked, too blunt, too sharp or if tip is pitted. If so, it must be replaced.
- Verify that the firing pin moves freely forward and rearward when inserted into the bolt.

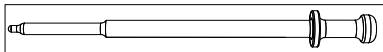
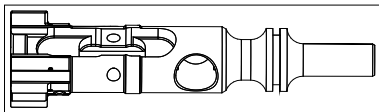

- Check firing pin retaining pin to see if it is bent or badly worn. If so, it must be replaced. Never use a cotter pin as a substitute for a firing pin retaining pin. Cotter pins are not made of heat treated spring steel and their round head shape will cause damage.
- Check the cam pin to see if it is cracked, worn or chipped. If so, it must be replaced.
- Check the extractor and extractor spring to see if the extractor is chipped, or has broken edges in the area of the lip that engages the cartridge rim. If so, it must be replaced.

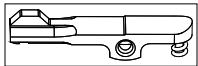
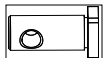
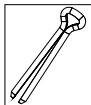

⚠ WARNING - Risk of eye injury. Wear eye protection while lubricating firearm.

UPPER RECEIVER

Lightly Lubricate With Cleaner/Lubricant/Preservative (never use a heavy oil or grease):

- The inside of the upper receiver, bore and chamber using the cleaning rod and a patch.
- The outer surfaces of barrel.

LOWER RECEIVER

Lightly Lubricate With Cleaner/Lubricant/Preservative (never use a heavy oil or grease):

- All moving lower receiver parts including the trigger, hammer, safety, bolt catch, forward assist and their various pins and detents. Don't forget the takedown pin, pivot pin and detents.
- Using Cleaner/Lubricant/Preservative and a clean cloth, wipe the receiver and any other components clean of fingerprints.

BOLT CARRIER GROUP

Lightly Lubricate With Cleaner/Lubricant/Preservative (never use a heavy oil or grease):

- The firing pin and the firing pin recess in the bolt.
- The charging cradle and the inner and outer surfaces of the bolt carrier.
- The bolt, cam pin and bolt gas rings.
- The extractor and extractor pin.
- The slide and cam pin area of the bolt carrier.
- The inside of the carrier key on the bolt carrier should be dried with a cotton swab, then place one drop of Cleaner/Lubricant/Preservative inside.

⚠ WARNING - Risk of eye injury. Wear eye protection while assembling firearm.

ASSEMBLE BOLT

1. Install extractor (A) with insert and spring into bolt and install extractor pin (B). Extractor pin must not extend outside the bolt on either side.
2. Position the three ring gaps (C) 120° apart around the bolt.

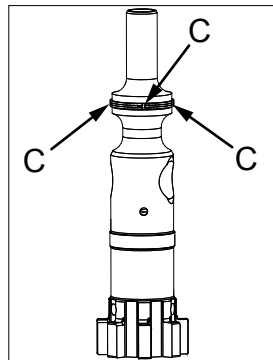
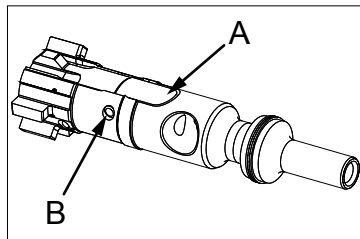

ASSEMBLY

3. Install bolt assembly (D) into bolt carrier. Insert cam pin (E) and rotate 90°. The hole in pin will align with the hole through the bolt.
4. Insert the firing pin (F) through the rear of the bolt carrier assembly.
5. Extend bolt fully forward and install the firing pin retaining pin (G).

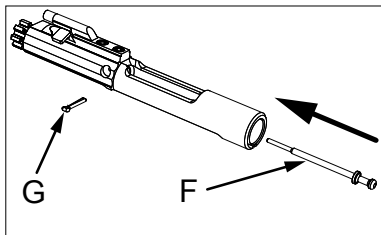
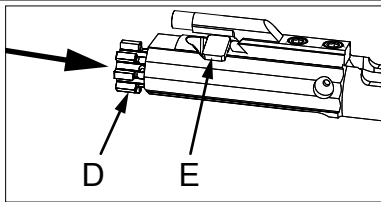

INSTALL BOLT CARRIER

1. Insert charging handle (A) and bolt carrier (B) into upper receiver with longer end of bolt carrier facing the barrel and the bolt extended fully forward.

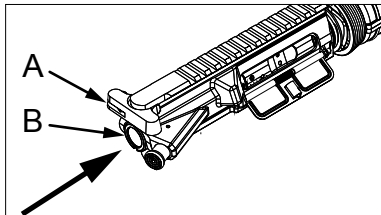

ASSEMBLE UPPER AND LOWER RECEIVER

1. Reassemble upper and lower receiver and push pivot pin (A) in.
2. Verify that hammer is locked back and safety selector on SAFE.
3. Close the upper and lower receivers and push takedown pin (B) in.

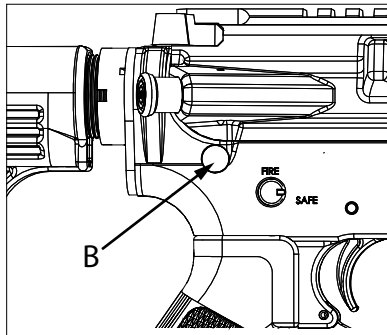
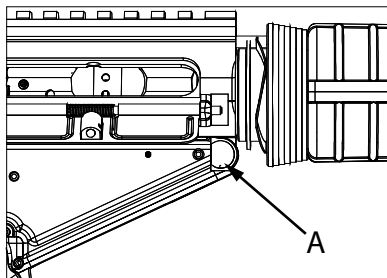

TROUBLESHOOTING

Problem	Check	Solution
Won't fire.	Hammer not cocked.	Charge. See Loading on page 15.
	Selector on SAFE.	Place selector on FIRE.
	Defective ammunition.	Remove magazine and install new, undamaged ammunition See Loading on page 15.
	Improper assembly of firing pin.	Assemble correctly. See Assembly on page 34.
	Too much oil in firing pin recess.	Remove firing pin and wipe out with cotton swab. See Disassembly on page 25.
	Too much carbon on firing pin or in firing pin recess	Disassemble and remove carbon. See Disassembly on page 25.
Won't extract.	Carbon in chamber.	Clean chamber. See Cleaning The Chamber on page 30.
	Fouling or carbon in extractor.	Remove and clean extractor. See Disassembly on page 25.

contacttech@rockriverarms.com. or (866) 980-7625

TROUBLESHOOTING

Problem	Check	Solution
Won't extract, continued.	Extractor sticking or seized.	Remove and clean extractor and recess in bolt. See Disassembly on page 25.
	Restricted movement of bolt carrier.	Remove, clean and lube bolt carrier assembly. See Disassembly on page 25.
Won't feed.	Dirty, damaged, corroded or incorrect ammunition.	Remove magazine and install new, undamaged ammunition. See Loading on page 15.
	Dirty magazine.	Remove and clean magazine.
	Defective magazine.	Replace magazine.
	Too many rounds in magazine.	Remove excess rounds from magazine. See Loading on page 15.
	Magazine not fully seated.	Seat magazine in receiver. See Loading on page 15.
	Dirty/fouled chamber.	Clean chamber. See Cleaning The Chamber on page 30.

TROUBLESHOOTING

Problem	Check	Solution
Bolt won't unlock.	Dirty or burred bolt.	Remove bolt assembly and clean or see a competent and qualified gunsmith. See Disassembly on page 25.
	Dirty/fouled chamber.	Clean chamber. See Cleaning The Chamber on page 30.
Won't chamber.	Dirty, damaged or corroded ammunition.	Remove magazine and install new undamaged ammunition. See Loading on page 15.
	Defective magazine.	Replace magazine.
	Carbon in chamber.	Clean chamber. See Cleaning The Chamber on page 30.
Bolt won't fully close.	Dirt, corrosion, or carbon buildup in barrel locking lugs.	Clean barrel locking lugs. See Cleaning Upper Receiver on Page 31.
	Blown primer in barrel extension.	Remove primer.

contacttech@rockriverarms.com. or (866) 980-7625

TROUBLESHOOTING

Problem	Check	Solution
Won't extract.	Extractor sticking.	Remove and clean extractor. See Disassembly on page 25.
	Restricted movement of bolt carrier.	Remove, clean and lube bolt carrier. See Disassembly on page 25.
	Blown primer in or under extractor.	Remove primer.
Safety selector binds.	Needs oil.	Lubricate with Cleaner/Lubricant/Preservative.
	Debris in trigger.	Clean trigger. See Cleaning Lower Receiver on Page 31.

Page intentionally left blank.

PARTS

Barrel Assembly

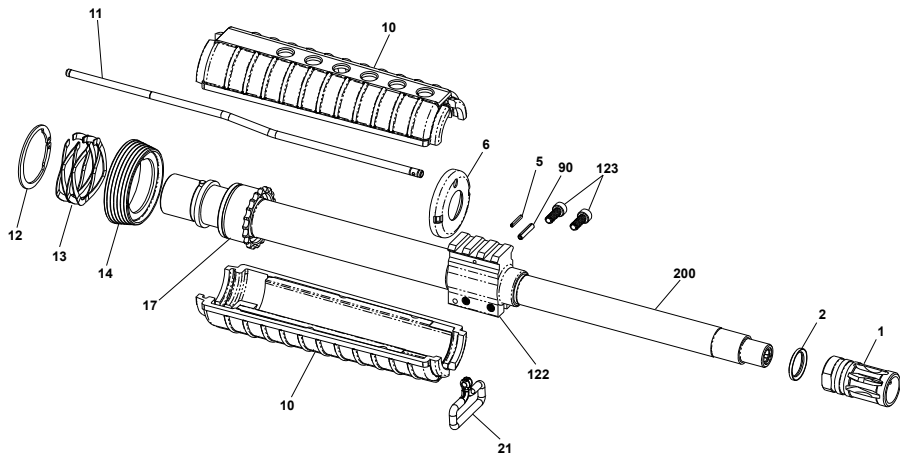

PARTS

Item	Part Number	Description	Qty
1.....	SPC0001A2	A2 Flash Hider	1
2.....	308A0002	Washer.....	1
5.....	AR0005GB	Gas Block Spiral Pin	1
6.....	AR0006A.....	Handguard Cap, Round.....	1
10.....	AR0010A.....	Hand Guard	1
11.....	AR0011A.....	Gas Tube, CAR.....	1
12.....	AR0012	Handguard Snap Ring	1
13.....	AR0013	Weld Spring	1
14.....	AR0014	Delta Ring	1
17.....	AR0017	Barrel Nut, Standard.....	1
21.....	AR0021	Front Sling Swivel.....	1
90.....	AR0090	Trigger Guard Pin	1
122.....	AR0122	Gas Block, Heavy Barrel.....	1
123.....	AR0123	Screw, Gas Block.....	2
200.....	AK0200CL.....	Barrel.....	1

PARTS

Upper Receiver

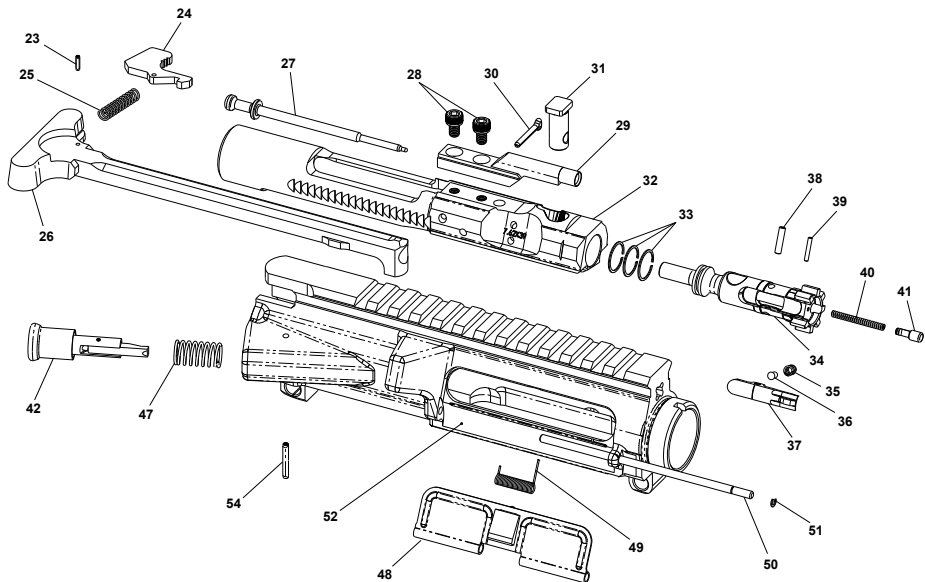

PARTS

Item	Part Number	Description	Qty
23	AR0023	Charging Handle Latch Roll Pin	1
24	AR0024	Charging Handle Latch	1
25	AR0025	Charging Handle Latch Spring	1
26	AR0026	Charging Handle	1
27	AK0027	Firing Pin	1
28	AR0028C	Gas Key Screws, Stainless Steel	2
29	AR0029C	Gas Key, Chrome	1
30	AR0030	Firing Pin Retaining Pin	1
31	AR0031C	Cam Pin, Chrome	1
32	AK0032A	Chromed Bolt Carrier	1
33	AR0033	Bolt Gas Ring, Straight Cut	3
34	AK0034	Chromed Bolt	1
35	AR0035	Extractor Spring	1
36	AR0036	Extractor Spring Insert	1
37	AK0037	Extractor	1
38	AR0038	Extractor Pin	1
39	AR0039	Ejector Roll Pin	1
40	AR0040	Ejector Spring	1
41	AK0041	Ejector	1
42	AR0042ASY	Forward Assist Assembly	1
47	AR0047	Forward Assist Spring	1
48	AR0048	Ejection Port Cover	1
49	AR0049	Ejection Port Cover Spring	1
50	AR0050	Ejection Port Cover Pin	1
51	AR0051	Pin Retaining Clip	1
52	AK0052B	Flat Top Upper Receiver	1
54	AR0054	Forward Assist Pin	1

Note: All parts illustrated and/or listed are not used in all models/configurations.

PARTS

Lower Receiver

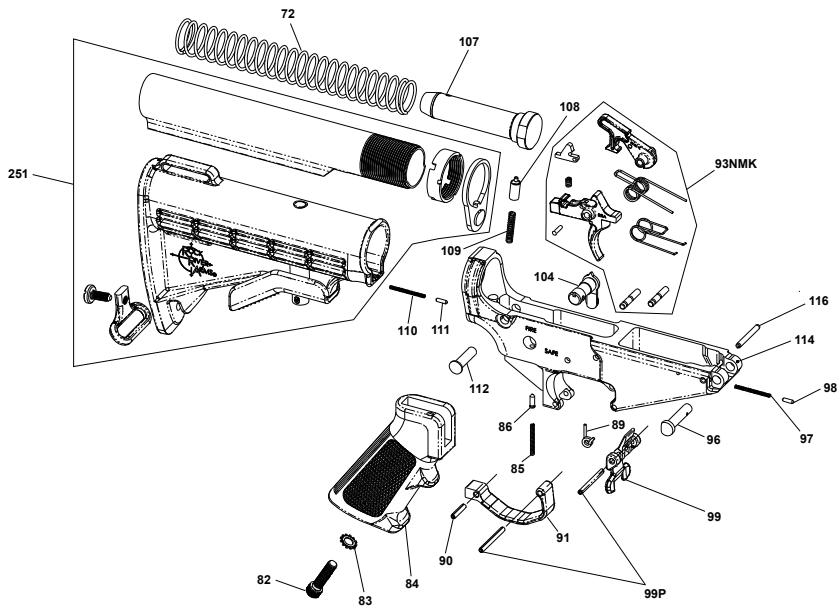

PARTS

Item	Part Number	Description	Qty
72	AR0072A	Action Spring, CAR	1
82	AR0082	Pistol Grip Screw	1
83	AR0083	Lock Washer	1
84	AR0084OM	Over-Molded A2 Grip, Black	1
85	AR0085	Safety Detent Spring	1
86	AR0086	Safety Detent	1
89	AK0089	Magazine Catch Spring	1
90	AR0090	Trigger Guard Pin	1
91	AK0091	Winter Trigger Guard	1
93NMK	AK0093NMK	Trigger, Assembly	1
96	AR0096	Pivot Pin	1
97	AR0097	Pivot Pin Spring	1
98	AR0098	Pivot Pin Detent	1
99	AK0099	Magazine Catch	1
99P	AK0099PIN	Magazine Catch Pin / Front Trigger Guard Pin	2
104	AR0104	Safety Selector Lever	1
107	AR0107A	Buffer, CAR Safety	1
108	AR0108	Buffer, Retainer	1
109	AR0109	Buffer Retainer Spring	1
110	AR0110	Takedown Pin Spring	1
111	AR0111	Takedown Pin Detent	1
112	AR0112	Takedown Pin	1
114	AK0114RRA	Lower Receiver	1
116	AK0116PIN	Magazine Pin	1
251	AR0251	Stock Assembly	1
NS	MANUAL47	LAR-47 Manual	1

Note: All parts illustrated and/or listed are not used in all models/configurations.

WARRANTY

ATTENTION SHOOTERS!

Congratulations on your new purchase. The barrel on your new firearm comes lapped in from the factory, therefore, no break in of the barrel is required. Refer to the manual included with your firearm for assistance with disassembly, cleaning and re-assembly of your firearm.

⚠ WARNING

If this firearm is carelessly or improperly handled, unintentional discharge could result and could cause injury, death or damage to property.

Do not use handloads, reloads or remanufactured ammunition in your ROCK RIVER ARMS firearm. Use of this ammunition is dangerous and by using it you assume all risks associated with its use. The use of handloads, reloads or remanufactured ammunition in this firearm will void the Limited Lifetime Warranty.

IMPORTANT!

Before your firearm left the factory, it was tested, carefully inspected and packaged. Rock River Arms cannot control product handling after it leaves the factory. Therefore, please examine this firearm carefully at the time of purchase to insure that it is unloaded and undamaged.

Serial # _____

Purchase Date _____

Dealer _____

LIMITED LIFETIME WARRANTY

ROCK RIVER ARMS warrants to the initial retail purchaser, for his/her lifetime, that this firearm, used under normal conditions, will be free of defects in parts, material and workmanship which affect satisfactory operation of the firearm.

This warranty is in force only upon completion of this warranty form by the purchaser and transmittal to ROCK RIVER ARMS.

This warranty is limited to the repair or replacement of the part or parts which are returned to ROCK RIVER ARMS and which are determined by ROCK RIVER ARMS to be defective. This warranty, made to the original owner/purchaser, is not transferable. The following items are excluded from this warranty: A. Normal wear of protective finishes and of all metal or plastic parts; B. Damage or malfunction resulting from accident, negligence, misuse or unauthorized repair or alteration; C. Damage from use of other than factory ammunition.

NOTICE OF DISCLAIMER OF LIABILITY

ROCK RIVER ARMS will not be responsible for the results of careless handling, unauthorized repairs and adjustments, corrosion, neglect, unreasonable or unsafe use. ROCK RIVER ARMS assumes no responsibility for damage and/or injury caused in whole or in part by handloaded, reloaded or defective ammunition. Under no circumstances shall ROCK RIVER ARMS be responsible for incidental or consequential damages with respect to economic loss or injury to property arising out of use of handloaded or remanufactured ammunition, negligence, unsafe handling or unauthorized modifications to the firearm. Some states do not allow the exclusion or limitation of incidental or consequential damages, so the above limitations regarding them may not apply to you.

WARRANTY MUST BE COMPLETED BY PURCHASER AT TIME OF PURCHASE



Rock River Arms, Inc.
1042 Cleveland Road
Colona, IL 61241

Toll Free Line: 866-980-7625
Telephone: 309-792-5780
Fax: 309-792-5781

Information E-Mail: info@rockriverarms.com
Technical Support E-Mail: contacttech@rockriverarms.com
Website: rockriverarms.com

⚠ WARNING - Read and understand this manual before handling the firearm. If you do not understand any part of this manual, contact Rock River Arms for assistance.

LAR-47 RIFLES

OPERATING & SAFETY INSTRUCTION MANUAL

June 2014
PN: Manual47