

TRG

TRG 22 A1

TRG 42 A1

INSTRUCTION MANUAL

MADE IN FINLAND

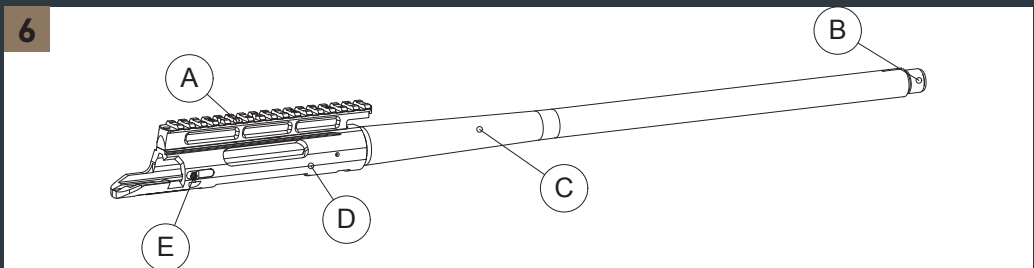
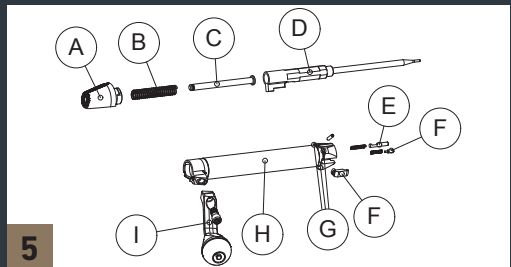
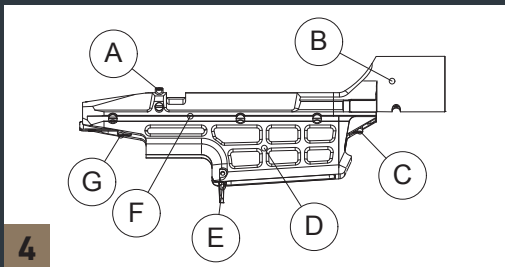
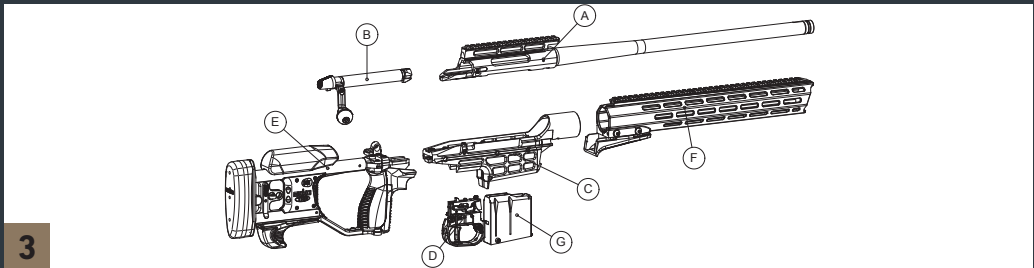
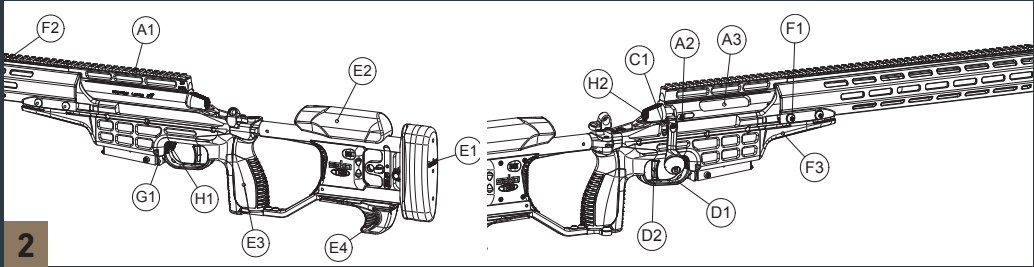
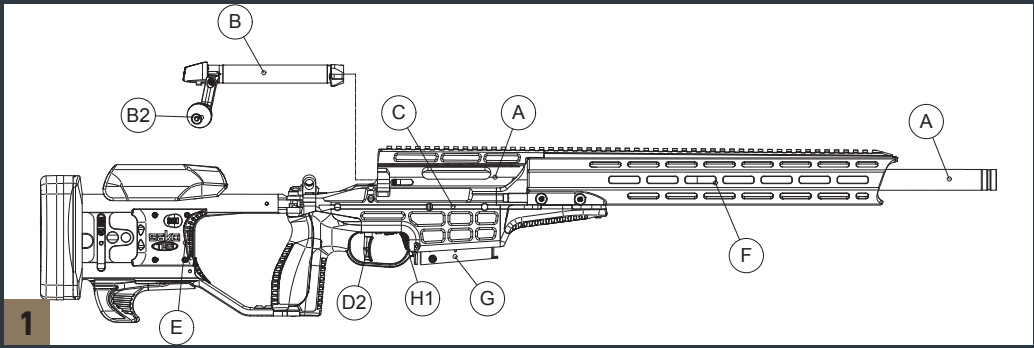

SPARE PART MAP

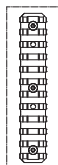
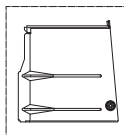
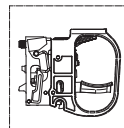
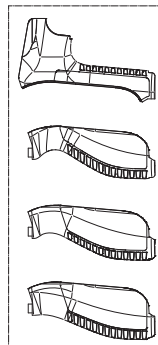
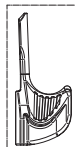
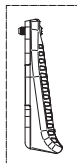
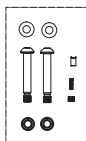
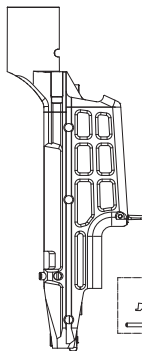
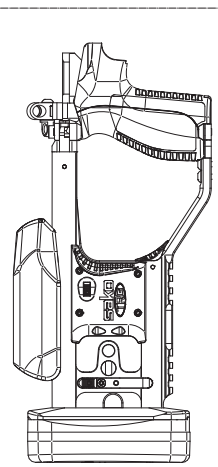
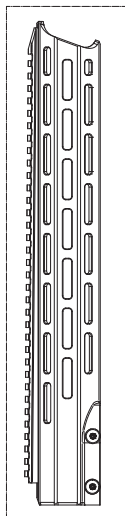
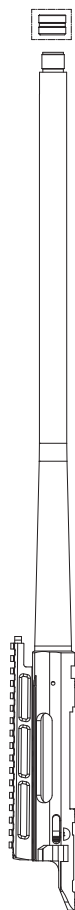
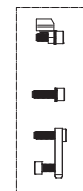
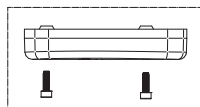
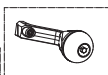
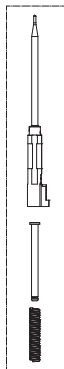
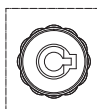

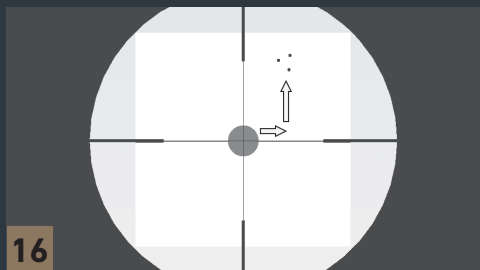
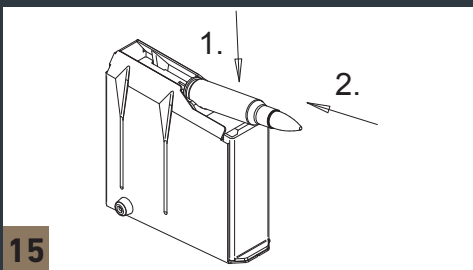
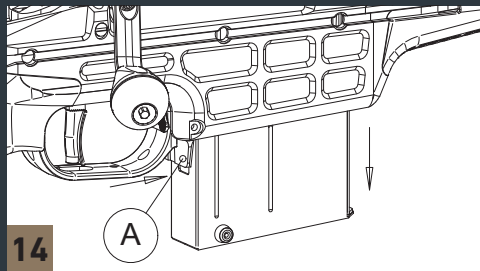
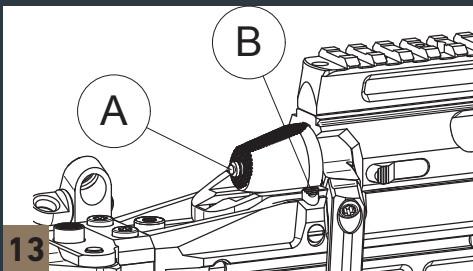
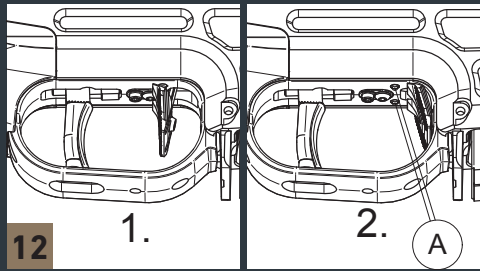
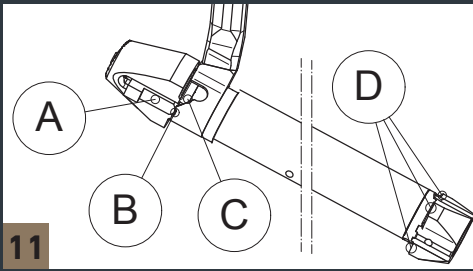
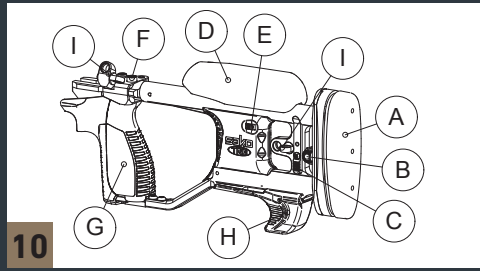
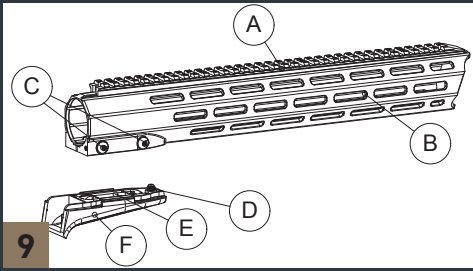
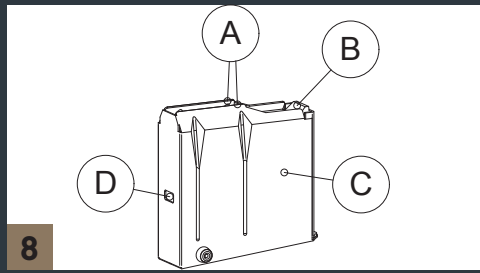
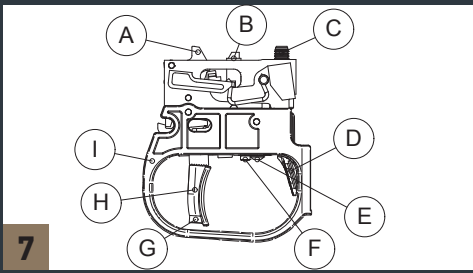

sako

CERTIFICATION OF PROOF TEST AND ACCURACY

Each rifle manufactured by SAKO Ltd. is proof tested by firing two high pressure cartridges and inspected for safety according to C.I.P. regulations.

After proof testing this rifle has been test shot using SAKO Ltd. manufactured ammunition in order to verify the rifle's accuracy and functionality. Upon leaving the factory, SAKO Ltd. guarantees this rifle to have a minimum performance of 1 M.O.A. or better, at 100 meters with 5 cartridges.

The lion head figure below is the inspection mark of the Finnish national proof house for firearms. This mark verifies that the firearm has been tested according to C.I.P. regulations and is safe to use.



In Finland the proof testing is controlled and supervised by the National Police Board-Firearms Inspection Department.

SAKO LIMITED, RIIHIMÄKI, FINLAND, Tel. (+358) 10 830 5200, www.sako.fi

THIS MANUAL APPLIES TO ALL SAKO TRG 22/42 A1 MODEL VARIATIONS AND INCLUDES EXPLANATIONS AND DESCRIPTIONS OF STANDARD AS WELL AS OPTIONAL FEATURES AND EQUIPMENT. PLEASE FOLLOW MATERIAL THAT IS APPLICABLE TO YOUR SPECIFIC SAKO TRG 22/42 A1 MODEL.

CONTENTS

INDICATIONS IN THIS MANUAL	4
IMPORTANT PRECAUTIONS	4
BASIC SAFETY RULES	5
NOMENCLATURE	7
DESCRIPTION	7
LIST OF ABBREVIATIONS AND UNITS	7
WEAPON IDENTIFICATION DATA	7
SYSTEM COMPONENTS	8
BARRELED RECEIVER	8
BOLT	8
BODY	8
TRIGGER MECHANISM	8
MAGAZINE	8
HANDGUARD	8
BUTTSTOCK	9
ASSEMBLY OF PACKAGED FIREARM	9
OPERATION OF THE SAFETY	10
BOLT HANDLE RELEASE	10
LOAD CHECK	10
OBSTRUCTION CHECK	11
AMMUNITION	11
DRY FIRING/"DUMMY" ROUNDS	12
LOADING AND FIRING	12
LOADING THE MAGAZINE	12
LOADING AND FIRING	12
UNLOADING THE RIFLE	13
SIGHTS AND SCOPE	13
RIFLE SCOPE INSTALLATION	13
SIGHTING IN	13
DISASSEMBLY AND ASSEMBLY OF THE RIFLE COMPONENTS	14
FIELD TOOL SET	14
BOLT	14
MAGAZINE	15
TRIGGER	15
HANDGUARD	15
BUTTSTOCK	15
REAR HOOK	15
RIFLE FUNCTIONS AND ADJUSTMENTS	16
TIGHTENING THE RECEIVER SCREWS	16
TRIGGER PULL WEIGHT ADJUSTMENT	16
ADJUSTING THE TRIGGER LEVER	16
BUTTSTOCK ADJUSTMENTS	17
SLING SWIVEL ATTACHMENT POINTS	18
MUZZLE BRAKE OR SUPPRESSOR ATTACHMENT (IF APPLICABLE)	18
REAR SUPPORT (IF APPLICABLE)	18
ROUTINE CLEANING AND MAINTENANCE	19
STORAGE	20
OPERATIONAL CHANGES OR DAMAGES	20
WARRANTY	21
TECHNICAL DATA	21

ALWAYS KEEP THIS MANUAL WITH YOUR FIREARM. INCLUDE IT WITH THE FIREARM WHEN IT CHANGES OWNERSHIP.

INDICATIONS IN THIS MANUAL

WARNING

A WARNING indicates a condition in which accident, serious injury or even death could result if the WARNING is neglected.

CAUTION

A CAUTION indicates a condition that can cause damage to your weapon if the CAUTION is neglected.

NOTICE

A NOTICE indicates a condition that can be interesting or helpful in the corresponding subject.

IMPORTANT PRECAUTIONS

WARNING

FIREARMS CAN BE DANGEROUS AND CAN POTENTIALLY CAUSE SERIOUS INJURY, DAMAGE TO PROPERTY OR DEATH, IF HANDLED IMPROPERLY. THE FOLLOWING SAFETY RULES ARE AN IMPORTANT REMINDER THAT FIREARM SAFETY IS YOUR RESPONSIBILITY.

WARNING

Always ensure that the safety is engaged until ready to fire.

CAUTION

The Manufacturer and/or its Local Official Distributors assume no liability for product malfunction or for physical injury or property damage resulting in whole or in part from criminal or negligent use of the product, improper or careless handling, unauthorised modifications, use of defective, improper, hand-loaded, reloaded or remanufactured ammunition, customer misuse or neglect of the product, or other factors beyond manufacturer's direct and immediate control.

In addition to the Basic Safety Rules, there are other Safety Rules pertaining to the loading, unloading, disassembly, assembly and use of this firearm, located throughout this manual.

WARNING

READ THE ENTIRE MANUAL CAREFULLY BEFORE USING THIS FIREARM. MAKE SURE THAT ANY PERSON USING OR HAVING ACCESS TO THIS FIREARM READS AND UNDERSTANDS THIS ENTIRE MANUAL PRIOR TO USE OR ACCESS.

WARNING

Do not attempt to load more cartridges into your firearm than local legislation permits. Sako will not be held responsible for any product malfunction, property damage, physical injury or legal repercussions which have been caused through not abiding by the loading instructions as stated in the Sako product manual. Alterations or adjustments (not contemplated by the manufacturer) to any part of the rifle which change the ammunition capacity voids the manufacturer's warranty.

WE RECOMMEND THE USE OF ORIGINAL SAKO SPARE PARTS AND ACCESSORIES. THE USE OF OTHER MANUFACTURER'S SPARE PARTS AND ACCESSORIES COULD CAUSE MALFUNCTIONS AND/OR BREAKAGES THAT WILL NOT BE COVERED BY THE SAKO WARRANTY.

CAUTION

Before using any chemicals on the rifle, test in small areas that it does not harmfully affect any part of the rifle.

All information contained in this instruction manual is accurate at the time of publication. The illustrations and descriptions given in this brochure are intended as a general guide only, and must not be taken as binding. Sako Ltd., therefore, reserves the right to make, at any moment and without notice, any changes it thinks necessary to improve its models or to meet any requirements of manufacturing or commercial nature.

BASIC SAFETY RULES

⚠ CAUTION

READ THIS MANUAL CAREFULLY BEFORE USING THE RIFLE.

⚠ WARNING

FIREARMS CAN BE DANGEROUS AND CAN POTENTIALLY CAUSE SERIOUS INJURY, DAMAGE TO PROPERTY OR DEATH, IF HANDLED IMPROPERLY. THE FOLLOWING SAFETY RULES ARE AN IMPORTANT REMINDER THAT FIREARM SAFETY IS YOUR RESPONSIBILITY.

1. NEVER POINT A FIREARM AT SOMETHING THAT IS NOT SAFE TO SHOOT.

Never let the muzzle of a firearm point at any part of your body or at another person. This is especially important when loading or unloading the firearm. When you are shooting at a target, know what is behind it. Some bullets can travel over 5 miles. If you miss your target or if the bullet penetrates the target, it is your responsibility to ensure that the shot does not cause unintended injury or damage.



2. ALWAYS TREAT A FIREARM AS IF IT WERE LOADED.

Never assume that a firearm is unloaded. **The only certain way to ensure there are no cartridges in a firearm is to open the chamber and visually and physically examine the inside to see if a round is present. Removing or unloading the magazine will not guarantee that a firearm is unloaded or cannot fire.** Shotguns and rifles can be checked by cycling or removing all rounds and by then opening and inspecting the chamber so that a visual inspection of the chamber for any remaining rounds can be made.

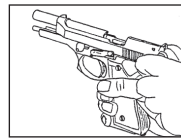
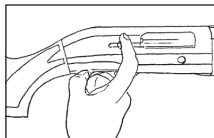
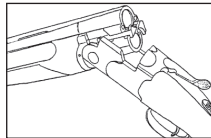
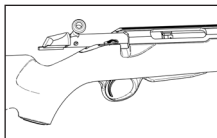

3. STORE YOUR FIREARM SO THAT CHILDREN CANNOT GAIN ACCESS TO IT.

It is your responsibility to ensure that children under the age of 18 or other unauthorised persons do not gain access to your firearm. **To reduce the risk of accidents involving children, unload your firearm, lock it and store the ammunition in a separate locked location.** Please note that devices intended to prevent accidents - for example, cable locks, chamber plugs, etc., - may not prevent use or misuse of your firearm by a determined person. Firearm storage in a steel gun safe may be more appropriate to reduce the likelihood of intentional misuse of a firearm by a child or unauthorised person.

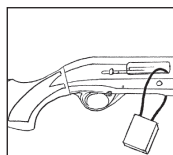
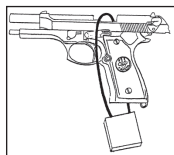
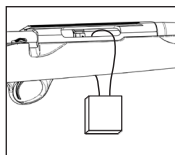

4. NEVER SHOOT AT WATER OR AT A HARD SURFACE.

Shooting at the surface of water or at a rock or other hard surface increases the chance of ricochets or fragmentation of the bullet or shot, which can result in the projectile striking an unintended or peripheral target.



5. KNOW THE SAFETY FEATURES OF THE FIREARM YOU ARE USING, BUT REMEMBER: SAFETY DEVICES ARE NOT A SUBSTITUTE FOR SAFE HANDLING PROCEDURES.

Never rely solely on a safety device to prevent an accident. It is imperative that you know and use the safety features of the particular firearm you are handling, but accidents can best be prevented by following the safe handling procedures described in these safety rules and elsewhere in the product manual. To further familiarise yourself with the proper use of this or other firearms, take a Firearms Safety Course taught by an expert in firearms use and safety procedures.

6. PROPERLY MAINTAIN YOUR FIREARM.

Store and carry your firearm so that dirt or lint does not accumulate in the working parts. Clean and oil your firearm, following the instructions provided in this manual, after each use to prevent corrosion, damage to the barrel or accumulation of impurities which can prevent use of the firearm in an emergency. Always check the bore and chamber(s) prior to loading to ensure that they are clean and free from obstructions. Firing with an obstruction in the barrel or chamber can rupture the barrel and injure you or others nearby. In the event you hear an unusual noise when shooting, stop firing immediately, engage the manual safety and unload the firearm. Make sure the chamber and barrel are free from any obstruction, like a bullet blocked inside the barrel due to defective or improper ammunition.



7. USE PROPER AMMUNITION.

Only use factory-loaded, new ammunition manufactured to industry specifications: CIP (Europe and elsewhere), SAAMI® (U.S.A.). Be certain that each round you use is in the proper calibre or gauge and type for the particular firearm. The calibre or gauge of the firearm is clearly marked on the barrels of rifles/shotguns and on the slide or barrel of pistols. The use of reloaded or remanufactured ammunition can increase the likelihood of excessive cartridge pressures, case-head ruptures or other defects in the ammunition that can cause damage to your firearm and injury to yourself or others nearby.

8. ALWAYS WEAR PROTECTIVE GLASSES AND EARPLUGS WHEN SHOOTING.

The chance that gas, gunpowder or metal fragments will blow back and injure a shooter who is firing a gun is rare, but the injury that can be sustained in such circumstances can be severe, including the possible loss of eyesight. A shooter must always wear impact resistant shooting glasses when firing any firearm. Noise-reducing earplugs or headphones will reduce the risk of damage to hearing caused by prolonged shooting activity.



9. NEVER CLIMB A TREE, FENCE OR OBSTRUCTION WITH A LOADED FIREARM.

Open and empty the chamber(s) of your firearm and engage the manual safety before climbing or descending a tree or before climbing a fence or jumping over a ditch or other obstruction. Never pull or push a loaded firearm toward yourself or another person. Always unload a firearm, visually and physically check to see that the magazine, loading mechanism and chamber are unloaded, and action is open before handing it to another person. Never take a firearm from another person unless it is unloaded, visually and physically checked to confirm it is unloaded, and the action is open.



10. AVOID ALCOHOLIC BEVERAGES OR JUDGEMENT/REFLEX IMPAIRING MEDICATION WHEN SHOOTING.

Do not drink and shoot. If you take medication that can impair motor reactions or judgement, do not handle a firearm while you are under the influence of the medication.



11. NEVER TRANSPORT A LOADED FIREARM.

Unload a firearm before putting it in a vehicle (chamber empty, magazine empty). Hunters and target shooters should load their firearm only at their destination, and only when they are ready to shoot. If you carry a firearm for self-protection, leaving the chamber unloaded can reduce the chance of an unintentional discharge.

12. LEAD WARNING.

Discharging firearms in poorly ventilated areas, cleaning firearms, or handling ammunition may result in exposure to lead and other substances known to cause birth defects, reproductive harm, and other serious physical injury. Have adequate ventilation at all times. Wash hands thoroughly after exposure.

⚠ CAUTION

It is YOUR responsibility to know and abide by Federal, State and Local laws governing the sale, transportation and use of firearms in your area.

⚠ WARNING

This firearm has the capability of taking your life or the life of someone else! Always be extremely careful with your firearm. An accident is almost always the result of not following basic firearm safety rules.

Especially for U.S. consumers:

For information about Firearm Safety Courses in your area, please visit the National Rifle Association's web site at www.nra.org.

NOMENCLATURE

The figure numbers used in this manual refer to the figures on pages **I, II, III, IV & V**.

Refer to figures 1, 2 and 3.

A Barreled receiver	D Trigger	F1 Attachment screws
A1 Top rail	D1 Trigger guard	F2 Top rail
A2 Bolt release	D2 Trigger blade	F3 Tool compartment
A3 Ejection port	E Buttstock	G Magazine
B Bolt	E1 Adjustable recoil pad	G1 Magazine release
B1 Bolt handle	E2 Adjustable cheek piece	H Safety
B2 Bolt shroud	E3 Interchangeable pistol grip	H1 Safety lever
C Body	E4 Rear hook	H2 Cocking indicator
C1 Bolt handle release lever	F Handguard	

DESCRIPTION

SAKO TRG 22/42 A1 is a bolt-action precision rifle that combines a modified ergonomic chassis from the TRG M10 and the proven barreled receiver from the TRG 22/42. Characteristic to the TRG 22/42 A1 is pinpoint accuracy, ergonomic handling and adaptability with different accessories. TRG 42 A1 is considered to be effective up to a distance of 1500 meters and beyond when using .338 Lapua-Magnum caliber. The continuous picatinny rail on top of the receiver and the handguard allows the use of various sights and night vision equipment. The M-LOK interface on the sides and the bottom of the handguard allows the mounting of various devices or accessories eg. bipod and sling. This manual contains general use and maintenance guidance for users of the SAKO TRG 22/42 A1 precision rifle. This manual applies to all TRG 22/42 A1 models and includes explanations of standard as well as optional equipment. As a result, you may encounter material in this manual that is not applicable to your specific TRG model.

LIST OF ABBREVIATIONS AND UNITS

The table below gives the meaning of abbreviations and units used in this manual.

Abbreviation	Meaning
cal.	Caliber
C.I.P.	Commission internationale permanente pour l'épreuve des armes à feu portatives
Fig.	Figure
g	gram
in.	inch
kg	kilogram
lb	pound (mass)
MIL-STD	Military Standard
mm	millimetre
MOA	Minute of Angle
Nm	Newton metre
QD	Quick Detachable
SAAMI	Sporting Arms and Ammunition Manufacturers' Institute

WEAPON IDENTIFICATION DATA

- Manufacturer: SAKO Ltd. Riihimäki, Finland
- Model: TRG 22 A1, TRG 42 A1
- Denomination: SAKO TRG 22/42 A1

You will find the model and serial number of the rifle stamped on the side of the receiver, while the caliber is shown on the side of the barrel. The bolt of your rifle is packed separately in the package.

SYSTEM COMPONENTS

The SAKO TRG 22/42 A1 comprises of the following main components (Fig. 3):

- | | | |
|----------------------|----------------------|-------------|
| A. Barreled receiver | D. Trigger mechanism | G. Magazine |
| B. Bolt assembly | E. Buttstock | |
| C. Body | F. Handguard | |

Barreled receiver

The barreled receiver is the traditional TRG22/42 part (fig. 6). The Picatinny rail is permanently attached to the top of the receiver. The rail has a 30 MOA forward cant. The TRG 22/42 A1 features a free-floating, cold-hammer forged heavy barrel for extreme accuracy. The barrel has an M18x1 muzzle thread for suppressor or muzzle brake attachment.

- | | | |
|-------------------|-------------|-----------------|
| A. Picatinny rail | C. Barrel | E. Bolt release |
| B. Muzzle thread | D. Receiver | |

Bolt

TRG 22/42 A1 uses an updated TRG 22/42 bolt that has three symmetrical locking lugs for secure locking and a reduced bolt lift angle (fig. 5). TRG 22 A1 bolt has a single ejector and the TRG 42 A1 has a double ejector.

- | | | |
|-----------------------------------|---------------|-----------------|
| A. Bolt shroud | D. Firing pin | G. Locking lugs |
| B. Firing pin spring | E. Ejector | H. Bolt body |
| C. Spring guide/cocking indicator | F. Extractor | I. Bolt handle |

Body

The TRG 22/42 A1 has an aluminium body that contains a handguard fastener, magazine well and the magazine catch (fig. 4).

- | | | |
|----------------------------------|---------------------|-------------------|
| A. Bolt handle release button | D. Magazine well | G. Receiver screw |
| B. Handguard fastener | E. Magazine release | |
| C. Receiver screw and recoil lug | F. Cable channel | |

Trigger mechanism

The TRG 22/42 A1 uses the TRG M10 trigger mechanism (fig. 7). It is equipped with an adjustable two-stage trigger. The first stage movement requires a slight pull pressure. The second stage fires the weapon when there is a small increase in pull pressure.

- | | | |
|---------------------|---------------------------------|-----------------------------|
| A. Sear | D. Safety lever | G. Trigger adjustment screw |
| B. Bolt locking pin | E. Adjustment limiting screw | H. Adjustable trigger blade |
| C. Fastening screw | F. Pull weight adjustment screw | I. Trigger guard |

Magazine

The detachable magazines are the same ones used in the trg 22/42 (fig. 8). They are of a two row staggered center-feeding type. There are three different magazines:

- TRG 22 A1: 10 rounds, 260 Rem, 308 Win, 6.5 Creedmoor
- TRG 42 A1: 7 rounds, 300 Win Mag
- TRG 42 A1: 5 rounds, 338 LM

- | | |
|----------------------|----------------------------------|
| A. Feed lips | C. Steel magazine box |
| B. Magazine follower | D. Slot for the magazine release |

Handguard

The handguard has an integral 30MOA rail on top and 7 M-LOK interfaces on the sides and the bottom (fig. 9). It also acts as a heat shield around the barrel and it transfers the heat mirage away from the centerline. There is a tool compartment on the bottom rear of the handguard that also acts as a place to hold the weapon.

- | | | |
|-----------------------|-------------------------------|---------------------|
| A. Top picatinny rail | C. Handguard fastening screws | E. Tools |
| B. M-LOK interface | D. Tool compartment screw | F. Tool compartment |

Buttstock

The buttstock is the same as in the TRG M10 (fig. 10). The buttstock is foldable in order to make the rifle more compact and maneuverable. The stock provides multiple adjustment options to fine-tune the position for every preference.

- | | | |
|--|---|-----------------------------------|
| A. Adjustable recoil pad | D. Adjustable cheek piece | G. Interchangeable pistol grip |
| B. Recoil pad height adjustment button | E. Cheek piece height adjustment button | H. Rear hook / rail cover |
| C. Length of pull adjustment button | F. Stock folding button | I. Sling swivel attachment points |

ASSEMBLY OF PACKAGED FIREARM

WARNING

THIS FIREARM HAS THE CAPABILITY OF TAKING YOUR LIFE OR THE LIFE OF SOMEONE ELSE! ALWAYS BE VERY CAREFUL WHEN HANDLING YOUR FIREARM. AN ACCIDENT IS NEARLY ALWAYS THE RESULT OF FAILURE TO COMPLY WITH SAFETY RULES, OR INCORRECT USE.

CAUTION

Sako assumes no liability for any injury or damage to property resulting from improper or careless handling, or intentional or accidental firing of the rifle.

WARNING

All assembly, disassembly and maintenance procedures should be carried out with the firearm unloaded (cartridge chamber, receiver and magazine empty). Inspect the firearm by looking through barrel from the rear end of the receiver. During assembly, disassembly and maintenance procedures, never point a firearm at someone or at hard or flat surfaces. Always treat the firearm as if it were loaded (See points 1, 2 and 4 of the BASIC SAFETY RULES).

NOTICE

It is advisable to carry out the assembly operations over a table to catch components should they drop.

Do the following preparations before starting to use the rifle:

- Wipe the oil from the barrel by pushing a dry patch through it, starting from the breech end.
- Clean extra oil from the bolt, chamber and breech area in the receiver.
- Check that the recessed bolt space in the receiver and locking lugs in the bolt (A, fig. 11) are clean. Make sure that locking lug surfaces (D), camming slope (C) and head of the cocking piece (B) are all lightly greased.
- Check that the sights (if equipped) are clean and free of debris.
- Check the tightness of the screws, especially the receiver screws (A, fig. 25).
- Insert the bolt into the receiver.
- If a telescopic sight is to be used, attach mounts and scope according to instructions provided with the scope mounts.

After performing the above check points, your rifle is now ready for test firing. Before using the firearm, you must thoroughly familiarize yourself with its use and operation, and with safe firearm handling in general.

WARNING

Store your firearm so that children or other persons not familiar with firearms cannot gain access to it. To reduce the risk of accidents involving children, unload your firearm and lock it away. Store the ammunition in a separate locked location. (See point 3 of the BASIC SAFETY RULES.)

OPERATION OF THE SAFETY

“The safety” is a firearm’s mechanism that blocks movement of the trigger, sear and bolt handle. The safety lever is located inside the trigger guard extending to the sides, where it can be reached by the index finger. The safety is engaged ON when the safety lever has been pulled backwards to its rearmost position. The safety can only be engaged when the bolt is cocked.

The safety lever has the following conditions (fig. 12):

1. Safety is in the “ON” position and the red safety indicators (A) are hidden.
2. Safety is in the “OFF” position (READY TO FIRE) and the red safety indicators (A) are visible.

The cocking indicator has the following conditions (fig. 13):

1. The red cocking indicator (A) is visible, the rifle is cocked (READY TO FIRE).
2. The cocking indicator (A) is hidden, the rifle is uncocked.

For transportation, the rifle must be unloaded, uncocked and the safety in the “OFF” position.

When the safety is engaged ON it locks:

- The bolt in the closed position
- The firing pin to the cocked position
- Movement of the sear and trigger blade.

WARNING

The manual safety is merely a mechanical device and is in no way a substitute for the Basic Safety Rules of firearm handling.

NOTICE

The safety can only be engaged with the firing pin cocked. The firing pin is cocked by opening the bolt. When the safety lever has been pushed forward (red dots inside the trigger guard are shown), the SAFETY IS DISENGAGED (position 2, fig. 12) and the firearm is READY TO FIRE. When the safety lever is pulled backwards (red dots hidden), the SAFETY IS ENGAGED (position 1, fig. 12).

BOLT HANDLE RELEASE

Sako TRG 22/42 A1 features a bolt handle release that allows the bolt to be opened while the safety has been engaged. Proceed as follows:

1. Close the bolt and move the safety lever backwards (ON).
2. Push the bolt release button (B, fig. 13) and simultaneously lift the bolt handle and move it backwards.

LOAD CHECK

At various points in this manual, you will be instructed to visually check to be certain your rifle is unloaded. This should become second nature to you, as should the following precautions:

- Never assume that the rifle is unloaded.
- Never point or push a firearm toward yourself or another person.
- Always visually check to see that the chamber is unloaded.
- Remove the magazine and open the bolt before handing the rifle to another person.
- Never take from or give the rifle to another person unless the magazine is removed, the bolt opened, and the chamber has been visually checked to confirm it is unloaded.

To visually check to be certain your rifle is unloaded, carefully observe the following steps:

WARNING

Keep your finger OFF THE TRIGGER and the barrel pointed in a SAFE direction.

Inspect the ejection port, the magazine and the chamber as indicated in the following:

1. Remove the magazine by pressing the magazine catch (A, fig. 14) and simultaneously pulling the magazine out

of the rifle.

2. Open the bolt by pressing the bolt handle release button (B, fig. 13) and then opening the bolt.
 3. Check the chamber and the inside of the receiver to make sure that there are no cartridges.
- If the rifle is unloaded, proceed to the following step, otherwise refer to the procedure "Unloading the rifle".

1. Disengage the safety.
2. Close the bolt. **THE FIRING PIN IS NOW COCKED.**
3. With the barrel pointed in a safe direction, decock the firing pin by pulling the trigger.

NOTICE

The firing pin can be decocked only when the bolt is in the closed position.

OBSTRUCTION CHECK

WARNING

Always be certain that the rifle is unloaded. Please refer to the instructions given in the "Load check" paragraph.

Check the barrel to ensure there are no obstructions in the chamber or bore. This is extremely important because serious injury can result to the user or to nearby persons if a cartridge is fired in an obstructed barrel or chamber. Check the inside of the barrel prior to attaching the bolt to the firearm and before use; if the bolt is already attached the following procedure should be followed:

- Remove the magazine.
- Lift the cheek piece in the highest position or fold the buttstock.
- Remove the bolt by pressing the bolt handle release button, lifting the bolt handle, pressing the bolt release button and completely pulling the bolt out of the receiver.
- Look through the barrel from the rear and make sure there are no obstructions, even minor ones.
- If an obstruction in the barrel is detected, try to clean the barrel as instructed in the cleaning and maintenance chapter. If it is not possible to remove it using cleaning equipment a competent gunsmith must remove the obstruction. The rifle should be inspected again before it can be fired.
- Reattach the bolt to the receiver.

AMMUNITION

Use only high-quality ammunition that is manufactured in accordance with C.I.P. (Commission Internationale Permanente pour l'Épreuve des Armes à Feu portatives) or SAAMI (Sporting Arms and Ammunition Manufacturers Institute, Inc.) standards. Be certain that the ammunition is of the appropriate caliber and loading for the firearm and is clean, dry, and in good condition. The cartridge designation for your rifle is marked on the side of the barrel.

WARNING

Carefully inspect each cartridge before it is loaded in the magazine. Be certain the cartridge cases are not split, deformed, or the cartridges do not possess any other dents or defects (this applies even to factory ammunition).

Do not fire old (age over 10 years) ammunition in this firearm. Primers, powder, cartridge cases, and bullets can deteriorate with time and cause damage to the firearm, or injury to the shooter or others. Lead bullets have a tendency to cause bore leading, which may dramatically increase the discharge pressure. Make sure to remove all chamber and bore lead accumulation periodically. **DO NOT** use steel jacketed bullets!

WARNING

Use only high quality, factory manufactured ammunition. The use of reloaded, hand loaded, remanufactured or other non-standard ammunition voids all warranties, and may cause severe damage to the firearm and serious injury to the shooter or others. Improperly loaded ammunition can be extremely dangerous. Always use ammunition that complies with industry performance standards established by the SAAMI or C.I.P. Sako Ltd. does not accept any liability for any damage or injuries caused by reloaded/hand loaded or otherwise improper ammunition.

DRY FIRING/"DUMMY" ROUNDS

Dry firing is defined as firing a firearm with no ammunition in the chamber. Long term dry firing may damage the bolt. "Snap caps" (chamber inserts that allow a firearm to be dry-fired without damaging the rifle) are available at most gun stores for those who wish to practice firing without live ammunition.

⚠ CAUTION

If you want to practice shooting your rifle without using live ammunition (called "dry firing"), insert an appropriate "snap cap" into the chamber to cushion the fall of the firing pin and reduce the chance of firing pin breakage. "Snap cap" cartridges with spring loaded "primers" are ideal. "DUMMY" cartridges with empty primer pockets are good for loading/unloading practice but DO NOT protect the firing pin during dry firing.

LOADING AND FIRING

⚠ WARNING

- Sako assumes no responsibility for any injury or property damage resulting from improper or careless handling, intentional or accidental discharge of the firearm.
- This rifle can have a live round in the chamber and can fire even if the magazine is empty or has been removed.
- Before loading the firearm, become familiar with the following loading procedures without the use of ammunition.
- Never handle a loaded firearm until you are fully familiar with the loading procedures. Always point the firearm in a safe direction.
- Always keep your finger away from the trigger whenever you do not intend to fire. Make sure the rifle is not already loaded by removing the magazine and retracting the bolt in order to check that the chamber is empty.
- Be sure that you have the correct cartridges for your rifle.
- Be sure that the obstruction check has been completed prior to loading.
- Make sure you have wiped cartridge chamber dry before shooting!
- Always wear protective glasses and earplugs whenever you shoot, and make sure that persons close to you are similarly protected (See point 8 of the BASIC SAFETY RULES).

LOADING THE MAGAZINE

- Remove the magazine by pressing the magazine catch (A, fig. 14) and simultaneously pulling the magazine out of the rifle.
- Place a cartridge on the magazine follower in front of the lips at the top of the magazine and slide the cartridge completely under the lips until it is lodged fully inside the magazine body (fig. 15).
- Repeat process until magazine is fully loaded.

⚠ CAUTION

Do not try to force more than the maximum number of rounds indicated for your magazine. An overloaded magazine may not function properly.

LOADING AND FIRING

- When the loaded magazine is inserted into the rifle, lift the bolt and pull it completely back. As the bolt is pushed forwards the cartridge is fed into the chamber and on rotating the handle downward the action is closed and the rifle cocked.
- Pull the safety lever backwards to the "ON" position.,

⚠ WARNING

The firearm is now loaded and ready to fire after the manual safety is disengaged. Always keep your finger off the trigger and avoid contact with the trigger by other objects if you don't intend to fire. Never point a firearm at something that is not safe to shoot. (See points 1, 2 and 4 of the BASIC SAFETY RULES).

- To fire, disengage the safety (red dots visible) and pull the trigger.
- Repeat the sequence to fire another bullet. If you do not plan to fire a second shot, engage the safety (red dots not visible) keeping the firearm pointed in a safe direction and the fingers away from the trigger. If you have finished shooting, unload the rifle as indicated in "Unloading the rifle".

⚠ WARNING

If the rifle doesn't fire after pulling the trigger, engage the safety, wait at least one minute and unload the rifle with extreme care as described in the corresponding section.

ⓘ CAUTION

The bolt of the TRG 22/42 A1 features a spring-loaded single/double plunger ejectors that throw cases when reaching a certain point at the rearward movement. As a result, it is unnecessary to use excessive force to ensure complete ejection of cases. The bolt hitting the bolt release with excessive force may damage the weapon.

UNLOADING THE RIFLE**⚠ WARNING**

Always unload the firearm immediately after firing is completed. Never store a loaded firearm. To store the rifle, refer to the paragraph "Storage".

- Perform a "Load check"
- To unload the magazine, grasp it with one hand around the magazine box, bottom down and front end forward. With the tip of the thumb firmly press down on the cartridge rim and push towards the front of magazine box. As the cartridge moves forward, tip it slightly upward with the index finger. Repeat until the magazine is unloaded.

SIGHTS AND SCOPE**⚠ WARNING**

- Always be certain that the rifle is unloaded before adjusting the sights. Please refer to the instructions given in the "Load check" paragraph.
- Make sure the rifle is pointed in a safe direction.

RIFLE SCOPE INSTALLATION

In order to outfit your TRG 22/42 A1 with a riflescope, you need the appropriate scope mounts. The rifle is equipped with a Picatinny rail on top of the receiver for mounting of a riflescope. Before obtaining scope-mounts, check their compatibility with the rifle (mounting rail type, etc.). Please refer to the instructions of scope mounts for mounting and use.

SIGHTING IN

The following instructions are only general guidelines in the sighting-in of the scope. Specific procedures can vary depending on the scope make and model.

The scope or sights need to be pre-aligned so that actual sighting in procedure is easier. Boresighting can be done with a specific boresighter OR following the procedure below:

1. Place the rifle solidly on benchrest or other steady support (sandbag, etc.) and remove the bolt.
2. Place a target (e.g. paper sheet) at about 25-30 m distance.
3. Adjust the position of the rifle so that you can see the target through the bore. Make sure that the rifle remains stationary.
4. Look through the scope or sights and adjust windage and elevation so that the reticle centers on the same target you see through the bore.

After boresighting, final sighting in is done at a target set at 100-150 m distance. Again, it is best to do this from a solid benchrest or other steady support.

Please follow the adjustment directions and other instructions given by the manufacturer of the riflescope/sight you are using.

When you have prepared properly and are ready to start sighting in, take the following steps:

1. Aim at the bullseye and fire 3 shots.
2. Unload the rifle and check the shot grouping with binoculars or a spotting scope.
3. Adjust the sight (elevation and windage) so that reticle moves to the center of the shot grouping (fig. 16).
4. Repeat the procedure until shot grouping is hitting in the proximity of the bullseye.

NOTICE

Never shoot with rifle resting on the support from the barrel, and never use a hard shooting support (such as bare wood). Doing so can dramatically affect your groups.

DISASSEMBLY AND ASSEMBLY OF THE RIFLE COMPONENTS

WARNING

- Always check that the rifle is unloaded (empty cartridge chamber, empty receiver, empty magazine). Inspect the firearm by looking through the ejection port and the chamber. If it is not empty, unload it as instructed in paragraph "Unloading the rifle". Check that the firing pin is decocked.
- Never point the firearm at someone or at hard, flat surfaces. Always treat the rifle as if it were loaded. (See points 1, 2 and 4 of the BASIC SAFETY RULES.)

NOTICE

It is advisable to carry out the disassembly operations over a table to catch components should they drop.

FIELD TOOL SET

Sako TRG 22/42 A1 has been provided with an onboard tool set that is intended for temporary use only. To get access to the tool set, open the tool compartment fastening screw (A, fig. 17) using e.g. the T25 Torx key in the bolt knob (A, fig. 18).

TRG 22/42 A1 has the following tools onboard:

1. T10, T15 and T25 Torx keys (in the tool compartment).
2. Torx T25 (A, fig. 18).

For regular use and maintenance use full-sized high-quality tools.

BOLT

Generally, disassembling the bolt is not necessary. If you have reason to believe that too much oil may have penetrated the bolt, you should clean it in order to retain its smooth operation. This is particularly important if you use the rifle in cold or harsh weather. The bolt can be disassembled as follows:

1. Remove the bolt by pushing the bolt release and simultaneously pulling the bolt backwards.
2. The firing pin parts are removed by carefully turning the bolt shroud (A, fig. 19) clockwise until its locking notches are disengaged from the bolt body and the bolt shroud springs backwards. Remove the firing pin parts (fig. 5), the firing pin spring (B), spring guide (C) and the firing pin (D).

CAUTION

Hold the bolt shroud tightly because the firing pin spring has tension.

The bolt should not require any further disassembly for cleaning purposes. In order to reassemble the bolt after cleaning, reverse the order:

1. Insert the firing pin parts in place with the bolt shroud (D) so, that the cocking piece (A, fig. 11) is on the opposite side of the bolt handle and the locking notches of the bolt shroud are fitted into position at the rear end of the bolt body.
2. The bolt shroud is then pushed against the bolt, and simultaneously turned counter-clockwise, until the cocking piece head stops in the notch before the cocking slope (B, fig. 11).

NOTICE

When assembling the bolt be sure not to overturn the bolt shroud so that the cocking piece falls forward to the bottom of the cocking slope (C, fig. 11) (uncocked) position. If this happens, turn the bolt shroud clockwise to align the cocking piece with the cocking notch.

MAGAZINE

Disassemble the magazine as follows (fig. 38):

1. Use a tool to push the followers (A) rear end downwards until it is possible to slide the follower forwards and out of the magazine box (D). The magazine spring (B) is attached to the follower.
2. Also remove the bottom cover plate (C).

Assembly is carried out in the opposite order.

⚠ CAUTION

No alterations should be made to magazine feeding lips or to the magazine box in order to correct improper feeding or other malfunction. In case of improper feeding or other malfunction occurs replace the magazine with a complete spare part magazine.

TRIGGER

Remove the trigger assembly as follows (fig. 21):

1. Remove the bolt and magazine.
2. Turn the safety OFF by pushing the safety lever forward.
3. Pull the trigger to allow the T25 Torx-key to be inserted through the opening in the bottom of the trigger guard and loosen the trigger attachment screw.
4. Remove the trigger unit by pulling downwards.

Installation is carried out in reverse order. Tighten the trigger attachment screw to 15 Nm (133 in-lbs).

HANDGUARD

The handguard has been attached with two T25 Torx screws on the right side of the receiver. The fore-end is removed as follows (fig. 22):

1. Loosen the front screw (A) approx. 2 turns with T25 Torx driver.
2. Loosen the rear screw (B) completely and pull it outwards until the integrated stopper stops its outward movement.
3. Carefully slide the fore-end forward out of the handguard fastener.

Reassembly is done as follows (fig. 22):

1. Slide the fore-end over the barrel and onto the handguard fastener. Make sure to mate the Picatinny rail notch (C) with corresponding slot (D) in the top of the handguard Picatinny rail.
2. Push the rear screw (B) into the fore-end.
3. Tighten both fastening screws properly using T25 Torx driver.

📖 NOTICE

Make sure the front fastening screw is opened 1,5-2 turns and the rear screw pulled out before sliding the fore-end back to the receiver.

⚠ CAUTION

The T25 Torx key on the bolt handle is intended to be used only to open the tool compartment. Use dedicated high quality tools for regular use.

BUTTSTOCK

The buttstock can be removed from the receiver assembly as follows (fig. 23):

1. Loosen the top screw (A) 1-2 turns with a T25 Torx key.
2. Do the same for the bottom screw (B).
3. Pull the buttstock rearwards out of the receiver.

Installation of the buttstock is done as follows (fig. 23):

1. Loosen the two fastening screws (A) & (B) enough for clearance.
2. Slide the buttstock into the receiver assembly until the front part of the pistol grip comes into contact with the rear of the lower receiver.
3. Tighten the fastening screws (A) & (B) with a T25 Torx key to 15 Nm (133 in-lbs).

REAR HOOK

The rear hook can be removed from the rear stock as follows (fig. 24):

1. Push the button (A) and extend the length of pull to the rearmost position.
2. Pull the front part of the rear hook slightly downwards and simultaneously push the rear hook backwards until it is released from the rail.

Reassembly of the rear hook is carried out in reverse order.

RIFLE FUNCTIONS AND ADJUSTMENTS

WARNING

- Always check that the rifle is unloaded (empty cartridge chamber, empty receiver, empty magazine). Inspect the firearm by looking through the ejection port and the chamber. If it is not empty, unload it as instructed in the relevant section. Check that the firing pin is decocked.
- Never point the firearm at someone or at hard, flat surfaces. Always treat the rifle as if it were loaded. (See points 1, 2 and 4 of the BASIC SAFETY RULES.)

TIGHTENING THE RECEIVER SCREWS

Receiver screws attach the lower receiver to the upper receiver (action). Tightness of the screws should be verified periodically. Tighten the receiver screws as follows (fig. 25):

1. Remove the tool compartment and the trigger unit.
2. Check the tightness of the receiver screws (A). In case the receiver screws are loose, they should be tightened to a torque of 15 Nm (133 in-lbs) with T25 Torx driver.

NOTICE

The rear receiver screw can only be tightened with the buttstock installed.

TRIGGER PULL WEIGHT ADJUSTMENT

WARNING

- The sear engagement, safety and other components of the action are precision mechanisms, which were properly adjusted at the factory. They should not be altered, modified or changed. Modifications to the firearm may decrease its safety and increase the risk of serious injury.
- For safety reason do NOT attempt to reduce trigger weight below 10 N (2.2 lbs).
- If the trigger, sear or safety catch must be replaced, the safety must be readjusted. For this operation the trigger mechanism must be returned to the manufacturer.

TRG 22/42 A1's two-stage trigger has been preadjusted at the factory and needs no adjustment. However, if you wish to alter the trigger pull weight, proceed as follows (fig. 26):

1. Remove the bolt and magazine.
2. By using a T10 Torx driver, turn the pull weight adjustment screw (B) clockwise to increase the weight or counter clockwise to decrease it. Adjust the pull weight between 1.2 and 2.1kg (2.6-4.6 lbs).

The adjustment screw is self locking, so do not use any locking compound. Pull weight has been factory set at 13-15 N (approx. 3 lbs) and can be adjusted between 1.2 and 2.1kg (2.6-4.6 lbs).

Adjusting the trigger pull weight adjusts both the first stage and second stage pull weights equally.

ADJUSTING THE TRIGGER LEVER

The trigger lever can be adjusted horizontally as well as rotated both vertically and horizontally. The trigger lever is adjusted as follows (Fig. 27):

1. Before adjusting the trigger position, loosen the fastening screw using a T10 Torx-key.
2. Set the trigger to the desired position.
3. Re-tighten the screw after adjustment and verify the functioning of the trigger.

CAUTION

Do not make any other adjustments to the trigger! If you notice any changes in operation of the trigger, please turn to an authorized gunsmith

BUTTSTOCK ADJUSTMENTS

FOLDING AND UNFOLDING THE STOCK

The buttstock can be folded as follows (Fig. 28):

1. Press the button (A) on the top of the pistol grip and simultaneously fold the rear stock to the side.
2. The stock locks securely to the folded position.

The folding stock is opened by pushing button (A) and folding the stock parallel to the rifle until it locks securely to the open position.

LENGTH OF PULL

The length of pull can be adjusted as follows (Fig. 29):

1. Press and hold the latch (A) in the rear of the stock either from the left or right side of the rifle.
2. The spring-loaded recoil pad assembly can be adjusted forward or rearward at 6 mm increments.
3. Release the latch and the recoil pad assembly locks into position.
4. The length of pull latch can be locked down by tightening a Torx T10 screw (A) inside the left and/or right side latch.

NOTICE

Make sure the locking of the latches are opened before attempting to readjust the recoil pad.

CHEEK PIECE HEIGHT

The height of the cheek piece is adjusted as follows (fig. 30):

1. Press latch (B) either on the left or right side of the rear stock below the cheek piece.
2. The spring-loaded cheek piece can be lowered or raised to the desired position in 3mm increments.
3. The height adjustment latch can be locked down by tightening a Torx T10screw (A) inside the left and/or right side latch.

NOTICE

Make sure the locking of the latches are opened before attempting to readjust the cheek piece.

RECOIL PAD HEIGHT

The height of the recoil pad is adjusted as follows (fig. 31):

1. Press and hold button (A) located on the left side of the rear stock.
2. Slide the recoil pad assembly up or down to the desired position at 7.2mm increments.
3. Release the button (A) to lock the recoil pad assembly in its position.

The push button can optionally be reversed to the right side of the rifle. Moreover, adjustment travel can be changed further to four different ranges as follows:

1. Remove the rubber recoil pad by removing the two rear screws (Torx T25).
2. Remove T25 Torx screw located on the middle of the aluminium plate.
3. You can choose between two different attachment options both on the plate and on the button side.

CHANGING PISTOL GRIP REAR SECTION

The pistol grip rear section can be changed as follows (fig. 32):

1. Fold the rear stock in order to reach to the locking screw under the pistol grip.
2. Loosen the locking screw 2-3- turns with a T10 Torx-key.
3. Remove the pistol grip rear section by pulling out the bottom part first.

The pistol grip rear part section is attached in reverse order starting from the top end. Once the rear part is completely in place it is secured by tightening the locking screw with a T10 Torx-key. Excessive torque should be avoided.

There are three different sizes, Small, Medium (factory setup) and Large.

SLING SWIVEL ATTACHMENT POINTS

TRG 22/42 A1 is equipped with the following sling swivel attachment points:

- In the rear part of the weapon a sling can be attached on either side of the folding stock or on top of the hinge using a QD sling socket (A, fig. 33) or a MIL-sling lug (B, fig. 33).
- In the front, a sling attachment can be attached in the M-LOK interface (fig. 34). The sling attachment has a QD sling socket (A) and a MIL-sling lug (B).

PICATINNY RAIL ATTACHMENT

The SAKO TRG 22/42 A1 handguard can be equipped with an M-LOK interface picatinny rail. Attach the rail on the M-LOK interface by positioning the rail on the M-LOK slots and then tightening the attachment screws (fig. 36).

BIPOD ATTACHMENT (IF EQUIPPED)

The SAKO TRG 22/42 A1 can be equipped with a bipod attached on the handguard on the M-LOK interface or to a separately attached picatinny rail.

MUZZLE BRAKE OR SUPPRESSOR ATTACHMENT (if applicable)

TRG 22/42 A1 has been equipped with threaded muzzle (M18x1) which enables muzzle brake/suppressor (optional) attachment. Follow the instructions provided by the muzzle brake/suppressor manufacturer for attachment, use and maintenance.

Sako TRG Muzzle Brake (M18x1) is attached as follows (fig. 35):

1. Remove the muzzle thread protector by turning it counterclockwise.
2. Attach the muzzle brake to the barrel and rotate it clockwise until it reaches the end of the thread.
3. Turn the muzzle brake slightly counterclockwise until it is positioned correctly. TRG Muzzle Brake is correctly positioned when the gas ports are positioned to the sides and the mirage strap fitting screw (A) is pointing upwards.
4. Tighten the fastening screw (B) to 10 Nm torque.

If the rifle tends to kick aside when shooting, this tendency can be decreased by inclining the muzzle brake openings in the direction of the kick. Reverse the procedure to remove the muzzle brake.

General suppressor attachment:

1. Remove the muzzle thread protector by turning it counterclockwise.
2. Screw the suppressor on the muzzle threads and tighten moderately. Overtightening may result in excess group shift or loss of accuracy.

Check sighting in after muzzle brake/suppressor attachment and adjust if necessary.

When not using a muzzle brake or suppressor, you should always keep the muzzle thread protector sleeve installed.

⚠ CAUTION

Remember to remove the suppressor from the barrel right after shooting. Moisture evaporating from the suppressor can cause corrosion of the bore.

⚠ CAUTION

Use of muzzle brake or sound suppressor may be prohibited in some countries. Always follow the national legislation and regulations concerning the use of muzzle brake or suppressor.

REAR SUPPORT (if applicable)

The rear support is attached as follows (fig. 37):

1. Extend the recoil pad to its rearmost position.
2. Remove the rear hook.
3. Make sure that the fastening screw (A) is sufficiently loosened. Then, attach the rear support to the front part of the picatinny rail as illustrated.
4. Tighten the fastening screw (A) with a Torx T25 screwdriver.

The rear support locks when in uppermost position to prevent accidental opening (e.g. during transportation). To use

rear support, do the following (Fig. 37):

1. Press button (B) and pull the rear support slightly downwards to release the locking mechanism.
2. Push lever (D) downwards and move the rear support to desired position. Upon releasing the lever the rear support will positively lock in to the position where adjusted. Downward adjustment does not require pushing the lever.
3. Fine adjustment is done by rotating adjustment wheel (C).

NOTICE

If the rear support release button (B) feels stuck when the rear support is in the uppermost position, open the adjustment wheel (C) to release tension in the mechanism.

ROUTINE CLEANING AND MAINTENANCE

WARNING

- Always check that the rifle is unloaded (empty cartridge chamber, empty receiver, empty magazine). Inspect the firearm by looking through the ejection port and the chamber. If it is not empty, unload it as instructed in the relevant section. Check that the firing pin is decocked.
- Never point the firearm at someone or at hard, flat surfaces. Always treat the rifle as if it were loaded. (See points 1, 2 and 4 of the BASIC SAFETY RULES.)

Routine cleaning should always take place right after use of the rifle (even without shooting). Corrosion can begin within hours if the rifle is not cleaned after use. It is recommended to support the rifle with the bipod during cleaning. Use only high quality gun oil that cleans, lubricates and preserves (CLP). Routine cleaning procedure is done as follows:

1. Ensure that the rifle is unloaded and remove the bolt and magazine
2. In case the rifle has been used in wet conditions dry it using compressed air or let it dry in a warm / dry place without any protective cover i.e. drag bag.
3. Use an absolutely straight, sturdy and smooth cleaning rod fitted with bronze bore brush soaked in bore solvent and push-pull it through the bore until major residue is removed (approx. 10-15 times). It is recommended to use cleaning rod guide to prevent the rod from dragging on the inner surfaces of the bore and receiver.
4. Push a clean felt pellet moistened with cleaning solvent through the bore one after another until pellets come out clean (approx. 5-10 times). Clean only in the direction of bullet movement and replace dirty pellet with new before every cleaning sequence. Guide the cleaning rod with fingers or special bore guide.
5. Clean the inner surfaces of the receiver from all the firing residue with felt pellet and/or brush moistened with cleaning solvent.
6. Use a small solvent-wetted brush to clean the bolt from firing residue.
7. Use larger diameter nylon brush or particular chamber cleaning pellet moistened with bore solvent to clean the chamber.
8. Pass a regular bore pellet moistened with rust preventive oil through the bore. Also, leave a thin coat of oil on the cartridge chamber surface (remember to wipe it dry before shooting!).
9. Wipe all touching surfaces of the receiver and bolt with a very light coat of rust preventive oil.
10. Wipe the stock dry. Lightly oil all the metallic (not aluminium) parts in the stock.
11. Check the correct tightness of the receiver screws.

PERIODIC MAINTENANCE

WARNING

- Always check that the rifle is unloaded (empty cartridge chamber, empty receiver, empty magazine). Inspect the firearm by looking through the ejection port and the chamber. If it is not empty, unload it as instructed in the relevant section. Check that the firing pin is decocked.
- Never point the firearm at someone or at hard, flat surfaces. Always treat the rifle as if it were loaded. (See points 1, 2 and 4 of the BASIC SAFETY RULES.)

Periodic maintenance should be carried out at least once a year or more frequently under heavy use or in severe conditions. Moreover, periodic maintenance is recommended if the rifle is to be stored for prolonged period. If it is necessary to replace any parts, use only original factory spare parts. When loosening or tightening screws, ensure

that the tool is of appropriate size and shape. Poor tools will damage the screw heads and general appearance of the rifle. Use only high quality gun oil that cleans, lubricates and preserves (CLP).

Periodic maintenance is carried out as follows:

1. Carry out the routine cleaning and maintenance.
2. It is advisable to remove copper fouling from the bore. When examining the front part of the bore, slight residue from the bullet copper jacket might be seen. There are various solvents and mechanical cleaners for this purpose, and we recommend that the instructions given by their manufacturers are followed. Badly fouled barrels can shoot inaccurately and will corrode much easier than carefully cleaned ones.
3. Wipe the rifle clean from dust, dirt etc. and lubricate all metal surfaces with a lubricated rag so that a light film of lubricant remains on the rifle.
4. Lubricate the sling swivel mounts and inspect their attachment to the rifle.
5. Disassemble the bolt as instructed in the manual, clean the dirt with solvent-wetted brush and lightly lubricate surfaces with protective oil. Lightly grease the locking lug surfaces (D, fig. 11), camming slope (C) and head of the cocking piece (B).
6. Assemble the bolt and check the function of different parts (including extractors and ejectors).
7. Check the attachment of the sights and scope.
8. Clean muzzle brake and other accessories and lubricate them if needed.
9. Check tightness of all screws including stock and receiver screws.
10. Assemble the gun and check the functionality of components.

STORAGE

Always store your firearm in a secure, dry place, where it will not be damaged and where children and unauthorized persons cannot gain access to it. Keep cartridges separately in a secure place. Before storage, always check the condition of the rifle and ensure that it is perfectly dry. Moreover, remember to remove the suppressor from the barrel (if fitted) before storage. Moisture and water drops can damage the rifle.

NOTICE

Always follow the national legislation and regulations concerning the storage of the firearm. Rules depend on the country. Do not store the rifle in a leather or fabric case. These materials attract moisture, even though they may appear to be perfectly dry.

WARNING

To reduce the risk of accidents involving children or unauthorised persons, keep your firearm locked away and store the ammunition in a separate locked location!

OPERATIONAL CHANGES OR DAMAGES

If you notice any changes in the functioning of your firearm, STOP SHOOTING IMMEDIATELY! You should take the rifle to an authorized gunsmith or ship it to the manufacturer/importer if you experience any occurrences similar to the following: the functioning of the trigger mechanism has changed, the rifle does not fire the cartridge (misfires), the safety does not operate, there is any cartridge malfunction (spitting gas, a punctured primer, a bulged or ruptured case) or a changed sound when firing.

WARNING

If the rifle doesn't fire after pulling the trigger, engage the safety, wait at least one minute and unload the rifle with extreme care as described in the corresponding section.

If the rifle is damaged while shooting, send your rifle to the dealer/importer and include:

- An explanation of what has happened.
- The cartridge case (with which the damage occurred).
- Preferably a sample of the cartridges.

In these circumstances do not dismantle the rifle. Never ship a loaded firearm.

WARRANTY

All Sako rifles have a 2-year limited warranty. The products are guaranteed against possible defects in material or workmanship. In case of defect, please turn to the nearest Sako dealer. Please refer to the Terms & Conditions on the Sako website at: www.sako.fi.

TECHNICAL DATA

	TRG 22 A1	TRG 42 A1
Caliber / Rate of twist (in)	308 Win / 11" 260 Rem / 8" 6.5 Creedmoor / 8"	300 Win Mag / 11" 338 Lapua Mag / 10"
Weight without accessories	5.3-5.7kg (11.7-12.6lbs)	6kg (13.2lbs)
Overall length / Barrel length	1005mm (39.6") / 510mm (20") 1153mm (45.4") / 660mm (26")	1204mm (47.4") / 690mm (27") barrel
Bolt lift angle	60°	60°
Muzzle thread	M18x1	M18x1
Magazine capacity	308 Win 10 rounds 260 Rem 10 rounds 6.5 Creedmoor 10 rounds	300 Win Mag 7 rounds 338 Lapua Mag 5 rounds

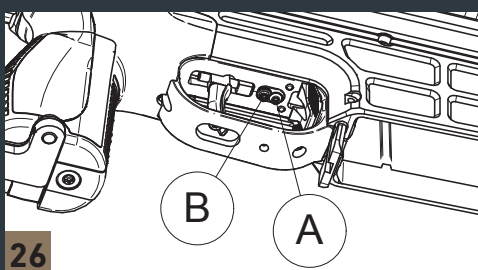
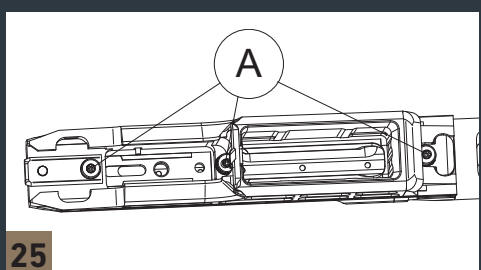
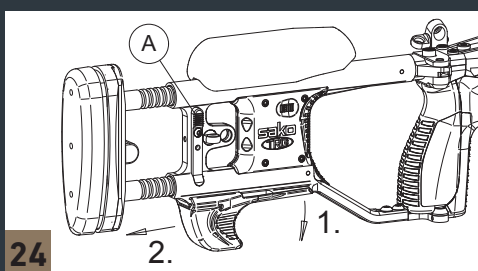
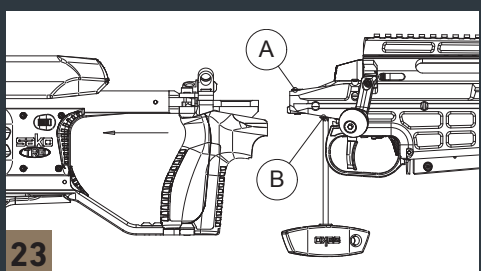
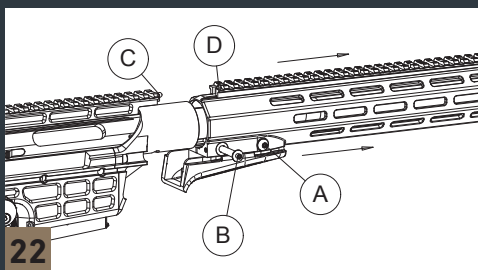
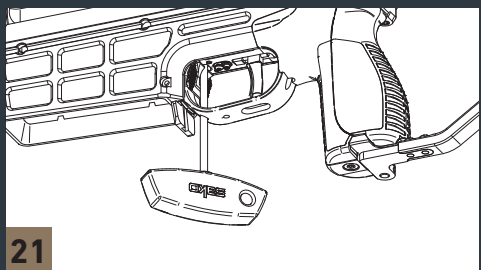
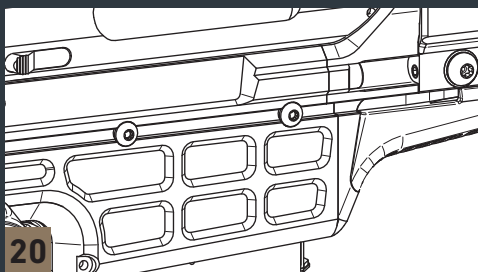
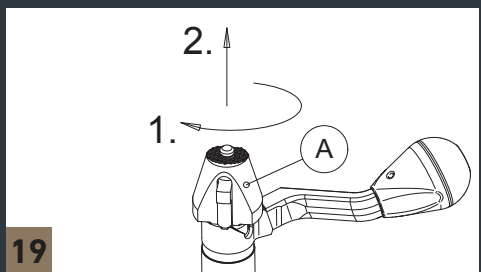
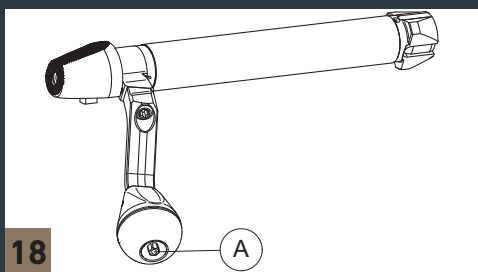
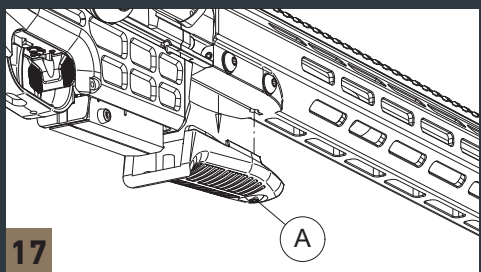

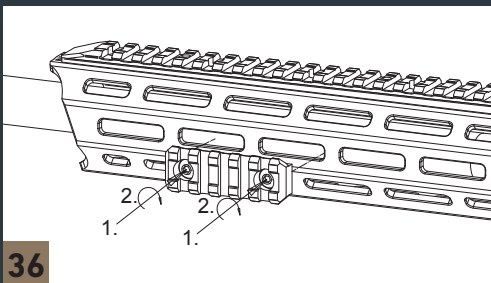
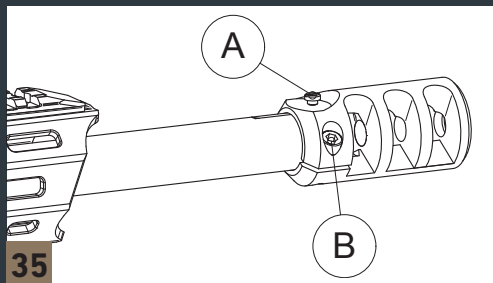
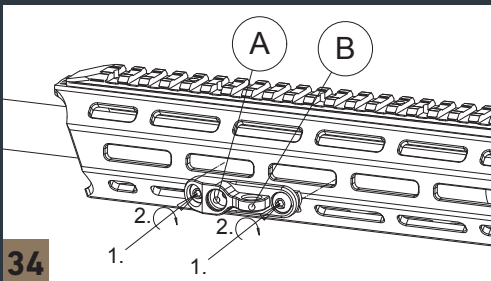
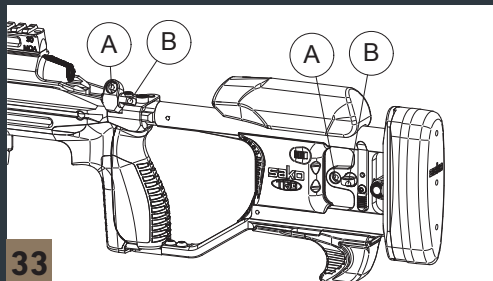
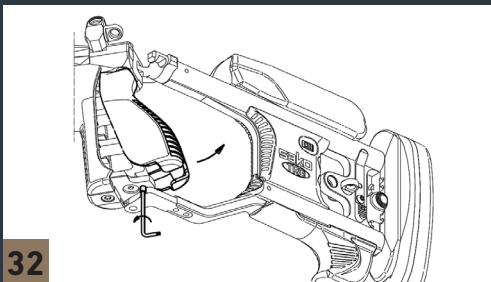
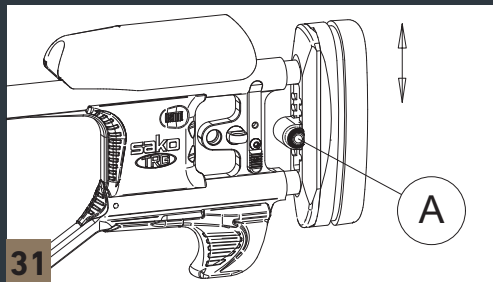
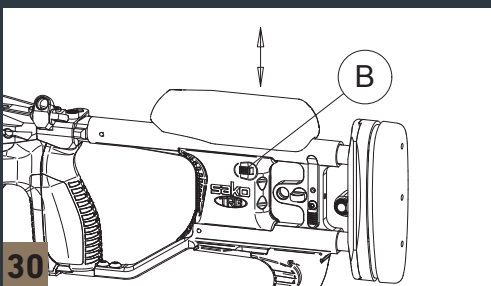
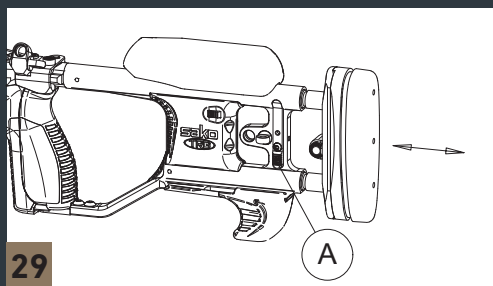
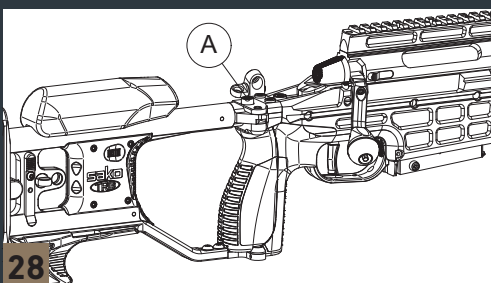
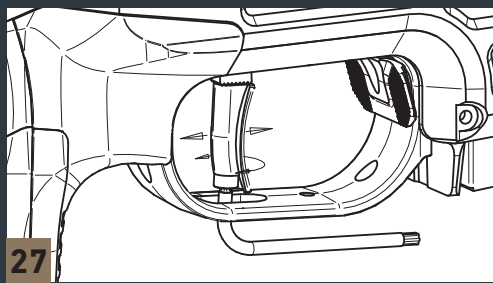

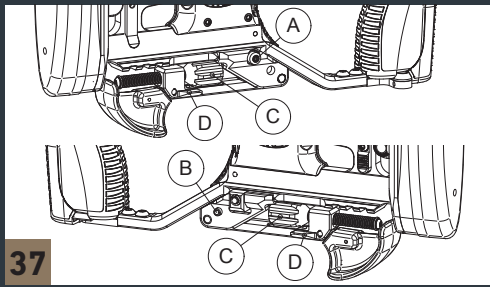

37

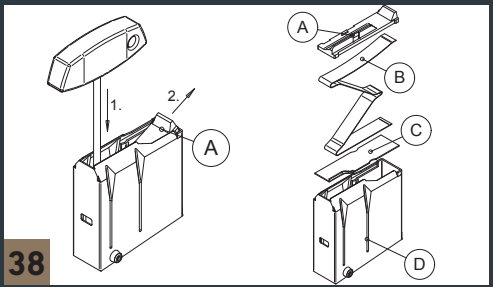

38

sako

A Beretta Group Company

SAKO LIMITED

P.o.box 149 | FI-11101 Riihimäki | Finland | www.sako.fi