

SIGSAUER®
when it counts®



P320®

SEMI-AUTOMATIC CO₂ PELLET PISTOL

OWNERS MANUAL: HANDLING & SAFETY INSTRUCTIONS

! WARNING

READ THE INSTRUCTIONS AND WARNINGS IN THIS MANUAL CAREFULLY BEFORE USING THIS CO₂ AIRGUN; DO NOT DISCARD THIS MANUAL. This instruction manual should always accompany this CO₂ airgun and be transferred with it upon ownership, or when the CO₂ airgun is loaned or presented to another person.

TABLE OF CONTENTS

1.0 Safety Rules	3
2.0 Description	4
3.0 How to Operate	5
4.0 Unloading the Ammunition	9
5.0 Removing Jammed Ammunition	9
6.0 Unloading Ammunition from Magazine	10
7.0 Troubleshooting	11
8.0 Safe Use and Handling of CO ₂ Cylinders	11
9.0 Storage	12
10.0 Repairs & Returns	13
11.0 Routine General Maintenance	14

⚠ WARNING - READ THIS OWNER'S MANUAL COMPLETELY.

This CO₂ airgun is not a toy. Treat it with the same respect you would a firearm. Always carefully follow the safety directions found in this owner's manual and keep this manual in a safe place for future use.

⚠ WARNING – Not a toy. Adult supervision required. Misuse or careless use may cause serious injury or death. May be dangerous up to 224 yards (205 meters).

This is a high powered CO₂ airgun intended for use by those 16 years of age or older. Read all instructions before using. It is the purchaser's/user's responsibility to conform to all laws governing use and ownership of CO₂ Airguns.

⚠ WARNING - AIRGUN SAFETY IS YOUR RESPONSIBILITY

This owner's manual is designed to assist you in learning how to properly use and care for your SIG SAUER CO₂ airgun. Only when you are certain that you fully understand this manual and can properly carry out its instructions, should you practice loading and firing your CO₂ Airgun with Pellets in the magazine. This product is not a toy. Having a CO₂ Airgun in your possession is a full-time job; you cannot guess and you cannot forget. You must know how to use your CO₂ Airgun safely. If you have any doubts about your ability to handle or use this CO₂ Airgun safely, you should seek supervised instruction.

1.0 SAFETY RULES

⚠ WARNING – Before using your new SIG SAUER CO₂ Airgun, you must take the time to read and understand the following safety rules:

- Do not install a magazine which contains ammunition into the gun until you are ready to shoot. If you do install a magazine which contains ammunition into the gun and then decide not to shoot, manually remove the magazine from the gun.
- An unloaded, non-pressurized gun with an “ACTIVATED” Safety is the safest condition in which to possess or store an CO₂ Airgun.
- Accidents happen fast, be cautious, shoot safe.
- Whenever you handle, transport, store, pressurize, or clean a SIG SAUER CO₂ Airgun, make sure the Safety is “ACTIVATED” and there is no ammunition in the magazine.
- Always use eye protection.
- Think first. Shoot second.
- Always point the CO₂ Airgun in a safe direction. Never point your CO₂ Airgun at people or animals even if it is not loaded.
- Always keep your fingers away from the trigger until you are ready to shoot.
- Always be certain of what is behind your target. Make sure your target does not conceal a person or some object which could be harmed by the pellets. Do not shoot at targets which allow ricochets or deflections.
- Do not shoot into or at water.
- Never use drugs or alcohol while handling this product.
- The CO₂ Airgun and pellets should be kept in separate and secured places.
- Do not walk, run, jump or climb when carrying a loaded CO₂ Airgun unless holstered. A loaded CO₂ Airgun should never be carried inside a vehicle.
- Never modify or alter your SIG SAUER CO₂ Airgun. Modification of the CO₂ Airgun may cause it to malfunction or make it unsafe and will void the warranty.

⚠ WARNING – Do not brandish or display this CO₂ Airgun in public. It may be confusing to people and may be a crime. Police and others may think this CO₂ Airgun is a firearm. Do not use or carry the CO₂ Airgun in situations where it could be mistaken for a firearm.

⚠ WARNING – Keep face away from the CO₂ cylinder when replacing the CO₂ Cylinder. Wear gloves. Escaping CO₂ gas can cause frostbite if it comes in contact with skin.

⚠ WARNING – Use only 12 gram CO₂ cylinders. Any attempt to use other types of gas cylinders could be extremely dangerous and could result in serious injury or death. Gases other than CO₂ could result in an explosion or rupture the Airgun.

2.0 DESCRIPTION





SIGSAUER
when it counts®

3.0 HOW TO OPERATE

⚠ WARNING – Be sure gun is always pointed in a safe direction. Never point the gun at anyone. Always assume and treat the gun as if it were loaded and ready to fire.

STEP 1. ACTIVATE SAFETY – POSITION SAFETY SO RED DOT IS NOT SHOWING.

The P320® model has a striker fire internal hammer system. No decocker needed. In order to ACTIVATE safety, slide the button to the rear of the Pistol (A).

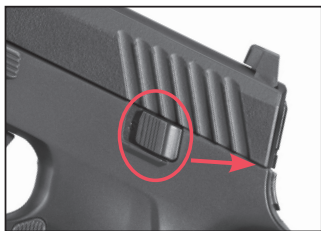

(A) SAFE



STEP 2. INSERT 12 GRAM CO₂ CYLINDER



⚠ WARNING – If you are not going to use the CO₂ cylinder for a long period of time, remove the CO₂ cylinder.

When replacing the CO₂ cylinder, it is possible that some residual gas is left in the cylinder. In order to avoid accidents, make sure that the pistol is unloaded and the safety is "ACTIVATED" when removing or placing a CO₂ cylinder. Never use force to insert a CO₂ cylinder.

Keep the CO₂ cylinder away from heat and flames. Temperatures over 120° F (50° C) can cause explosion and injury. Never throw a CO₂ cylinder into a fire.

Always wear eye protection when handling CO₂ cylinder, since there is a risk of injury to the eyes. Do not remove a CO₂ cylinder until it is completely empty. Failure to observe this recommendation can result in a dangerous escape of residual gas. (Refer to: USE AND HANDLING OF CO₂ CYLINDERS section for further instructions)

STEP 3. LOAD THE MAGAZINE - Use .177 Caliber Pellets Only.

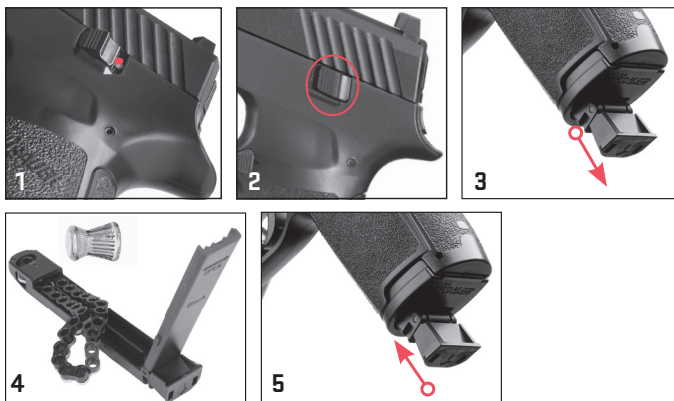

⚠ WARNING - For use with .177 Cal pellets only. Do not reuse pellets.

⚠ WARNING - When storing the CO₂ airgun, point the barrel at the ground and make sure that the magazine is empty and that there are no pellets in the barrel. In this way you are less likely to experience possible accidents when using the CO₂ airgun again.

⚠ WARNING - When there is an obstruction in the barrel, never shoot another pellet. Always make sure that the Safety is activated and the CO₂ airgun is unpressurized before clearing an obstruction.

Always discard defective ammunition. We recommend SIG SAUER® ammunition for SIG SAUER CO₂ airguns. Never reuse pellets.

STEP 4. AIM AT A SAFE TARGET

To be a consistent marksman, use the correct sight picture each time you fire the pistol.

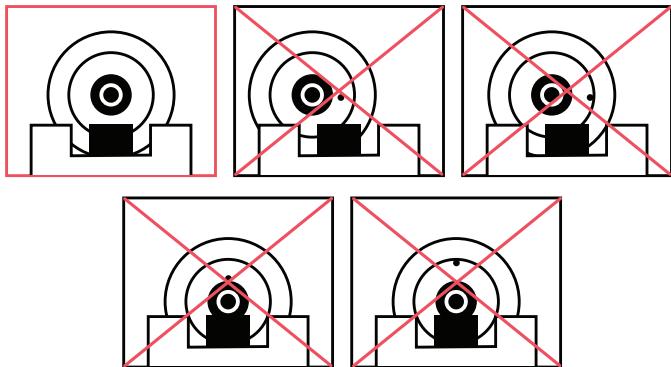

⚠ CAUTION – Due to the power of this gun, use extra precaution in selecting a safe target. Improper targets may cause ricochet.

STEP 5. FIRING SAFETY – POSITION SAFETY SO RED DOT IS SHOWING.

When you are certain the target, back stop and surrounding area is safe, deactivate Safety by sliding the lever to the front of the pistol so that **RED DOT IS SHOWING** (B). Pulling the trigger now will fire the gun. Fully release the trigger after every shot in order to cycle the next pellet into position. By not fully releasing the trigger (i.e. short stroke) the pellet will not advance completely and will result in a misfire.

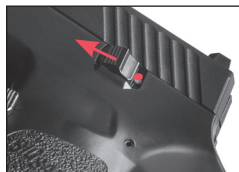

⚠ WARNING – BE AWARE of intended target and back stop/surrounding area.

(B) FIRE

⚠ WARNING – Use extreme caution in operating when gun is loaded, CO₂ inserted, and cocked, it is now ready to fire a pellet once the trigger is pulled. When the gun is fired the hammer will re-cock and the gun will be ready to fire again when the trigger is pulled. Keep gun pointed at a safe target.

STEP 6. ACTIVATING SAFETY - POSITION SAFETY SO RED DOT IS NOT SHOWING.

Remove magazine and return the Safety to the "ON" position – **NO RED DOT SHOWING** (figure C).



(C) SAFE



4.0 UNLOADING THE AMMUNITION

Keep the CO₂ airgun pointed in a SAFE DIRECTION. Remove the magazine. Fire at a SAFE target. Repeat until you are sure the CO₂ airgun no longer fires ammunition. You may also unload your CO₂ airgun by following the directions listed under "Removing Jammed Ammunition".

5.0 REMOVING JAMMED AMMUNITION

Keep the CO₂ airgun pointed in a safe direction. Remove the magazine. Remove the CO₂ cylinder. Insert a .177 caliber ramrod into the muzzle end and carefully push the jammed ammunition into the breech area and remove. If you are not able to unjam your CO₂ airgun, take no further action. Call SIG SAUER Customer Service at (603) 610-3000. **NOTE:** The barrel could be damaged and the warranty will be void if the proper sized ramrod or ammunition is NOT used.

⚠ WARNING – Make sure that the Safety is activated and the CO₂ cylinder has been removed before proceeding with the removal of ammunition. Before removing the CO₂ cylinder, make sure that it is empty of CO₂ by gently unscrewing the CO₂ cylinder and release the excess gas slowly and gradually.

6.0 UNLOADING AMMUNITION FROM MAGAZINE

1. **ACTIVATE SAFETY - NO RED DOT SHOWING.**
2. Remove Magazine by pressing Magazine release button.
3. Open magazine cover (D).
4. Rotate belt through its reel with finger to visually inspect for any ammunition still loaded in belt.
5. If shooter finds ammunition still loaded in belt, take a .177 caliber ramrod or object of similar size and fashion and gently push ammunition out of seated hole. (E) **BE SURE TO PUSH AMMUNITION OUT FROM REAR OF MAGAZINE THROUGH FRONT OF MAGAZINE TO AVOID DAMAGE TO SEATED HOLES.**
6. Rotate belt until all seats have been cleared and belt is empty.

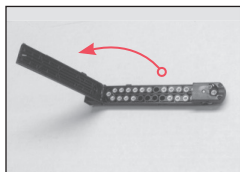

(D)



(E)



⚠ CAUTION – DO NOT assume the gun is empty of Pellets once the Pellets are removed from magazine. Verify that all Pellets are removed. Always treat the gun as if it were loaded and ready to fire.

⚠ CAUTION – If airgun is dropped, follow steps below for operation checks in troubleshooting and if gun does not function follow steps for repair and return.

7.0 TROUBLESHOOTING

PELLET DOES NOT FIRE:

⚠ WARNING – If a pellet does not fire after completing the operation steps, do not assume that the gun is unloaded. Keep the gun pointed in a safe direction.

MAKE THE FOLLOWING CHECKS IF PELLET DOES NOT FIRE:

1. Was the Safety deactivated (OFF) – **RED DOT SHOWING**, when the trigger was pulled? If Not, repeat the operation Steps.
2. Did the magazine contain .177 caliber pellets? If not, activate Safety – NO RED DOT SHOWING, fill the magazine with appropriate ammunition and repeat the operation Steps.
3. Was a CO₂ cylinder installed? If not, activate Safety – NO RED DOT SHOWING, and insert a new CO₂ cylinder by way repeating all operation Steps. Refer to the section on CO₂ characteristics.
4. If the pistol still does not fire. Refer to the warning below.

⚠ WARNING – If the pistol still fails to shoot a pellet after checking the four items above, there may be a malfunction in the pistol. This could represent a dangerous condition. There could be pellets lodged in the pistol even though a pellet did not shoot out. Always treat the gun as if it were loaded. At no time should one look down the barrel of the gun. Activate safety – no red dot showing. Remove the CO₂ cylinder and send the pistol directly to sig sauer manufacturing services department (refer to section on repairs).

8.0 SAFE USE & HANDLING OF CO₂ CYLINDERS

It is possible that certain conditions may affect a CO₂ cylinder, which can impact its proper performance. These conditions include the usage, maintenance and storage at temperatures that are higher or lower than (59°F/15°C to 69.8°F/21°C). Rapid firing of the CO₂ airgun can affect the performance of the CO₂ cylinder as well.

1. High temperatures can increase pressure in the CO₂ cylinder and also within the gun, leading to higher than standard operating pressure. This excess pressure could cause the gun to malfunction or be permanently damaged. Maximum

storage or operation temperature should never exceed 122°F (50°C). This temperature can be reached if you leave the gun under direct sunlight on a bright day. Thus, to ensure proper gun operation, do not expose it or CO₂ cylinders to high temperatures or direct sunlight for long periods of time. Otherwise, the CO₂ cylinder could overheat and explode, which may could damage the airgun and cause injuries or death to people around it.

2. Fast consecutive shooting may produce a decrease of temperature in the gun, as well as the CO₂ cylinder. This could result in lower projectile velocities and may even lower gas pressure enough so that the pistol will not fire. This condition can be especially apparent when shooting in cold weather and can be avoided by allowing more time between shots. This permits the gas to increase in temperature and pressure and produce normal velocities.
3. During rapid fire, the muzzle velocity of each shot will diminish. This can affect shooting accuracy and you will get fewer shots per CO₂ cylinder.
4. Care should be exercised to insure that the gun is not shot with a CO₂ cylinder that is low in pressure. Here are some indicators of insufficient pressure:
 - A) The sound of the shot is not as loud as when the cylinder is full.
 - B) Reduced pellet velocity, which may be signaled by the pellet hitting the target, but in a lower position than it would with a full CO₂ cylinder (That is the shooting speed has dropped).

9.0 STORAGE

- Before storing the CO₂ airgun, make sure the safety is "ACTIVATED", the magazine is unloaded, and the CO₂ is removed.
- CO₂ airguns should be stored in such a manner as to protect against unauthorized use by children and others.
- These products are designed to look, handle and function like firearms. These products should be stored in such a manner to protect against theft and subsequent misuse.

10.0 REPAIRS & RETURNS

A CO₂ air gun that is not functioning well can be dangerous. Do not attempt to repair the gun yourself, since this may cause abnormalities in its functioning. Use the appropriate caliber cleaning rod (.177/4.5mm, .22/5.5mm) if a pellet has become blocked in the barrel. Take no further action if it can not be removed. Call SIG SAUER® Customer Service at (603) 610-3000. In the event you need to return your CO₂ airgun to the SIG SAUER Service Department, here's what to do:

1. First contact Customer Service at (603) 610-3000 for a Return Merchandise Authorization (RMA) number, which will allow SIG SAUER to track the status of your return from its receipt at SIG SAUER through its return to you. Please do not send your CO₂ airgun until you obtain an RMA number.
2. Make sure that the magazine(s) are unloaded and that no pellet is included with your returned CO₂ airgun.
3. Make sure the CO₂ cylinder is removed from the CO₂ airgun.
4. Package the CO₂ airgun securely to prevent damage. Enclose a letter that includes your name, street address, daytime phone number, model and serial number, and a detailed description of the problem you have experienced or the work you want performed. With the exception of extra magazines, do not include any other accessories such as scopes or mounts, or CO₂ cylinder.
5. SIG SAUER is not responsible for any CO₂ airgun until it is received, nor for damage incurred during shipment.
6. Ship your CO₂ airguns insured and prepaid (we do not accept collect shipments) to:

SIG SAUER, Inc. Attention: Service Department
18 Industrial Drive, Exeter, NH 03833

Don't forget to write your RMA number on the package.

11.0 ROUTINE GENERAL MAINTENANCE

- Always visually inspect Airgun before use. Function check all levers and buttons, such as magazine catch, Safety levers, slide catch lever, etc. before use of Airgun.
- Be sure sights and/or optics are not loose. If secondary sights/optic are mounted, be sure to follow instructions provided with that product.
- **DO NOT MODIFY OR ALTER YOUR AIRGUN.** Modification of the gun mechanism may cause a gun to malfunction and tampering with a gun may make it unsafe to use; ANY change in the performance, indicates possible wear and such guns should be inspected, replaced, or properly repaired. Repairs should only be made by qualified personnel. For non-voidance of warranty, replacements or returns are to be carried out and discussed with Sig Sauer™ customer service.
- If airgun is dropped, visually check to see that it works properly before you use it again. If any questionable changes, such as lowered trigger force and/or shortened trigger travel occurs, this may mean worn out or broken parts. Call SIG SAUER® customer service department at (603) 610-3000 for assistance before using your airgun again.

IF YOU DO NOT UNDERSTAND THE INSTRUCTIONS FOR OPERATING YOUR CO₂ AIRGUN, IT IS YOUR RESPONSIBILITY TO CALL OUR CUSTOMER SERVICE DEPARTMENT AT (603) 610-3000 BEFORE USING YOUR CO₂ AIRGUN.



SIG SAUER AIRSOFT/AIR GUN/AIR ACCESSORY LIMITED WARRANTY

SIG SAUER warrants that the enclosed AIRSOFT/AIRGUN/AIR ACCESSORY product was originally manufactured free of defects in material, workmanship, and mechanical function. For the applicable periods listed below, SIG SAUER agrees to correct any defect in the product for the original purchaser by repair, adjustment, or replacement, at SIG SAUER's option, with the same or comparable quality components (or by replacing the product at SIG SAUER's option); provided however, that the product is returned unloaded and freight prepaid to SIG SAUER at 18 Industrial Drive, Exeter, NH, 03833.

Limited Warranty Applicable Periods:

- SIG SAUER® AIR ONE Airsoft Models – Thirty (30) days from date of purchase
- SIG SAUER® PROFORCE Airsoft Models – Ninety (90) days from date of purchase
- SIG SAUER® AIRGUN Models (non-HUNTER models) – One-hundred and eighty (180) days from date of purchase
- SIG SAUER® HUNTER AIRGUN Models – One (1) year from date of purchase
- SIG SAUER® AIR ACCESSORIES – Sixty (60) days from date of purchase

Proof of purchase will be required with any request for warranty repair. This limited warranty is null and void if the product has been misused, damaged (by accident or otherwise), fired with improper ammunition, fired with an obstruction in the barrel, damaged through failure to provide reasonable and necessary maintenance as described in the manual accompanying the product, or if unauthorized repair or any alteration, including of a cosmetic nature, has been performed on the product. This limited warranty does not apply to normal wear and tear of any parts.



Subject to the foregoing, this limited warranty confers the right to have the covered product or its parts repaired, adjusted, or replaced exclusively upon the original purchaser, which right is not transferable to any other person.

ANY WARRANTIES IMPLIED BY LAW, INCLUDING ANY IMPLIED WARRANTIES OF MERCHANTABILITY OR FITNESS FOR A PARTICULAR PURPOSE, ARE EXPRESSLY DISCLAIMED. REPAIR, ALTERATION, OR REPLACEMENT AS PROVIDED HEREIN IS YOUR EXCLUSIVE REMEDY FOR ANY DEFECTIVE PRODUCT. IN NO EVENT SHALL SIG SAUER OR ANY COMPANY AFFILIATED WITH SIG SAUER BE LIABLE FOR ANY SPECIAL, INCIDENTAL, OR CONSEQUENTIAL DAMAGES OF ANY KIND ARISING OUT OF THE PURCHASE OR USE OF THIS PRODUCT, WHETHER BASED UPON CONTRACT, TORT, STATUTE, OR OTHERWISE. Some states do not allow the exclusion or limitation of implied warranties, or the exclusion or limitation of incidental or consequential damages, so some or all of the above limitations or exclusions may not apply to you. This warranty gives you specific legal rights, and you may also have other rights which vary from State to State.

THIS WARRANTY APPLIES TO U.S. COMMERCIAL CUSTOMERS ONLY, AND DOES NOT APPLY TO GOVERNMENT, MILITARY, LAW ENFORCEMENT, OR NON-US CUSTOMERS. NON-US CUSTOMERS SHOULD CONTACT THEIR LOCAL DEALER OR DISTRIBUTOR FOR APPLICABLE WARRANTY COVERAGE.



SIG SAUER®
when it counts®

**FOR PRODUCT SERVICE ON THIS MODEL,
PLEASE CALL (603) 610-3000 EXT. 1**

72 Pease Boulevard, Newington, NH 03801 USA