

BATTERY INFORMATION & WARNING

Before replacing batteries, read the enclosed BATTERY INFORMATION/WARNING insert in your original packaging. For additional battery safety, handling, and product information, visit www.surefire.com/batteries.

MAINTENANCE

Use a clean, dry cloth to wipe off body and window. Periodically clean and lubricate threads. Apply a thin coat of non-migrating, silicon-based lubricant to O-rings (do not use petroleum-based lubricants which can harm O-rings). For additional tips on maintaining your SureFire illumination tool, visit www.surefire.com/faqs-maintenance.

ACCESSORIES

SureFire makes a full line of accessories for most of its illumination tools. For a complete listing, visit www.surefire.com/partsaccessories.

THE SUREFIRE NO-HASSLE GUARANTEE

We'll do what it takes to keep your SureFire gear running smoothly. SureFire warrants that if you — our customer — purchase one of our products, and we determine that it is defective in material and/or workmanship during your lifetime, we will repair or replace it — no hassle!

Our warranty does not cover consumables or normal wear-and-tear — things like batteries draining, headbands and headpads wearing out, ink cartridges running out, and switches wearing out — or damage resulting from abuse, alterations, unauthorized repairs, or use contrary to SureFire's user manuals.

Should you need a replacement product, SureFire reserves the right to replace an obsolete product with a current production, like model. In the event that any issue with a SureFire product is not covered under this warranty SureFire can arrange to have the product repaired for a reasonable fee.

STANDARD DISCLAIMER

Except as specified above or prohibited by applicable law: all express or implied conditions and warranties, including, without limitation, any implied warranty or condition of merchantability or fitness for a particular purpose, or accuracy of any informational content, are hereby excluded and disclaimed by SureFire; and in no event will SureFire be liable for any special, direct, indirect, consequential, incidental or punitive damages howsoever arising and regardless of the theory of liability, even if advised of the possibility of such damages. Products, prices, availability, specifications, and offers are subject to change or cancellation at any time without notice.

WARRANTY CLAIMS

For claims, contact Customer Service at 714-545-9444 to obtain a Return Merchandise Authorization number (RMA#). Then package the unit carefully and send to (no CODs):

SureFire, LLC.
Repairs Department, RMA# _____
17680 Newhope Street, Suite B
Fountain Valley, CA 92708

SureFire will pay any reasonable shipping costs to return the unit to you.

Revision D 2-2021
71-01-1052



18300 MT. BALDY CIRCLE,
FOUNTAIN VALLEY, CA 92708-6122
SUREFIRE.COM



SCOUT LIGHT® USER MANUAL

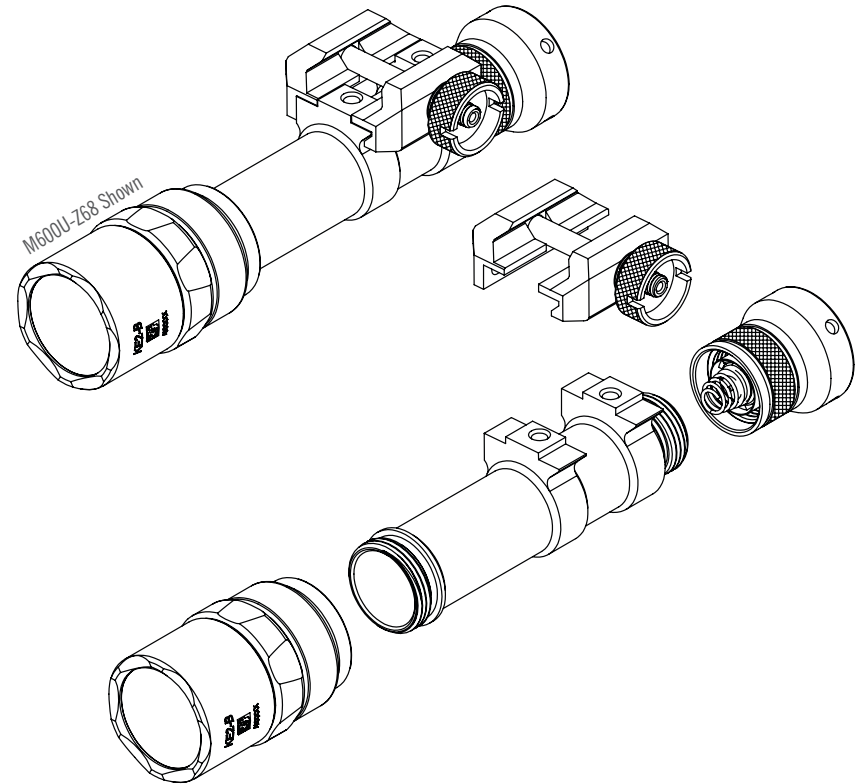

SPECIFICATIONS	KE1-H	KE2-B	KX1B	KE2-DF	KM1-E	KM2-C
OUTPUT	500 lumens	1,000 lumens	High: 600 lumens Low: 100 lumens	18650: 1,500 lumens 123A: 1,200 lumens	WH: 250 lumens IR: 100 mW	WH: 350 lumens IR: 120 mW
RUNTIME	1.0 hours	1.25 hours	High: 1.5 hours Low: 5 hours	18650: 1.5 hours 123A: 1.25 hours	WH: 1.5 hours IR: 6 hours	WH: 2.5 hours IR: 16.75 hours
PEAK BEAM INTENSITY	7,600 candela	11,300 candela	14,750 candela	18650: 16,000 candela 123A: 12,800 candela	9,300 candela	12,750 candela
DISTANCE	175 meters	213 meters	243 meters	18650: 250 meters 123A: 220 meters	190 meters	225 meters
BEZEL DIAMETER	1.125 in (2.9 cm)	1.125 in (2.9 cm)	1.37 in (3.48 cm)	1.125 in (2.9 cm)	1.06 in (2.7 cm)	1.06 in (2.7 cm)
CONSTRUCTION	Aluminum					
FINISH	Hard Anodized (MIL-A-8625 Type III, Class 2)					

All performance claims tested to ANSI/NEMA FL1-2019 Standard.

MOUNTING TO WEAPON

M75: Unscrew mount nut, position onto weapon, tighten nut until hand tight and then use a flat tool in the slot to tighten another 1/4 turn. Do not overtighten

RM45: Use a flathead screwdriver to tighten or loosen mount screw

M-AD-SF:

1. Press lock button to unlock the mount and open the lever 180°
2. Place WeaponLight onto the handguard and close the lever
3. The correct amount of tension is when only one hand is needed to swing the level closed
4. To adjust lever tension, open the lever and push the lever towards the base. The nut will protrude on the opposite side. Turn the nut right or left one to two flats per time to make the necessary adjustment and retest the tension

BATTERY INSTALLATION

1. Remove the LED head by unscrewing it counterclockwise and remove depleted battery(ies)
2. Insert fresh battery(ies) with the positive (+) terminal(s) facing forward toward the head

WARNING: Do not mix depleted and new batteries

3. Screw LED head back on clockwise until hand tight

LIGHT OPERATION

REMOTE TAPE SWITCHES

ST07: Press pressure pad for momentary activation

SR07: Press pressure pad for momentary activation; click pushbutton for constant-on

SR07-D-IT: Press pressure pad with bump to activate Weapon Light
Press pressure pad w/o bump to activate auxiliary device

SWITCH HOUSING

Z68: Partially press for momentary activation; click for constant-on

UE: Requires remote tape switch

DS Style: Partially press for momentary activation; click for constant-on. If a pressure pad is installed, see applicable instructions below

MULTI-SPECTRUM OUTPUT SELECTION (KM1/KM2)

Rotate bezel selector ring clockwise to select white-light or counterclockwise to select infrared

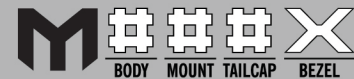

EXAMPLE

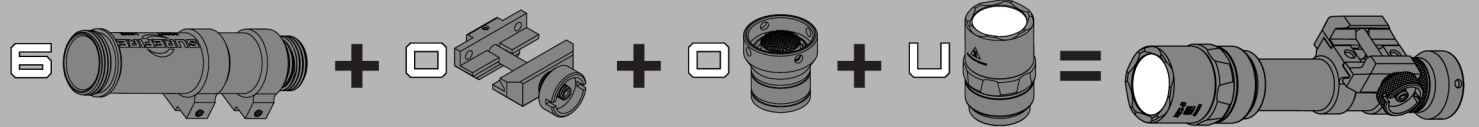

*Not all configurable model numbers may be released as products available for purchase. Go to www.surefire.com to inquire about released models

BODY SELECTION

- 3:** MH30 = (1) 123A BATTERY
- 6:** MH60 = (2) 123A BATTERIES
- 6:** MH60DF = (2) 123A BATTERIES (1) 18650



MOUNT SELECTION

- 0:** M75 (THUMBSCREW)
- 1:** RM45 (OFFSET)
- 2:** M-AD-SF (QUICK RELEASE)

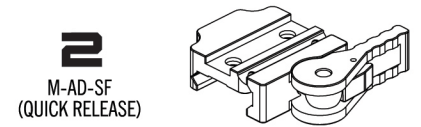
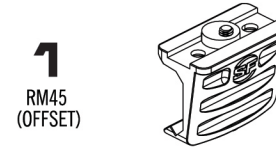
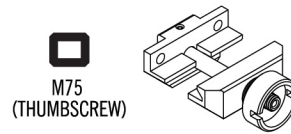

TAILCAP SELECTION

- 0:** Z68
- 1:** UE + ST07=UE07
- 2:** DS00 + ST07=DS07
- 3:** DS00 + SR07-D-IT=DS-SR07-D-IT
- 4:** DS00 + SR07=DS-SR07
- 5:** UE + SR07-D-IT=UE-SR07-D-IT
- 6:** UE + SR07=UE-SR07

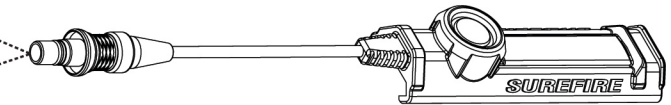
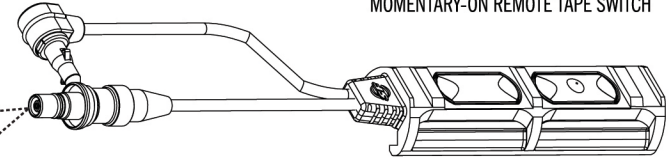
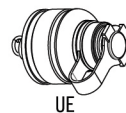
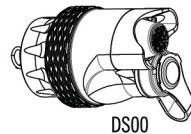

BEZEL SELECTION

- C:** WHITE (3V ONLY)
- U:** WHITE (6V ONLY)
- V:** INFRARED / WHITE (3V/6V)
- IB:** INTELLIBEAM (6V ONLY)
- DF:** WHITE (6V ONLY)

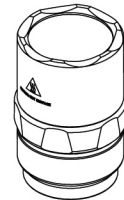

C
KE1-H
WHITE LED
(MH30 BODY ONLY)

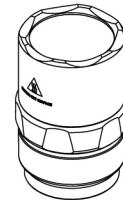

U
KE2-B
WHITE LED
(MH60 BODY ONLY)

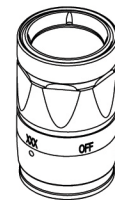

V
KM1-E
INFRARED / WHITE LED
(MH30 BODY ONLY)

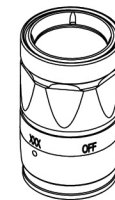

V
KM2-C
INFRARED / WHITE LED
(MH60 BODY ONLY)

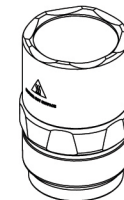

DF
KE2-DF
WHITE LED
(MH60DF BODY ONLY)

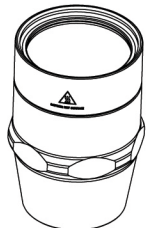

IB
KXIB
INTELLIBEAM / WHITE LED
(MH60 BODY ONLY)

WARNING

ALWAYS confirm weapon is unloaded and on SAFE before attempting installation.

WARNING

Use of substandard batteries can cause injury or property damage. Visit www.surefire.com/batterysafety.