



SAFETY & INSTRUCTION MANUAL FOR TRADITIONS® PURSUIT™ XT



⚠ WARNING: YOU MUST READ THESE INSTRUCTIONS AND WARNINGS CAREFULLY. FAILURE TO READ THESE INSTRUCTIONS AND FOLLOW THESE WARNINGS MAY RESULT IN SERIOUS INJURY OR DEATH TO YOU AND OTHERS AND DAMAGE TO PROPERTY.

⚠ WARNING: Black Powder or an approved black powder substitute are the only propellant powders that are safe to use in this muzzleloading firearm.

This manual may not be reproduced in whole or in part without the express written permission of Traditions® Performance Firearms.

Traditions® Performance Firearms
1375 Boston Post Road
P.O. Box 776
Old Saybrook, CT 06475
(860) 388-4656
www.traditionsfirearms.com

FIT-77

01-21 AKH

Your Muzzleloading Rifle

Congratulations on your purchase of a Traditions® muzzleloader. You have selected a muzzleloading firearm designed and engineered to give today's shooters the highest performance and optimum accuracy. When given the respect and care that any firearm demands, you can expect many years of reliable service and enjoyable hunting from your new Traditions® muzzleloader.

The Sport of Muzzleloading

More and more sportsmen have discovered the challenge and enjoyment of muzzleloading in recent years. For both hunting and target shooting, muzzleloading firearms have helped a modern generation recapture and enjoy an important aspect of our nation's sporting past. Traditions® muzzleloaders represent the latest developments in this unique part of the shooting sports. They are manufactured to modern standards for safe and enjoyable shooting. This booklet is intended as a basic guide for the proper maintenance, loading and shooting of Traditions® muzzleloaders, and it offers important rules and precautions for safe handling and shooting of this type of firearm. In addition to this booklet, it is recommended that the novice obtain further information and instruction before firing a muzzleloader.

Sources for this help include:

1. National Rifle Association <https://home.nra.org/>
2. National Muzzleloading Rifle Association
3. Local sporting goods dealer, State DEP, or conservation department
4. Local muzzleloader or hunting club
5. National Shooting Sports Foundation
<https://www.nssf.org/>

 **DANGER:** Always keep your firearm pointed in a safe direction with your finger off the trigger until you are ready to fire. Never point a firearm at anything you do not intend to shoot and always be sure of what is beyond your target.

This SAFETY & INSTRUCTION MANUAL should always accompany this firearm and be transferred with it upon change of ownership or when the firearm is presented to another person.

If you don't have a manual, a printed copy is available free upon request by contacting Traditions® at the address below. A manual is also available via download at:

www.traditionsfirearms.com

BE SURE TO READ ANY ADDENDUMS THAT ARE INCLUDED IN THIS MANUAL AS THEY MAY PERTAIN TO YOUR MUZZLELOADER.

**• CUSTOMER SUPPORT •
Traditions® Performance Firearms
1375 Boston Post Road
P.O. Box 776
Old Saybrook, CT 06475
(860) 388-4656
www.traditionsfirearms.com**

TABLE OF CONTENTS

1. YOUR SAFETY RESPONSIBILITIES.....	5
2. SAFE STORAGE & TRANSPORTATION.....	10
3. SAFETY RULES FOR YOUR PURSUIT™ XT.....	12
4. BASICS OF THE PURSUIT™ XT.....	15
5. SAFETIES INCLUDED ON YOUR PURSUIT™ XT.....	19
6. ELITE XT™ SYSTEM.....	20
7. INITIAL CLEANING OF PURSUIT™ XT.....	21
8. BASIC EQUIPMENT FOR SHOOTING PURSUIT™ XT.....	23
9. PREPARING TO CHARGE THE PURSUIT™ XT.....	24
10. CHARGING THE PURSUIT™ XT.....	26
11. PRIMING YOUR PURSUIT™ XT.....	30
12. FIRING THE PURSUIT™ XT.....	31
13. DEPRIMING THE PURSUIT™ XT.....	32
14. MISFIRES & HANGFIRES.....	32
15. DECOCKING THE PURSUIT™ XT.....	34
16. UNLOADING THE PURSUIT™ XT.....	35
17. CLEANING & MAINTENANCE OF PURSUIT™ XT.....	36
18. DISASSEMBLY, DETAILED CLEANING, & REASSEMBLY.....	38
19. INFO ON POWDER OPTIONS.....	45
20. SUGGESTED LOADS FOR THE PURSUIT™ XT.....	49
21. SCOPE MOUNTING & SIGHTING IN.....	51
22. WARRANTY & SERVICE.....	53

If you still have questions after reading this manual completely, please contact our customer service department at 860-388-4656 or view our how-to videos at <https://www.traditionsfirearms.com> and <https://www.youtube.com/TraditionsFirearm>

1. YOUR SAFETY RESPONSIBILITIES

SAFETY IS YOUR NUMBER ONE RESPONSIBILITY!!!!

No matter if you are at home, in the field, at the range, or anywhere; your primary concern as a firearm owner must always be safety. You must always apply the following safety rules in every situation with any kind of firearm regardless of setting. If you feel unsure about any aspect of your firearm or its operation, please contact Traditions® before using it.

 WARNING: YOU MUST FOLLOW ALL OF THESE SAFETY RULES TO ENSURE THE SAFE USE OF YOUR FIREARM. THE FAILURE TO FOLLOW THE INSTRUCTIONS AND WARNINGS IN THIS MANUAL COULD CAUSE SERIOUS PERSONAL INJURY OR DEATH TO YOU OR OTHERS AND DAMAGE TO PROPERTY.

When you become a firearm owner, you take on a serious and demanding responsibility. How seriously you take this responsibility can be the difference between life and death. There is no excuse for reckless or abusive handling of your firearm. At all times you must handle your firearm with an intense respect for its power and potential danger.

 WARNING: YOU ARE RESPONSIBLE FOR THIS AND ALL YOUR FIREARMS AT ALL TIMES. In owning a firearm, you have a constant responsibility for your firearms' safety and security. You must always protect yourself and all others against injury or death from misuse of the firearm 24 hours a day, 7 days a week, 365 days a year. This responsibility is not something you can ever neglect.

 WARNING: ALWAYS BE SURE OF YOUR TARGET AND WHAT IS BEYOND IT. Always know where a bullet you fire will hit and shoot only where there is a safe back stop free of any obstructions. Bullets can bounce or ricochet off many surfaces like rocks or the surface of water and travel in unpredictable directions with considerable velocity creating dangerous situations. NEVER fire randomly into the sky.

 WARNING: NEVER SOLELY RELY ON MECHANICAL FEATURES SUCH AS A SAFETY. Mechanical features such as safeties can fail and should never be relied upon with disregard to proper safe firearms handling. Only by following the safe firearms-handling procedures in this manual will the safe use of your firearm be assured. You are responsible for always following these safe firearm handling rules. Mechanical safeties in firearms are aides in establishing a more convenient operating system but are never replacements for safe handling on the part of the shooter.

 **WARNING: ALWAYS WEAR EYE AND EAR PROTECTION THAT ARE SPECIFIED FOR USE WITH FIREARMS** every time you handle your firearm for loading, firing, cleaning, or maintenance. Make sure that all bystanders where you will be shooting are also wearing the proper eye and ear protection.

 **WARNING: ALWAYS HAVE ADEQUATE VENTILATION WHEN DISCHARGING A FIREARM.** Discharging a firearm in poorly ventilated areas, cleaning firearms, or handling ammunition and loading components may result in exposure to lead and other substances known to cause birth defects, reproductive harm, and other serious physical injuries. Review the warnings and labels for all ammunition, loading components, and cleaning products carefully. Wash hands thoroughly after exposure.

 **WARNING: NEVER ALLOW THIS FIREARM TO BE USED BY ANYONE WHO DOES NOT UNDERSTAND ITS SAFE OPERATION OR HAS NOT READ THIS MANUAL IN ITS ENTIRETY.**

 **WARNING: NEVER DISASSEMBLE YOUR FIREARM** beyond the instructions outlined in this manual. Improper disassembly or re-assembly of your firearm may create a dangerous situation which can lead to serious injury or death to you or others or also the destruction of property.

 **WARNING: NEVER MANIPULATE, ADJUST, OR ALTER ANY OF THE INTERNAL COMPONENTS OF YOUR FIREARM.** Improper manipulation or alteration of any internal component may affect the safety and reliability of your firearm and create a situation where serious injury or death could occur. In addition do not replace any of the parts in your rifle unless they are genuine Traditions® parts. The use of non-Traditions® parts will void all warranties. Any alteration or replacement of parts in your Traditions® firearm not performed by a qualified gunsmith using genuine Traditions® parts may cause death, personal injury, or property damage. NOTE: Altering the factory-standard mechanical function of your firearm will VOID your warranty and could lead to unsafe handling and function of the firearm.

 **WARNING! DO NOT DRILL HOLES IN THE BARREL AS THIS COULD WEAKEN THE BARREL STRUCTURE LEADING TO A RUPTURE. A RUPTURED BARREL CAN CAUSE SERIOUS INJURY AND/OR DEATH TO THE SHOOTER OR BYSTANDERS AND DAMAGE TO PROPERTY. DRILLING HOLES IN THE BARREL VOID ALL WARRANTIES.**

⚠ DANGER: SAFE FIREARMS HANDLING IS YOUR PERSONAL RESPONSIBILITY ALWAYS. Firearms have the potential to be dangerous resulting in serious injury or death if they are misused or handled inappropriately. Safety must always be the primary concern of anyone who owns or handles firearms. Accidents are the result of violating the rules of safe firearm handling. Professional firearm safety training is available to supplement the safety instruction in this manual. Some examples of organizations to contact are your local firearms dealer, state conservation department, hunter safety department, law enforcement agency, local sportsman's club, the National Shooting Sports Foundation (NSSF), and the National Rifle Association (NRA) for availability of firearms training.

⚠ DANGER: ALWAYS TREAT EVERY FIREARM AS IF IT IS LOADED AND WILL FIRE. Never assume or take anyone's word that the firearm is uncharged or unprimed. You must always physically check for yourself. Never pass a loaded firearm to another person. You must first open the action and then visually check that the firearm uncharged and unprimed before passing the firearm to another person. Keep your firearm uncharged, unprimed, not cocked, with no bullet in the barrel, and safely stored when not in use.

⚠ DANGER: NEVER PLACE YOUR FINGER INSIDE THE TRIGGER GUARD OR ON THE TRIGGER UNLESS YOU INTEND TO FIRE. Always keep your finger off the trigger until your sights are on the target and you are prepared to fire. Also make sure that other objects do not touch the trigger at any time.

⚠ DANGER: ALWAYS KEEP YOUR FIREARM POINTED IN A SAFE DIRECTION. Never point the muzzle of a firearm at anyone or anything you do not intend to shoot. Many incidents have occurred because people pointed what they thought was an unloaded firearm in an unsafe direction. This is especially important when loading, unloading, or field stripping the firearm. ALWAYS control the direction of the firearm.

⚠ DANGER: NEVER CROSS ANY OBSTACLES SUCH AS FENCES OR STREAMS WITH A CHARGED OR PRIMED MUZZLELOADING FIREARM. Always make sure your muzzleloading firearm is unprimed or unloaded before crossing a fence, climbing a tree, jumping a ditch, or negotiating any other obstacles.

⚠ DANGER: ALWAYS REMOVE THE PRIMER FROM THE BREECH PLUG BEFORE YOU CLIMB TO OR DESCEND FROM A TREE STAND. NEVER RAISE OR LOWER A PRIMED MUZZLELOADING FIREARM TO OR FROM A TREESTAND. Failure to follow this rule may cause serious injury and/or death to the shooter or bystanders and damage to property.

 **DANGER: NEVER LEAN A CHARGED AND PRIMED RIFLE AGAINST A TREE, A WALL, OR ANY SURFACE WHERE IT MAY FALL OVER.** Once a firearm has been charged or primed it is your responsibility to protect against any situation that may result in an accidental discharge. Failure to follow this rule may cause serious injury and/or death to the shooter or bystanders and damage to property.

 **DANGER: NEVER UNDER ANY CIRCUMSTANCES USE ALCOHOL OR DRUGS BEFORE OR WHILE SHOOTING.** In addition, do not use your firearm if you are on any medication which impairs, even slightly, your mental or physical. You should also not use your firearm if you are excessively tired, distracted, or impaired in any way. You need to be alert and have your full attention devoted to the safe use of the firearm.

 **DANGER: ALWAYS USE THE CORRECT COMBINATION OF MUZZLELOADING APPROVED LOAD COMPONENTS FOR YOUR PARTICULAR MUZZLELOADING FIREARM** as detailed in this manual.

 **DANGER: MAKE CERTAIN THE BARREL IS CLEAR OF ANY OBSTRUCTIONS BEFORE SHOOTING.** Dirt, water, snow and other objects may inadvertently become lodged in the bore of the barrel. A small obstruction can cause a dangerous increase in pressure and may damage your firearm and cause injury or death to you or bystanders. Refer to the cleaning section of this manual for instructions on how to remove any obstructions in the barrel.

 **CAUTION: BEFORE HANDLING ANY FIREARM, UNDERSTAND ITS OPERATION.** Not all firearms are the same and some have features and mechanical operation unique to that specific firearm. Before using a firearm you should learn the mechanical features of that specific firearm you intend to use. If you feel unsure about any operational aspects of this firearm, please contact Traditions® before proceeding with its operation.

 **WARNING:** This product can expose you to chemicals including lead, which is known to the State of California to cause cancer and birth defects or other reproductive harm. For more information go to www.P65Warnings.ca.gov.

APPROPRIATE USE FOR YOUR FIREARM MEANS USING YOUR FIREARM FOR LEGAL PURPOSES. It is your responsibility to ensure that you are in compliance with all applicable Federal, State, and Local laws and ordinances regarding the use of your firearm.

MAKE SURE THAT SLINGS, SCOPES, AND ANY OTHER ACCESSORIES ARE COMPATIBLE with the firearm and that they do not interfere with the safe operation of the firearm. It is your responsibility to understand and follow all instructions in this manual, as well as those which may be supplied with your ammunition and loading components and any accessory and how they all relate to each other.

 **DANGER: BEFORE YOU ACCEPT A FIREARM FROM SOMEONE, CONFIRM FOR YOURSELF THAT IT IS UNLOADED.**
Treat all firearms as if they are loaded and will fire.

 **DANGER: NEVER LEAVE A LOADED FIREARM UNATTENDED.**

 **CAUTION: DO NOT ATTEMPT TO SHOOT OR LOAD YOUR FIREARM UNTIL YOU HAVE READ THIS MANUAL COMPLETELY AND FULLY UNDERSTAND IT. FAILURE TO READ AND FOLLOW THESE INSTRUCTIONS COULD RESULT IN INJURY AND/OR DEATH TO THE SHOOTER OR BYSTANDERS AND DAMAGE TO PROPERTY. IF YOU ARE UNABLE TO UNDERSTAND ANY OR ALL OF THIS MANUAL, CALL THE CUSTOMER SERVICE DEPARTMENT AT TRADITIONS®.**

USE TRADITIONS® SCOPE MOUNTS ONLY. All current Traditions® rifles come drilled and tapped for use with scopes. Traditions® offers a wide variety of scopes, scope mounts, and rings in varying sizes and finishes to suit your needs. When mounting a scope use only Traditions® mounts to ensure proper fit and function. Traditions® mounts are specifically made to fit these predrilled existing holes in your firearm.

2. SAFE STORAGE & TRANSPORTATION

 WARNING: FIREARM SECURITY IS YOUR PERSONAL RESPONSIBILITY. ALWAYS SAFELY STORE AND SECURE YOUR FIREARM. You must ensure that your firearms are securely and safely stored so that children and/or unauthorized users may not obtain them. Your firearms should always be kept unloaded and locked when not in use or in your immediate control. Never assume that the use of a lock alone is sufficient to safely secure your firearm. You must continually evaluate your personal situation and employ security systems that prevent children and unauthorized users from gaining access to your firearm. It is recommended that you secure bullets, loading components, and primers in a locked container separate from your firearms.

 WARNING: DO NOT LOAD UNTIL READY TO DISCHARGE YOUR RIFLE.

 WARNING: FIREARMS ARE DANGEROUS IF THEY ARE USED AND/OR STORED IMPROPERLY. THEY POSE A RISK OF SERIOUS OR FATAL INJURIES. FIREARMS CAN BE ESPECIALLY DANGEROUS TO CHILDREN WHEN THEY ARE STORED IN AN IRRESPONSIBLE AND UNSAFE MANNER. FOR YOUR SAFETY AND THE SAFETY OF OTHERS, IT IS IMPERATIVE THAT YOU KEEP YOUR FIREARM LOCKED AND UNLOADED IN A SECURE PLACE. THE AMMUNITION AND LOADING COMPONENTS SHOULD BE STORED IN A SEPARATE, LOCKED, SECURE LOCATION WHEN NOT IN USE. SAFE AND SECURE STORAGE OF YOUR FIREARM IS ONE OF THE MOST IMPORTANT RULES OF FIREARM SAFETY. YOUR FAILURE TO FOLLOW THESE RULES MAY RESULT IN SERIOUS INJURY OR DEATH TO YOU OR OTHERS.

 WARNING: ALWAYS SECURE YOUR FIREARM IN A MANNER THAT WILL PREVENT UNAUTHORIZED ACCESS. Whenever you are not using your firearm it should be kept unloaded and locked. Your own safety and the safety of others demands that you always secure and store your firearm in a way that will prevent unauthorized access. Never leave a firearm unattended unless it is unloaded, locked, and secured.

 WARNING: MAKE SURE TO CHECK TWICE THAT YOUR FIREARM IS UNLOADED BEFORE TRYING TO INSTALL ANY LOCKING DEVICE.

 **WARNING: NEVER TRANSPORT A CHARGED OR PRIMED MUZZLELOADING FIREARM.** When transporting your firearm it must be uncharged, unprimed and securely locked. Safe and secure transportation of your firearm is another important aspect of your responsibility as a firearm owner.

 **DANGER: NEVER STORE A CHARGED OR PRIMED MUZZLELOADING FIREARM.** When storing your firearm it must be uncharged, unprimed and securely locked. If you fail to follow this instruction, you may experience a double load or fire the muzzleloader thinking it is unloaded.

 **WARNING: IF A PRIMER IS DROPPED IT MAY EXPLODE AND CAUSE INJURY AND/OR DEATH TO THE SHOOTER OR BYSTANDERS AND DAMAGE TO PROPERTY.**

 **CAUTION: ALWAYS STORE YOUR FIREARM AND AMMUNITION AND LOADING COMPONENTS SEPARATELY** so that they are not accessible to children or other unauthorized persons. Safe and secure storage of your firearm, ammunition, and loading components is your responsibility.

 **CAUTION: NEVER ASSUME THAT A "SECRET LOCATION" OR "HIDING PLACE" IS A SECURE STORAGE METHOD.** Without your knowledge others, such as children, may be aware of your storage location or they may find it by accident. It is your responsibility to properly store your firearms, ammunition, and loading components and to always make sure they are not accessible to children or unauthorized persons.

 **CAUTION: ALWAYS FOLLOW THE LAW!** In many states and local municipalities there are laws and regulations that make it a crime to keep a firearm unlocked in an area that is accessible to children or others. Keeping a firearm locked and unloaded when not in use is not only a common sense safety practice... IT IS THE LAW. You must be familiar with all local, state, and federal laws regarding the safe storage and transportation of your firearm. Failure to know and follow the law may result in unauthorized access or use of your firearm by another for which you may be held accountable. Obey all laws relating to the storage and transportation of firearms. Your local police department or gun shop can provide you with the pertinent information for where you live on storing and/or transporting a firearm safely and legally.

3. SAFETY RULES FOR YOUR TRADITIONS® MUZZLELOADER

In addition to the general Firearm Safety Responsibilities covered so far in this manual, there are additional guidelines specific to black powder muzzleloading firearms that must be adhered to at all times to ensure the safety of the shooter and others.

 **WARNING: UNDERSTAND THE TERMINOLOGY REGARDING LOADING.** When speaking of a Pursuit™ XT muzzleloading firearm “Charge” or “Charged” refers to the presence of a propellant powder charge and projectile in the bore of the firearm

“Uncharge” or “Uncharged” indicates that the powder charge and projectile have been either fired or removed and that the bore is completely clear.

“Prime” or “Primed” applies to the act of placing a primer or cap in or on the Pursuit™ XT.

“Unprime” or “Unprimed” indicates that the primer or cap has been removed from the firearm or is not in place.

 **DANGER: NEVER UNDER ANY CIRCUMSTANCE USE SMOKELESS POWDER OF ANY TYPE OR IN ANY QUANTITY IN A MUZZLELOADING FIREARM, AND NEVER MIX POWDERS.**

The use of any smokeless powder at all could result in a detonation or explosion which could cause injury and/or death to the shooter or bystanders and damage to property.

 **DANGER: NEVER USE ANY POWDER THAT YOU CANNOT POSITIVELY IDENTIFY.** The use of any mislabeled or unknown powder could result in injury and/or death to the shooter or bystanders and damage to property.

 **DANGER: USE ONLY BLACK POWDER OR AN APPROVED BLACK POWDER SUBSTITUTE IN YOUR TRADITIONS® MUZZLELOADING FIREARM.** Never use even small amounts of smokeless powder, even if it may be black in color. The use of any propellant other than black powder or approved black powder substitute may cause injury or death to the shooter or bystanders and damage to property.

 **DANGER: NEVER SMOKE OR ALLOW BYSTANDERS TO SMOKE WHILE USING YOUR MUZZLELOADER.** The spark from a lighted cigarette, cigar, or pipe can ignite Black Powder or a Black Powder substitute, Percussion Caps, or Primers. Smoking around a charged and/or primed muzzleloader, percussion caps, primers, or supply of powder may cause premature firing of the firearm or an explosion causing serious injury and/or death to the shooter or bystanders and damage to property.

 **DANGER: DO NOT LOAD A MUZZLELOADER WHICH IS HOT FROM PREVIOUS FIRING. ALWAYS ALLOW THE BARREL TO COOL BEFORE YOU BEGIN RELLOADING YOUR MUZZLELOADING FIREARM.**

 **DANGER: BEFORE YOU BEGIN LOADING, MAKE SURE YOUR MUZZLELOADING FIREARM IS NOT ALREADY CHARGED.** To make sure the firearm is uncharged, keep the muzzle pointed in a safe direction and insert the ramrod provided with the firearm into the bore. If the ramrod sits approximately $\frac{3}{4}$ " below the muzzle then the firearm is not charged, while if the end of the ramrod extends past the muzzle then it is charged and you will need to remove the charge.

 **DANGER: WHEN LOADING, MAKE SURE THAT THE PROJECTILE IS FIRMLY SEATED AGAINST THE POWDER CHARGE.** Serious personal injury or death can result if the projectile is not seated properly against the powder charge. A simple way to check this when loading is after you have fully seated a projectile against a powder charge mark the ramrod as a point of reference for a properly seated projectile.

 **DANGER: NEVER EXCEED THE RECOMMENDED MAXIMUM BLACK POWDER OR BLACK POWDER SUBSTITUTE CHARGE LISTED IN THIS BOOK.** If the recommended maximum charge is exceeded then injury or death to the shooter or bystanders can occur.

 **DANGER: NEVER POUND ON THE RAMROD WHEN LOADING.** Black powder and/or approved black powder substitutes are potentially sensitive to impact and could ignite from the impact of pounding on the ramrod. Always be sure to keep the muzzle pointed away from your face or body when loading. Place your fingers and hand around the ramrod, and not over the end of the ramrod when seating projectile for safety.

 **DANGER: NEVER PRIME YOUR MUZZLELOADING FIREARM UNTIL YOU ARE READY TO FIRE IT.** Your muzzleloader should remain unprimed until the instant before firing. After you prime the firearm, your full attention should be on the target and firing of the firearm.

⚠ DANGER: NEVER PASS A CHARGED MUZZLELOADING FIREARM TO ANOTHER PERSON. Once charged, a muzzleloading firearm requires your complete attention. Never charge the firearm and then hand it to another shooter. You should also never shoot a muzzleloading firearm that was charged by someone else. Only the person who actually performed the loading knows whether the firearm has been charged properly and should fire it.

⚠ DANGER: BEFORE YOU ACCEPT A MUZZLELOADING FIREARM FROM SOMEONE, CONFIRM FOR YOURSELF THAT IT IS UNPRIMED, UNCHARGED, AND CONTAINS NO BULLET. Treat all firearms as if they are loaded and will fire.

⚠ DANGER: NEVER CHARGE YOUR MUZZLELOADER DIRECTLY FROM A CAN, HORN OR FLASK. A spark from a previous firing may ignite the stream of powder being poured into the firearm and cause the container to explode. The explosion of a powder can, horn or flask may cause serious injury and/or death to the shooter or bystanders and damage to property. Use a separate pre-calibrated measuring device containing small quantities of powder to charge your firearm. Keep the muzzle directed away from your face and body when loading.

⚠ DANGER: WHILE SHOOTING ALWAYS KEEP SUPPLIES OF POWDER, PRIMERS AND CAPS WELL AWAY FROM YOUR FIRING POSITION OR SHOOTING BENCH. A powder horn, flask, can of powder, or quantity of primers or caps can ignite with deadly force if exposed to sparks or intense heat. Follow the manufacturer's instructions for safe handling and storage of powder, primers, or caps. Keep unused powder, primers, or caps well away from firearms that are being discharged. Sparks from the discharge of a muzzleloading firearm may cause the unused supply of powder, primers, or caps to ignite causing serious injury and/or death to the shooter or bystanders and damage to property.

⚠ CAUTION: BLACK POWDER AND BLACK POWDER SUBSTITUTES ARE CORROSIVE BY NATURE AND MAY LEAVE RESIDUES IN THE BORE AND ON THE FIREARM THAT REQUIRE IMMEDIATE CLEANING. A quick field cleaning should be performed just after you complete firing at the range or hunting. A thorough in depth cleaning is required before storage for any amount of time to keep the firearm functioning properly and in a safe condition. Failure to properly clean the firearm may prevent the firearm from functioning safely and correctly and may result in injury or death to the shooter or bystanders and damage to property.

You must follow these procedures every time a firearm leaves your hand, is cleaned, handed to you or another person, transported or stored.

4. LEARNING THE BASICS OF THE PURSUIT™ XT

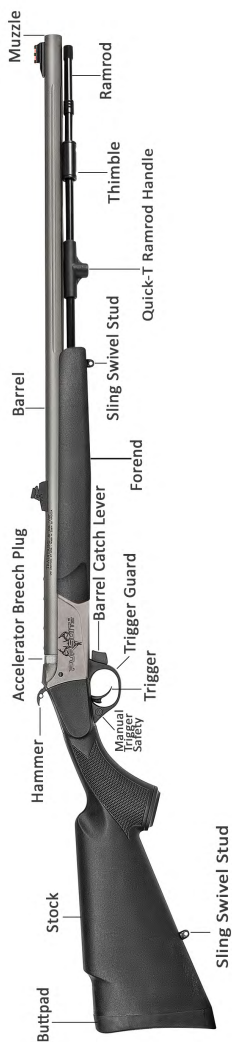

Please note your model may differ from the features you see here.

© 2021 Traditions® Performance Firearms. All Rights Reserved.

Model Designation On Frame



Serial Number Marking On Frame

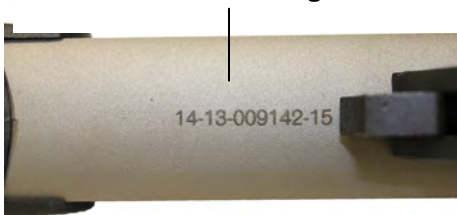

Propellant Marking On Barrel

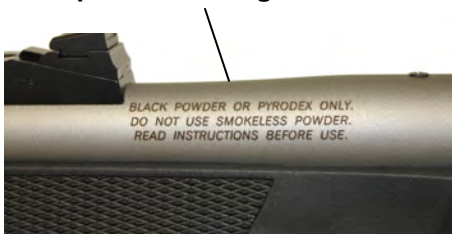

Caliber Designation On Barrel



PURSUIT™ XT

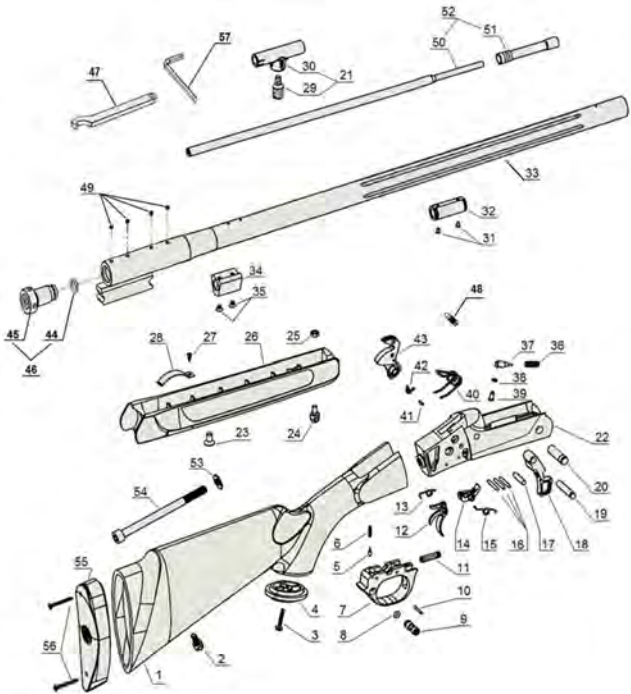

Number	Description	Reference	Number	Description	Reference
1	Stock (Synthetic)	FCS701070-2	30	Handle	560014
2	Sling Swivel Stud-Rear	37223	31	Ramrod Thimble Screw	400031
3	Pinof grip Cap Screw	50105	32	Ramrod Thimble	440032-P
4	Pinof Grip Cap	50104	33	Barrel Assembly (CeraKote-Stainless Steel)	FB741104
5	Ball	71000	34	Tenon	330023
6	Trigger Guard Spring	M71015	35	Tenon Screw (2 Units)	330022
7	Trigger Guard	M810027	36	Firing Pin Spring	M10011
8	O-Ring	71030	37	Firing Pin	71007
9	Safety	710032	38	Firing Pin Screw Washer	M71023
10	Safety Pin	M710029	39	Firing Pin Screw	730021
11	Barrel Catch Spring	M72017	40	Hammer Spring	M80017
12	Trigger	81003	41	Hammer Return Pin	M81013
13	Trigger Spring	M81016	42	Hammer Return Spring	M81014
14	Sear	81001	43	Hammer	83002
15	Sear Spring	M81015	44	Rubber O-Ring	70016
16	Trigger Guard and Trigger Pin (3 Units)	M710025	45	Speed Breach Plug	M7400099
17	Hammer Pin	M710026	46	Speed Breach Plug Assembly	7400099
18	Barrel Catch	71005	47	Speed Breach Plug Wrench	730029
19	Barrel Catch Pin	710023	48	Hammer Handle	710004
20	Frame Pivot Pin	300024	49	Plug Screw (4 Units)	26029
21	Handle Assembly	1595	50	Ramrod 26" (Aluminum)	110030
22	Frame (CeraKote-Stainless Steel)	84104	51	Ramrod Tip .50 Cal (Aluminum)	100028
23	Forend Stock Screw	10034	52	RamRod Assembly 26"	110011
24	Fore Stock Sling Swivel Stud	57022	53	Tang Screw Washer	M71019
25	Sling Swivel Stud Nut	60122	54	Tang Screw	M71016
26	Fore Stock (Synthetic)	FCS741070-1	55	Buttpad	74026
27	Ramrod Retaining Spring Screw	21817	56	Buttpad Mounting Screw (2 Units)	20634
28	Ramrod Retaining Spring	400030	57	Allen Wrench	M1005
29	Extension Handle Short	560028			

© 2021 Traditions® Performance Firearms. All Rights Reserved.



Quick-T™ Ramrod Handle Owner's Manual Addendum

Your muzzleloader includes the Quick-T™ Ramrod Handle which is designed to provide easy and quick loading of your Traditions® muzzleloader. This handle is designed to be stored on your ramrod for easy access. The Quick-T™ Ramrod Handle incorporates a palm saver and a jag to thread into the handle so it functions as a work/cleaning rod. **The Quick-T ramrod handle is NOT a ball starter.**

How to use your Quick-T ramrod handle:

- Your Quick-T™ Ramrod Handle will come installed on the ramrod of your new rifle. Simply remove your rifle's ramrod to remove the Quick-T™ Ramrod Handle.
- The Quick-T™ Ramrod Handle can be used in two ways.

1) When being used as a palm saver:

Using only the plastic "T" piece of the Quick-T™ Ramrod Handle, place the T-handle over the end of the threaded side of your ramrod. This is a quick and easy way to push your projectile down the barrel and protect your hand from the end of the ramrod.

2) When being used as a work/cleaning rod:

Screw the brass jag into the threaded pocket of your Quick-T™ Ramrod Handle. This allows the Quick-T™ Ramrod Handle to thread directly onto the 10/32 threads on your ramrod, providing a fully functional cleaning rod for maintaining your rifle in the field or at the range. If you over-tighten the jag into the Quick-T™ Ramrod handle, the hole in the screw-in brass jag will assist you in removal or tightening. Use a small Allen key through hole if needed.

CAUTION: Always follow the manufacturer's loading and shooting instructions. Be sure to read the owner's manual prior to using your rifle. Be sure the Quick-T™ Ramrod Handle does not extend past the end of the muzzle when firing your rifle. Never fire your rifle with the Quick-T™ Ramrod Handle threaded on your ramrod installed in the barrel thimbles. Never use the Quick-T™ Ramrod Handle as a ball starter.

5. SAFETIES INCLUDED ON THE PURSUIT™ XT

Your Traditions® Pursuit™ XT comes equipped with dual safeties. The first safety is an internal passive hammer block that prevents the hammer contacting the firing pin until the trigger is pulled.

Internal Rebounding Hammer Block Safety



When the hammer is in the **At Rest** position the internal hammer block safety is preventing the hammer from striking the firing pin unless the manual trigger safety is disengaged and the trigger is pulled. Note: There should be a small gap between the hammer and frame in this position.



When the hammer is in the **Full Cock** position - internal hammer block safety moves into a lower position.

The second safety is an ambidextrous mechanical manual trigger block safety that prevents the trigger from being pulled back and allowing the sear to become disengaged.



Manual Trigger Safety **disengaged or the "safety off."** If the red ring is visible, the firearm is no longer safe and is ready to fire.



Manual Trigger Safety is **engaged or the "safety on."** Firearm is in the safe position if no red ring is visible.

6. THE PURSUIT™ XT **ELITE XT™ SYSTEM**

The Pursuit™ XT is equipped with the Elite XT™ trigger and hammer system. This system has a precise and accurate trigger pull. It is designed with a rebounding hammer and a manual trigger safety. There are 2 positions the hammer can be in with the Elite XT™ system:

The At Rest Position

This position is where the hammer is sitting off of the firing pin and there is a slight gap between the hammer and the top of the frame. After the Pursuit™ XT is fired, the rebounding hammer should return to the At Rest position. Even in the At Rest Position, we recommend the manual trigger safety be engaged so the red ring is not visible until you are ready to cock the hammer on the Pursuit™ XT.



The Full Cock Position

In this position, the action will be locked and the Pursuit™ XT cannot be broken open. This should only be performed when ready to fire. The hammer should be pulled fully rearward and you should feel the hammer lock into place. The Pursuit™ XT is now in the ready-to-fire position and once the manual trigger safety is disengaged so the red ring is visible, the trigger can be pulled and the Pursuit™ XT will fire. See p. 31 for more information on firing the Pursuit™ XT.



7. INITIAL CLEANING OF THE PURSUIT™ XT

⚠ WARNING: Confirm that the firearm is unloaded before any cleaning and that the manual trigger safety is in the "safe" position.

CAUTION: When performing the initial cleaning be mindful to always point the barrel in a safe direction and not towards any hard surface. Treat every firearm as if it were loaded and can fire at any time.

NOTE: BEFORE YOUR INITIAL USE CLEAN AND LUBRICATE YOUR PURSUIT™ XT!

These are brief instructions on what to do before you use your Pursuit™ XT for the first time. Please review the disassembly instructions on page 38 for the complete set of cleaning instructions. When you remove your new Pursuit™ XT from the box there may be residues that need to be removed before shooting.

1. Unscrew and remove the Accelerator Breech Plug™ by using your fingers or the breech plug wrench supplied with the muzzleloader. Then close the action.
2. Remove the ramrod from the thimbles.
3. With the action closed, unscrew the forend screw using the supplied 4mm wrench and remove the forend from the barrel.
4. Open the action by pulling the barrel catch lever which will then allow the action to pivot open.
5. When the action starts to open lift the barrel up and out of the frame. Clean all items with hot, soapy water or muzzleloader bore solvent such as Traditions® EZ Clean™. This will remove any manufacturing residue that may be on the inside or outside of the barrel.
6. Dry all of the parts completely.



7. Apply a light coat of Traditions® EZ Clean solvent to a dry patch (or use Traditions® pre-saturated EZ Clean patches). Install a cleaning jag on your ramrod and place the patch over the jag. Run the patch up and down the bore.



8. Use the Traditions® Cleaning & Seasoning Patches to "season" the lands and grooves of the rifling before loading. This will allow for easier loading and cleaning throughout your shooting sessions.



9. Generously lubricate the threads of the breech plug with Traditions® breech plug grease. Be careful to not get any grease inside the breech plug.



10. Now reassemble your firearm.

A Note about maintenance procedures:

Proper maintenance and cleaning of your new muzzleloader will require you to remove the barrel from the frame. You must clean the muzzleloader each time it is used.

Please refer to the Cleaning & Maintenance section for more information. Take time before such cleaning to study the Disassembly/Assembly procedures and the accompanying photographs to thoroughly acquaint yourself with your muzzleloader's subassemblies.

8. BASIC EQUIPMENT FOR SHOOTING PURSUIT™ XT

 **CAUTION: DO NOT ATTEMPT TO FIRE OR LOAD YOUR MUZZLELOADING FIREARM UNTIL YOU HAVE READ THIS MANUAL COMPLETELY AND FULLY UNDERSTAND IT. FAILURE TO READ AND FOLLOW THESE INSTRUCTIONS COULD RESULT IN INJURY AND/OR DEATH TO THE SHOOTER OR BYSTANDERS AND DAMAGE TO PROPERTY. IF YOU ARE UNABLE TO UNDERSTAND ANY OR ALL OF THIS MANUAL, CALL THE CUSTOMER SERVICE DEPARTMENT AT TRADITIONS®.**

In order to shoot your Traditions® muzzleloader, you will need the following accessories or equipment listed below:

1. Proper eye protection specified for use with firearms.
2. Proper ear protection specified for use with firearms.
3. Black powder or an approved black powder substitute in the appropriate type for your firearm.
4. A powder measure - if using loose powder.
5. A powder flask - if using loose powder.
6. Projectiles appropriate for your firearm such as Traditions® Smackdown® bullets. **(Do not use projectiles not recommended by Traditions®)**
7. 209 Primers
8. .50 Caliber Dry Cleaning Patches.
9. A jag to hold cleaning patches.
10. An appropriate bore cleaning solvent for muzzleloaders (like EZ Clean™) or pre-saturated cleaning patches.

Note: While not required, a Traditions® range rod will make loading and cleaning easier and is recommended.

CAUTION: Be sure to read any addendums which have been included with this manual and understand what ignition system your muzzleloader has. Some models such as the Northwest Magnum series may use musket caps instead of 209 primers. If you are unsure what type of ignition system is on your muzzleloader, please contact Traditions® customer service department.

9. PREPARING TO CHARGE YOUR PURSUIT™ XT

⚠ DANGER: ALWAYS POINT THE MUZZLE IN A SAFE DIRECTION AND DO NOT HAVE ANY PART OF YOUR BODY OVER THE MUZZLE WHEN LOADING.

⚠ DANGER: BEFORE YOU BEGIN LOADING, MAKE SURE YOUR PURSUIT™ XT IS UNCHARGED AND UNPRIMED. To make sure the firearm is uncharged, keep the muzzle pointed in a safe direction and insert the ramrod provided with the firearm into the bore. If the ramrod sits approximately $\frac{3}{4}$ " below the muzzle then the firearm is not charged, while if the end of the ramrod extends past the muzzle then it is charged and you will need to remove the charge.

PREPARING TO LOAD THE CHARGE:

⚠ WARNING: WEAR PROPER EYE PROTECTION FOR THE ENTIRE LOADING PROCESS.

Prior to loading, you must first ensure that the firearm is uncharged, unprimed, and the barrel is free of any obstructions.

The easiest way to achieve this is to remove the Accelerator Breech Plug™ and look down the barrel to see if there is a charge or any obstruction in the barrel.

You may also use the following instructions to ensure the firearm is uncharged and unprimed.

1. Push the safety button to "safe" so that no red ring is visible on the safety button.
2. Remove the ramrod from the thimbles.
3. Unscrew the jag from the ramrod and reverse the jag 180 degrees so that the concave (hollowed end) is exposed.
4. Re-thread the jag so that the concave (hollowed end) is out. This will make the ramrod longer and provide the proper length.



© 2021 Traditions® Performance Firearms. All Rights Reserved.

5. Insert the ramrod into the barrel. When it is touching the top of the breech plug it should sit approximately 3/4" below the muzzle.

Note: You should hear a metallic sound as the jag makes contact with the breech plug.

If the ramrod is not 3/4" below the muzzle and you do not hear the metallic sound then the barrel may be either obstructed or loaded. To remove the obstruction, remove the Accelerator Breech Plug™. Do not attempt to clear the barrel by firing. Before loading anything into the barrel, clean all oil and grease from inside the barrel. We recommend using Traditions® cleaning products to enhance your accuracy and ease shooting & cleaning.

Prior to loading, we suggest testing and clearing the ignition channel. Please follow these steps:

 **DANGER: CONFIRM THAT THE PURSUIT™ XT IS UNCHARGED AND THERE ARE NO OBSTRUCTIONS IN THE BARREL.**

Point the rifle down towards a safe area on the ground and load a primer into the 209 primer pocket of the breech plug. Fire one or two primers to blow out any oil or residue from the fire channel. Point the muzzle at a leaf or blade of grass to see if it moves. If it moves, you have a clear channel. If not, fire additional primers or check the breech plug for obstructions.

Another way to see if you have a clear fire channel is to screw a loading/cleaning jag on your ramrod and place a dry patch on the muzzle of your rifle. Push the patch down to the breech plug face and leave ramrod & patch in bore. Point rifle in a safe direction, place primer in the breech plug and fire two primers. Remove ramrod from the bore and inspect patch. Patch should have a complete circular burn in middle. This tells you that you have a clear fire channel. Stand the butt of the rifle on the ground so that the muzzle is pointed up and away from you and others. Never work with your face or any part of your body over the muzzle, even when the muzzleloader is unloaded. Be sure that the firearm is unprimed and the safeties are engaged. Your rifle is now ready to be loaded.

10. CHARGING THE PURSUIT™ XT

⚠ DANGER: ALWAYS POINT THE MUZZLE IN A SAFE DIRECTION AND DO NOT HAVE ANY PART OF YOUR BODY OVER THE MUZZLE WHEN LOADING.

⚠ DANGER: BEFORE YOU BEGIN LOADING, MAKE SURE YOUR PURSUIT™ XT IS UNCHARGED AND UNPRIMED. To make sure the firearm is uncharged, keep the muzzle pointed in a safe direction and insert the ramrod provided with the firearm into the bore. If the ramrod sits approximately $\frac{3}{4}$ " below the muzzle then the firearm is not charged, while if the end of the ramrod extends past the muzzle then it is charged and you will need to remove the charge.

LOADING THE CHARGE

Use only black powder or an approved black powder substitute. Follow the powder manufacturer's instructions when measuring any type of powder as not all powders are measured the same. Some are measured by weight and some by volume, and volumetric measuring can vary depending on the type and manufacturer of the powder. (See p. 45 for more information on black powder and black powder substitutes)

When loading loose powder:

1. Fill your Traditions® flask with Black Powder or Black Powder substitute of your choice.



2. Adjust your Traditions® powder measure to the desired correct charge for the type of powder you are using based on the powder manufacturer's recommendations.



3. Pour powder from your Traditions® flask into the powder measure. Pour powder from the powder measure down the barrel.

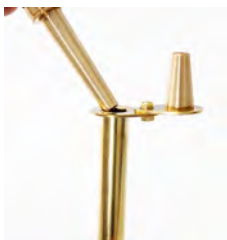

⚠ DANGER: NEVER LOAD POWDER INTO YOUR MUZZLELOADER DIRECTLY FROM A CAN, POWDER HORN, OR FLASK. ALWAYS USE A SEPARATE CALIBRATED POWDER MEASURING DEVICE. A REMAINING SPARK OR EMBER IN THE BARREL MAY CAUSE SERIOUS INJURY AND/OR DEATH TO YOU OR BYSTANDERS AND DAMAGE TO PROPERTY.

4. Tap the side of the barrel to help settle the powder into the breech area.

When Loading Pelletized Powder (Pellets):

Drop the desired amount of pellets into the barrel with the igniter side down. Using a pipe cleaner to handle the pellets makes it easier to load and keeps oil from your hands off the pellet.



⚠ WARNING: ALWAYS FOLLOW THE RECOMMENDED LOAD INFORMATION PROVIDED BY THE POWDER MANUFACTURER. FAILURE TO DO SO COULD CAUSE INJURY AND/OR DEATH TO THE SHOOTER AND BYSTANDERS AND DAMAGE TO PROPERTY.

LOADING THE PROJECTILE:

⚠ WARNING: DO NOT LOAD OR FIRE ANY PROJECTILES THAT ARE NOT APPROVED BY TRADITIONS FIREARMS DUE TO EXCESSIVE PRESSURES. INJURY AND/OR DEATH TO THE SHOOTER OR BYSTANDERS AND DAMAGE TO PROPERTY MAY OCCUR. VISIT WWW.TRADITIONSFIREARMS.COM.

⚠ WARNING: DO NOT USE PATCHED ROUND BALLS, CONICALS, OR MINIE BALLS.

⚠ WARNING: BE SURE ONLY ONE PROJECTILE IS LOADED IN THE BARREL. DO NOT LOAD A PROJECTILE ON TOP OF ANOTHER. INJURY AND/OR DEATH TO THE SHOOTER OR BYSTANDERS AND DAMAGE TO PROPERTY MAY OCCUR.

⚠ WARNING: NEVER LOAD A BULLET FROM THE BREECH. INJURY AND/OR DEATH TO THE SHOOTER OR BYSTANDERS AND DAMAGE TO PROPERTY MAY OCCUR.

TRADITIONS® SMACKDOWN® SABOTED BULLETS:

The plastic material used in Traditions® sabots is self-lubricating. Therefore you do not need to pre-lube your bullets or sabots. NOTE: Always follow the bullet manufacturer's loading instructions.

1. Insert the base of the bullet into the sabot, making certain the bullet is firmly and fully seated against the bottom of the sabot.
2. Place the assembled projectile into the muzzle.
3. Start the projectile with your thumb.
4. Using a ball starter, place the shaft on top of the bullet and push it downward until the starter hits the top of the muzzle.



5. With the concave end of the loading jag on your ramrod, position the ramrod on top of the bullet inside the bore. Holding the ramrod no further than 6" over the bore, apply firm pressure downward until the bullet is seated against the powder charge. (Holding the ramrod higher will increase your chances of breaking your ramrod.)

⚠ WARNING: WE RECOMMEND THAT ANY TIME YOU CHANGE TO A DIFFERENT PROJECTILE IN THE PURSUIT™ XT THAT YOU FOLLOW THIS PROCEDURE. WE RECOMMEND THE USE OF A NEW RAMROD WITH A MARK SOLELY FOR THAT SPECIFIC BULLET.

6. To avoid the dangers of loading more than one bullet, the first time you load your Pursuit™ XT you must insert the ramrod and mark the bullet seated location.
7. Make sure to remove the ramrod from the barrel before firing the Pursuit™ XT.



Note: If you are using pelletized powder do not crush them when loading the bullet. Testing has shown that crushed or broken pellets will cause accuracy issues.

⚠ DANGER: NEVER PLACE YOUR HAND OVER THE RAMROD AFTER INTRODUCTION OF THE BULLET INTO THE BARREL. WHILE UNLIKELY, A DISCHARGE ON LOADING COULD EXPEL THE RAMROD AND CAUSE INJURY AND/OR DEATH.

IMPORTANT: ALWAYS SEAT THE BULLET FIRMLY ON TOP OF THE POWDER CHARGE. FAILURE TO DO SO MAY RESULT IN INJURY AND/OR DEATH TO THE SHOOTER OR BYSTANDERS AND DAMAGE TO PROPERTY MAY OCCUR.

MARKING THE RAMROD TO SHOW WHEN THE PURSUIT™ XT HAS A PROPERLY SEATED BULLET WILL ALLOW THE USER TO KNOW IF THE PURSUIT™ XT HAS BEEN DOUBLE LOADED OR IF THE BULLET IS NOT SEATED ALL THE WAY AGAINST THE POWDER CHARGE.

11. PRIMING THE TRADITIONS® PURSUIT™ XT

⚠ DANGER: ALWAYS POINT THE MUZZLE IN A SAFE DIRECTION AND DO NOT HAVE ANY PART OF YOUR BODY OVER THE MUZZLE WHEN LOADING.

⚠ WARNING: FOLLOW MANUFACTURER'S WARNINGS & RECOMMENDATIONS WHEN INSTALLING THE PRIMER.

⚠ WARNING: DO NOT PRIME YOUR PURSUIT™ XT UNTIL IMMEDIATELY BEFORE YOU ARE PREPARED TO FIRE.

⚠ WARNING: WEAR PROPER EYE PROTECTION WHEN LOADING.

When priming your muzzleloader please follow these instructions. Only prime your muzzleloader after you have loaded the rifle and you are ready to shoot. Please sure of what type of primer your muzzleloader may take. While most models take a 209 primer, Traditions® does carry models, like the Northwest Magnum series, which take a musket cap. If you are unsure of which primer your muzzleloader takes please contact Traditions® customer service department. The following instructions reference the 209 primer but the process would be the same when using a musket cap.

1. Make sure that the manual safety on your muzzleloader is in the "safe" position.
2. Point the muzzleloader in a safe direction.
3. Keeping the muzzle pointed in a safe direction, open the action to expose the breech area. Using a 209 capper or your fingers, press the primer into the opening in the breech plug. Be sure the primer is fully seated into the breech plug. Close the action of the muzzleloader.



4. Your muzzleloader is now ready to fire.

12. FIRING THE TRADITIONS®

PURSUIT™ XT

 **DANGER: ALWAYS POINT THE MUZZLE IN A SAFE DIRECTION AND BE SURE OF YOUR TARGET AND WHAT IS BEYOND IT.**

 **WARNING: BE SURE TO WEAR PROPER EYE AND EAR PROTECTION ANY TIME YOU FIRE YOUR PURSUIT™ XT. MAKE SURE ALL BYSTANDERS IN THE AREA ARE ALSO WEARING PROPER EYE AND EAR PROTECTION AT ALL TIMES.**

 **WARNING: NEVER SOLELY RELY ON THE MECHANICAL SAFETY OF YOUR PURSUIT™ XT FOR YOUR SAFETY AND THE SAFETY OF OTHERS. IT SHOULD NOT REPLACE PROPER FIREARM HANDLING PROCEDURES DESCRIBED IN THIS MANUAL.** Mechanical features such as safeties can fail and should never be relied upon with disregard to proper safe firearms handling. You should always maintain proper safety practices as outlined in this manual.

 **WARNING: NEVER FIRE THE PURSUIT™ XT WITH ONLY LOOSE POWDER OR PELLETS AND NO PROJECTILE. THIS COULD RESULT IN PARTICLES EXITING THE BARREL.**

Now after following the previous loading instructions, your Pursuit™ XT is charged, primed, and ready to fire.

1. Grasp the Pursuit™ XT firmly with both hands with your finger off the trigger and out of the trigger guard. Make sure the safety is on and the red ring is not visible. Raise the Pursuit™ XT up and firmly pull the stock into your shoulder.
2. Pull the hammer back slowly until it is in the full cock position. Your safety should remain in the "safe" position so the red ring is not visible. The Pursuit™ XT is now cocked and ready to fire. **Never carry the Pursuit™ XT in the cocked position. Do not disengage safety until you are ready to fire. If you decide not to fire, see page 34.**
3. Acquire your target and aim with your sights or scope. Remember to be sure of what is beyond your target.

 **WARNING: DO NOT COCK THE PURSUIT™ XT UNTIL YOU ARE READY TO FIRE.**

4. Disengage the manual trigger safety so the red ring is visible. Slowly squeeze the trigger until the Pursuit™ XT fires. Once the Pursuit™ XT fires place the trigger safety back on safe by pushing it from left to right so no red ring is visible.

13. DEPRIMING YOUR MUZZLELOADER AFTER FIRING:

1. Press the barrel catch lever and open the action to expose primer.
2. Using either a de-priming tool or finger, remove the spent primer.

14. MISFIRES & HANGFIRES

If, after following the previous instructions, the Pursuit™ XT did not fire then you have had a Misfire or Hangfire. Anyone involved with firearms may experience a misfire or hangfire at one time or another. The following are a few simple procedures that will help you to effectively manage such occurrences..

 WARNING: A MISFIRE OR HANGFIRE IS A DANGEROUS SITUATION AND IT IS IMPERATIVE YOU PROCEED WITH EXTREME CAUTION. AS YOU ALWAYS SHOULD DO, BUT ESPECIALLY IN THIS SITUATION, BE SURE TO KEEP THE PURSUIT™ XT POINTED IN A SAFE DIRECTION AS IT MAY FIRE AT ANY TIME.

A **MISFIRE** is a failure of either the primer or the main charge to ignite. This could be a very hazardous situation.

 WARNING: Extreme caution should be exercised when dealing with a misfire or hangfire.

Rarely is a misfire the fault of the firearm. Generally, it can be attributed to a problem with the propellant or primer. Should your Pursuit™ XT fail to fire for any reason, **keep the Pursuit™ XT pointed at your down-range target for at least one minute with the action closed. By doing so, you make sure you are prepared for the chance of a delayed ignition.**

If the primer did not fire:

1. Check to make certain that a primer was installed and is still securely positioned in primer pocket of the breech plug.
2. Verify that the action is free of debris.
3. Try a new primer.

If the primer fires but the main charge does not:

1. Keep the muzzle pointed at your down-range target for at least one minute with the action closed. Press the safety button to engage the trigger block safety. After waiting one minute, then remove the primer while still keeping the barrel pointed in a safe direction. Using a cleaning pick, verify that the communication hole in the breech plug is clear of any obstruction.
2. Tap the butt pad of the rifle with your hand to direct the powder into the ignition channel. If you are using pellets this process will not be helpful.
3. Verify that propellant was loaded under your projectile by running the ramrod down the muzzle and observing the measure marks on your ramrod. Use extreme caution to always keep the muzzle pointed in a safe direction.
4. Check for any mechanical defects in the breech area. If your muzzleloader has repeatedly failed to fire, you will need to unload the rifle. At this point a beginning shooter should seek assistance from an experienced shooter. Never leave an unfired charge in the barrel.
5. After verifying the above directions reprime the muzzleloader and fire.

Hangfire

A hangfire is a delayed ignition. The primer fires when the trigger is pulled and the main charge fires a brief moment later. There are many reasons that hangfires occur. If you are experiencing hangfires, there are possible causes that you need to evaluate. Verify the following:

1. Verify that the primer is the correct size and properly fitted into the primer pocket.
2. Inspect that the ignition channel is clear of obstructions.
3. Verify that the proper propellant is being used and that it is the proper granulation and is free from moisture, contamination and oils.
4. Check the condition of the primers and propellant powder. For hunting situations, it is a wise practice to use fresh primers and powder. Use a fresh load for each day's hunting.

If you experience a **MISFIRE** or **HANGFIRE** keep the Pursuit™ XT pointed down range for one minute. The Pursuit™ XT could fire so be prepared for this. If the firearm does not fire after one minute, keep the Pursuit™ XT pointed downrange and carefully unload your firearm, making sure not to expose yourself to the breech area. Dispose of defective primers and powder in accordance with your local, state, and federal laws and regulations.

15. DE-COCKING THE PURSUIT™ XT

⚠ WARNING: ALWAYS KEEP THE MUZZLE POINTED IN A SAFE DIRECTION AND BE SURE OF YOUR TARGET AND WHAT IS BEYOND IT.

NOTE: When the Pursuit™ XT is in the full cock position, the action is locked in battery and cannot be opened.

If your Pursuit™ XT is in the full cock position and you no longer want to fire the muzzleloader, carefully follow these steps to de-cock the firearm.

Unloading can be accomplished into the At Rest position. Once the hammer is in this position, engage the manual trigger safety.

Follow the directions below:

1. Both hands should be dry and not impeded in any way.

2. Disengage the manual trigger safety by pressing the button from right to left so the red ring is visible.

⚠ WARNING: THE FIREARM IS NO LONGER IN THE "SAFE" POSITION.

3. Carefully, while holding your thumb on the hammer in the cocked position, depress the trigger slowly until you feel the hammer release. Immediately release your finger from the trigger and slowly lower the hammer in a controlled manner into the At Rest position. Engage the manual trigger safety so the red ring is no longer visible. At this point you can safely open the action.



NOTE: Practice this with an unloaded firearm so you feel comfortable with the process of safely lowering the hammer.

⚠ WARNING: NEVER DRY FIRE YOUR PURSUIT™ XT

16. UNLOADING THE PURSUIT™ XT

 **DANGER: ALWAYS POINT THE MUZZLE IN A SAFE DIRECTION AND DO NOT HAVE ANY PART OF YOUR BODY OVER THE MUZZLE WHEN UNLOADING.**

There are two different methods for removing the projectile and charge:

Method 1

Note: It is recommended to use either a Traditions® range rod or ramrod extension for this method.

1. Make sure the muzzle of the barrel is pointed in a safe direction at all times.
2. Open the action and carefully remove the primer from the breech plug
3. Using your fingers, rotate the Accelerator Breech Plug™ counterclockwise. Depending on the amount of shooting done you may have to use your spanner wrench to loosen the breech plug.
4. Insert a ramrod or range rod into the muzzle and push the load out the breech end of the barrel.
5. Clean and wipe all surfaces to remove loose fouling and debris.

Method 2

1. Open the firearm and carefully remove the primer from the breech plug.
2. Using a range/bench ramrod, with a ball puller screw in one end, insert the screw end into the muzzle until the screw makes contact with the projectile.
3. Apply pressure to the end of the ramrod while at the same time turning it, allowing the ball puller screw to bite into the projectile.
4. Continue turning the ramrod until you can determine that the ball puller screw is well anchored into the projectile.
5. Firmly grasp the exposed end of the ramrod with projectile attached, pull it through the barrel and out of the muzzle. One continuous non-stop pull is generally best.

Note: When extracting sabot bullets the first few inches of the pull will separate the projectile from the plastic sabot. At this point the bullet will be free from the sabot and will come out easily. It will then be necessary to reinsert the ball puller screw back down the barrel and screw it into the plastic sabot and also pull it out.

 **CAUTION: DISCARD ANY BULLET REMOVED FROM THE BARREL. THE BULLET MAY HAVE BECOME DEFORMED OR THE SABOT MAY BECOME COMPROMISED WHEN UNLOADING.**

6. Remove powder, if any.
7. Clean and dry the bore of the barrel making sure the breech area is dry before reloading fresh powder.

17. CLEANING & MAINTENANCE

 WARNING: ALWAYS POINT THE PURSUIT™ XT IN A SAFE DIRECTION AND TREAT THE PURSUIT™ XT AS IF IT WAS LOADED AND CAN FIRE.

 WARNING: CONFIRM THE PURSUIT™ XT IS UNLOADED BEFORE CONDUCTING ANY OF THE METHODS IN THIS SECTION.

 WARNING: DO NOT DISASSEMBLE YOUR PURSUIT™ XT ANY FURTHER THAN WHAT IS DESCRIBED IN THIS MANUAL.

Disassembling your Pursuit™ XT further could cause the firearm to become unsafe. As a result, it could cause serious injury and/or death to the shooter or bystanders and could damage the Pursuit™ XT.

 WARNING: CONFIRM NO POWDER CHARGES, PRIMERS, OR PROJECTILES ARE PRESENT OR AVAILABLE DURING ANY DISASSEMBLY, CLEANING, OR REASSEMBLY.

NOTE: Reference to the exploded view diagram in the manual will help identify part names and numbers.

RANGE/FIELD CLEANING AND ADVICE **WHILE SHOOTING**

A systematic routine of cleaning while shooting is strongly advised to aid in avoiding problems while loading and to optimize accuracy. When target shooting or sighting in, develop a habit of consistently cleaning your barrel after each shot. Depending upon the specific load, temperature, and humidity, a short series of shots with black powder or black powder substitute can be fired before it becomes necessary to clean your barrel and remove fouling build-up.

Suggested Method

Make sure the Pursuit™ XT is uncharged and unloaded. The safety should be in the "safe" position so no red ring is visible and should always be pointed in a safe direction. With the action open, take a Traditions® dry patch and saturate it in bore solvent (or you can use a pre-saturated cleaning patch.) Traditions® suggests using a Traditions® Range Rod but you can also use the ramrod that comes with the Pursuit™ XT with the jag flipped around to elongate the rod. Place the patch over the end of your rod and insert it into the muzzle end of the Pursuit XT™. Run the patch up and down to remove any fouling. Remove the saturated patch and discard. Place a dry patch over the end of the rod and run the dry patch from the muzzle to the breech to remove any moisture. Do this until the patch is clean. Repeat this process as many times as necessary until your barrel is clean. The same process should be repeated going from the breech. Repeat as necessary to remove fouling.

NOTE: A dirty fouled barrel will directly affect your ability to group shots. However, in a hunting situation, only a few shots will likely be taken. If the barrel is prepped and lubed at the onset, it is not necessary to clean and lube the interior of the barrel between shots when hunting.

ADDITIONAL RANGE CLEANING ADVICE

NOTE: It should never be necessary to hammer or excessively force a projectile down the bore. Projectiles should load firmly with pressure from the ramrod down the barrel. If the projectile is the proper size, unusual resistance usually indicates a need to clean the bore.

1. Do not use shooting patches when cleaning your Pursuit™ XT. They are too small. You should use Traditions® cleaning patches.
2. If a patch gets stuck, use Traditions Patch Puller Worm attached to a ramrod for retrieval, or if necessary, remove the breech plug and push the patch out through the breech area. Never load a charge over a lost patch.
3. If unusual resistance is felt while loading your projectile, perform the suggested cleaning method to remove as much of the fouling build up as possible.
4. If for any reason the projectile will not go all the way down to the powder charge, it will be necessary to extract the projectile from the barrel either with a bullet puller on a ramrod or the breech plug can be removed, the charge removed and the projectile forced out the end of the barrel with a long bench/range rod or an extended ramrod.

NOTE: It should never be necessary to hammer or excessively force a projectile down the bore. Projectiles should load firmly against the powder charge with a series of short strokes. If the projectile is the proper size, unusual resistance usually indicates the need to swab the bore with a treated cleaning patch. Use cleaning solvent if barrel is heavily fouled. An occasional cleaning of the bore with a brass Traditions® Bore Brush is advisable to remove excessive plastic and fouling build-up.

18. DISASSEMBLY, DETAILED CLEANING, & REASSEMBLY

 **WARNING: ALWAYS POINT THE PURSUIT™ XT IN A SAFE DIRECTION AND TREAT THE PURSUIT™ XT AS IF IT WAS LOADED AND CAN FIRE.**

 **WARNING: CONFIRM THE PURSUIT™ XT IS UNCHARGED AND UNPRIMED BEFORE CONDUCTING ANY OF THE METHODS IN THIS SECTION.**

 **WARNING: DO NOT DISASSEMBLE YOUR PURSUIT™ XT ANY FURTHER THAN WHAT IS DESCRIBED IN THIS MANUAL.**

Disassembling your Pursuit™ XT further could cause the firearm to become unsafe. As a result, it could cause serious injury and/or death to the shooter or bystanders and could damage the Pursuit™ XT.

Required Tools & Supplies

- Dry Patches
- 4mm Allen Wrench
- Traditions® Range Rod or Ramrod with Jag
- Pipe Cleaners
- Safety Glasses
- Cleaning Jag
- Traditions Parts Bath
- Breech Plug Grease
- Cleaning Solvent
- Seasoning Patches
- Bronze Brush
- Nylon Brush
- Breech Plug Wrench

The disassembly procedure is most often used for general cleaning, lubrication, and inspection of your Traditions® Pursuit™ XT. Traditions® recommends this be completed after each shooting session. By following this procedure it will help keep your Pursuit™ XT shooting safely and reliably for years to come.

DISASSEMBLY

1. **Follow all safety rules listed previously in this manual. Be sure the safety is engaged so it is in the "safe" position and the red ring is not visible.**
2. To check if the muzzleloader is unloaded, remove the ramrod and unscrew the jag. Re-attach at the opposite end of the jag. Place the ramrod down the barrel. The fully extended ramrod should sit 3/4" below the muzzle on an unloaded rifle. If your ramrod extends beyond the muzzle, you will need to disassemble the muzzleloader and remove the obstructions before proceeding.

3. Open rifle by depressing the barrel catch lever and remove Accelerator Breech Plug. NOTE: Remove the barrel from the frame. Pour some hot water into the barrel and let it soak for about a 1/2 hour. Secure the barrel in a padded vise. Position the wrench onto the breech plug and remove. Be careful not to scald yourself with the hot water. If you don't have access to hot water, as an alternative you could spray penetrating oil down the muzzle and let it sit for 1 hour and then continue by putting it in the vise.
4. Inspect the barrel to be sure your rifle is unprimed, unloaded, and free of obstruction.
5. Remove the forend stock screw from the barrel assembly using the 4mm Allen wrench.
6. Remove the barrel from the frame by pushing the barrel catch lever in.
7. When the barrel starts to open, lift the barrel out of the frame. You can now clean your barrel and frame. Field disassembly is now complete.



DETAILED CLEANING

⚠ WARNING: WEAR SAFETY GLASSES WHILE CLEANING TO PROTECT EYES FROM FLYING SPRINGS OR SOLVENTS.

The Traditions® Pursuit™ XT is designed to reduce internal fouling of the frame and its' components. Detailed cleaning, lubrication, and inspection of the entire Pursuit™ XT system should be performed after you are done shooting for the day and before storing for an extended period of time. Performing this detailed cleaning will help keep your Pursuit™ XT in its' best operating condition.

After following the disassembly instructions, your Pursuit™ XT should be disassembled.

Follow all safety rules listed previously in this manual. Be sure the safety is engaged so it is in the "safe" position and the red ring is not visible.

1. Using Traditions® Range Rod or your ramrod, attach the Bronze Brush to your ramrod.

Note: We recommend the Bronze Brush because it is excellent at hard scrubbing and removing fouling.

2. Spray a bore solvent, such as Traditions® EZ Clean 2 or BlackOut 209 solvent, on your bronze brush. Note: Traditions® Foaming Bore Solvent can also be used instead of spraying the bore solvent on the bronze brush. Allow solvent to sit for 15 minutes inside the barrel. This will allow time for the solvent to engage and penetrate the fouling. Do not let it dry.

3. To clean your breech plug, spray the breech plug inside and out with solvent or drop the breech plug into the EZ Clean™ parts bath system to loosen the residue and fouling on the plug. Let the solvent sit or if using the parts bath method, let the breech plug sit in the solvent for 10 minutes. Use a stiff brush to clean the outside threads and inner area of the breech plug including the fire channel. A pipe cleaner can be used to get the smaller areas clean and dry. Wipe with a clean cotton cloth. Repeat until all residues are off.

4. To clean your barrel, insert your bronze brush into the breech area. Push the ramrod from the breech to the muzzle until the brush exits the muzzle. Pull the ramrod back through the barrel towards the breech. The technique allows you to help break up fouling.



5. Remove the bronze brush from the ramrod and attach the cleaning jag.

6. Place a dry cotton patch over the jag and insert it into the breech. Run the ramrod with the patch from the breech to the muzzle. Pull the ramrod back through to the muzzle. Repeat until patch comes out clean.



7. Using a Traditions® Cleaning & Seasoning Patch or some gun lube on a dry patch, place the patch over the cleaning jag and insert into the muzzle. Push the patch from the muzzle to the breech. This will help protect against rust and allow for easier loading.



8. Lightly spray the barrel lug with Traditions® Cleaning Solvent. Wipe the solvent off with a dry cotton cleaning patch. If these areas are heavily fouled use the nylon brush to help remove fouling from the barrel catch and pivot points.



9. Apply a light coating of gun oil to the outside of the barrel and all metal surfaces including the extractor.



10. To clean the inside of the frame, lightly spray cleaning solvent on the inside of the frame. Use the Nylon Brush or a dry patch to remove fouling. Be sure the fouling is removed from the frame face and the barrel catch. Use a dry patch to remove any residual moisture.



11. Pull the trigger and push the hammer forward so the firing pin is exposed. Use a dry patch that has been sprayed with solvent to clean the exposed portion of the firing pin. After the firing pin has been cleaned, release the trigger and remove your thumb from the hammer. The hammer should move into the At Rest position and the firing pin should recess back into the frame.



12. To clean the outside of the frame, lightly spray it with solvent. Use the Nylon Brush to remove any fouling from the outside of the frame, the barrel release lever, hammer, hammer extension, and inside the hammer channel.



13. Oil the inside and outside of the frame. Be sure to oil all metal surfaces.



14. Lightly grease the pivot points on the frame.

15. Generously lubricate the threads of the breech plug with breech plug grease. Not using the recommended lubricant will cause o-ring damage and breech plug seizure.

You have completed the detailed cleaning of your Pursuit™ XT. You can now reassemble your firearm.

REASSEMBLY

1. Press the barrel catch lever in and reinstall the barrel assembly onto the frame and lock into place.



2. Reinstall the forend onto the barreled action.



3. Install the forend screw back into the forend using the 4mm Allen wrench.

⚠ WARNING: DO NOT OVERTIGHTEN. THIS COULD CAUSE DAMAGE TO YOUR PURSUIT™ XT.



4. Reinstall the Accelerator™ Breech Plug. Note: Before attempting to install the Accelerator Breech Plug™ be sure to inspect the fire channel of the breech plug to make sure it is clean and free of any obstructions.

Place the lubricated breech plug in the barrel and thread the breech plug into the barrel using your fingers and rotating the breech plug in a clockwise rotation. Continue to do so until the Accelerator Breech Plug™ makes contact with the barrel and seats firmly.

CAUTION: If the breech plug does not thread smoothly or seat fully, remove it and visually inspect the o-ring for wear and the threads on the plug and inside the barrel for fouling or obstructions. With proper maintenance and care the o-ring will last many years. The o-ring is in place as a gas check and helps to block fouling from reaching the threads. The plug can still be used without the o-ring but may become difficult to remove due to the fouling that will take place.

5. Reinstall your ramrod through the thimbles.

Reassembly of the Pursuit™ XT is now complete.

 **WARNING: DO NOT FIRE YOUR PURSUIT™ XT WITH EXCESS GREASE, OIL, OR OTHER MATERIAL IN THE BORE.** These lubricants or solvents can partially or fully obstruct the bore which could result in damage to the firearm or injury to the shooter and/or bystanders.

NOTE: Store your Pursuit™ XT uncharged and unprimed in a cool, dry, secured area. Storage in a gun case should be avoided as it may hasten condensation and corrosion. During long periods of storage, periodically check for signs of pitting or rusting on the surface and in the barrel.

 **WARNING: FIREARM SECURITY IS YOUR PERSONAL RESPONSIBILITY. ALWAYS SAFELY STORE AND SECURE YOUR FIREARM.** You must ensure that your firearms are securely and safely stored so that children and/or unauthorized users may not obtain them. Your firearms should always be kept unloaded and locked when not in use or in your immediate control. Never assume that the use of a lock alone is sufficient to safely secure your firearm. You must continually evaluate your personal situation and employ security systems that prevent children and unauthorized users from gaining access to your firearm. It is recommended that you secure bullets, loading components, and primers in a locked container separate from your firearms.

ADDITIONAL INFORMATION ON BREECH PLUGS

Your Traditions® Pursuit™ XT will come with the Accelerator Breech Plug™. Breech plugs will wear out over time and should be replaced periodically. We recommend that you purchase at least one extra breech plug for emergencies in the field or at the range.

Tips for Stuck Breech Plugs:

Important: Always make sure to lubricate the breech plug threads liberally with Traditions® breech plug grease before using your muzzleloader to help avoid having a stuck breech plug.

1. With the breech plug wrench fitted over the breech plug, actually try to tighten the plug and then rock it back and forth to loosen up the fouling.
2. Remove the barrel from the frame. Pour some hot water into the barrel and let it soak for about a 1/2 hour. Secure the barrel in a padded vise. Position the wrench onto the breech plug and remove. Be careful not to scald yourself with the hot water.
3. If you still cannot remove plug contact the Traditions® Customer Service Department.

19. INFORMATION ON BLACK POWDER & BLACK POWDER SUBSTITUTES.

⚠ WARNING: ALWAYS FOLLOW THE RECOMMENDED LOAD INFORMATION PROVIDED IN THIS BOOK OR BY THE POWDER OR BULLET MANUFACTURER. FAILURE TO DO SO COULD CAUSE INJURY AND/OR DEATH TO THE SHOOTER AND BYSTANDERS AND DAMAGE TO PROPERTY.

As a muzzleloading firearm shooter you become a reloader in addition to being the shooter. This adds another aspect of responsibility to you and requires that you to strictly adhere to the proper safe charging of your firearm regardless of what type of black powder or black powder substitute you use. Failure to properly follow these instructions and the powder manufacturer's recommendations may cause damage to the firearm and injury and/or death to the shooter or bystanders and damage to property.

As technology advances and innovation continues, new powders and primers may become available. This manual does not cover every powder, primer, or bullet that is on the market. For the most up to date information, visit www.traditionsfirearms.com, contact our customer service department, or check with the manufacturer if you have questions regarding a new powder, primer, or bullet.

⚠ DANGER: NEVER USE MORE THAN 150 GRAINS (OR THE EQUIVALENT) OF BLACK POWDER OF ANY TYPE FROM ANY MANUFACTURER.

BLACK POWDER

Black powder gunpowder is the original propellant of firearms and is still quite useful to this day. Black powder is generally available in four different granule sizes which determines the appropriate use for the powder. The burn rate of black powder depends on its grain size. Larger granules burn at a slower rate and therefore work best in large diameter rifles or cannons; while smaller granules burn at a faster rate and work best in small caliber rifles or pistols. Selecting the correct granulation is imperative for the best reliable performance of your muzzleloading firearm.

Note: When purchasing black powder make sure that the granulation or type is clearly marked on the manufacturer's container so you can assure you are purchasing the correct powder for your application.

FG (also referred to as 1Fg or Single “F”)

This is a very coarse black powder best suited to very large bore rifles and shotguns (10, 8, 4 gauge) that were produced in the past. This powder is one that you will not find very much use for and as such is not often seen for sale.

FFG (also referred to as 2Fg or Double “F”)

This is a popular granulation as it has a wide variety of applications. Suitable for rifles .50 caliber and over, black powder shotguns in 12, 16, and 20 gauge and sometimes in large caliber single shot pistols (larger than .50 caliber).

FFFG (also referred to as 3Fg or Triple “F”)

Since it can be used in a wide variety of applications this is the most popular and available granulation of black powder. Suitable for use in rifles and single shot pistols .50 caliber and under, as well as in all percussion (cap & ball) revolvers; this powder is the most versatile black powder available.

FFFFG (also referred to as 4Fg or Four “F”)

This is the finest of the commonly available black powders and with its fast burn rate has limited applications. The best and most common application of this powder is for the priming of the flash pan on a flintlock rifle. Since it has such limited applications it can sometimes be hard to find at retailers.

 **WARNING:** Traditional black powder is extremely flammable therefore proper handling and storage procedures from the manufacturer should be strictly followed. If you have any concerns or questions on how exactly to handle or store black powder contact the manufacturer of the powder. Additional information on black powder storage is available from the National Fire Protection Association, 1 Batterymarch Park, Quincy, MA. 02269. (www.nfpa.org). They can be contacted by calling 1-800-344-3555 or emailing custserv@nfpa.org. Ask for pamphlet #495 for information regarding black powder.

BLACK POWDER SUBSTITUTES

In addition to traditional black powder there are now a multitude of suitable black powder substitutes that are appropriate for use in Traditions® muzzleloading firearms. These powders can offer advantages over traditional black powder but sometimes require specific types of ignition and it is important to consult the powder manufacturer's instruction on appropriate ignition types.

Some black powder substitutes are offered in differing granulations similar to black powder, while others are only offered in one granulation. It is important that you select the appropriate powder and granulation for your specific application and firearm.

In addition most black powder substitutes relate closely to black powder on a volume to volume basis but not by weight. For this reason black powder substitutes are measured by volume as opposed to by weight. When using you a black powder measure you must follow the powder manufacturer's instructions on adjusting the measuring of the powder charge compared to what charge you would normally use with black powder.

Some black powder substitutes are also available in a pellet form which provides for easier carrying and loading. Pellets are sometimes offered in different charge sizes so be sure to use the appropriate number of pellets to obtain your desired charge. Consult the pellet manufacturer's recommendations if you have any doubts about how many pellets to use.

⚠ WARNING: DO NOT USE PYRODEX® CTG. While Pyrodex CTG is a black powder substitute, it is designed to be used in cartridge firearms which use cartridges that originally used black powder as their charge. It is not safe or recommended for use in muzzleloading firearms.

TYPES OF BLACK POWDER & BLACK POWDER SUBSTITUTES

Traditions® does not sell or endorse any specific brand of black powder or black powder substitute. However listed below are some of the currently available black powder or black powder substitutes that are approved for use in Traditions® products. Please refer to the powder manufacturer for proper loading and measuring techniques as they can vary from manufacturer to manufacturer. If there is ever a question on the appropriate application of a certain powder or the safety of a specific powder charge you must contact the manufacturer of the powder as the source for this information.

Follow the safe handling and storage precautions printed on the manufacturer's container and never purchase or use any powder that has been removed from their manufacturer's original container.

⚠ DANGER: NEVER UNDER ANY CIRCUMSTANCE USE SMOKELESS POWDER OF ANY TYPE OR IN ANY QUANTITY IN A MUZZELOADING FIREARM, AND NEVER MIX POWDERS. The use of any smokeless powder at all could result in a detonation or explosion which could cause injury and/or death to the shooter or bystanders and damage to property.

⚠ WARNING: NEVER EXCEED THE RECOMMENDED MAXIMUM BLACK POWDER OR BLACK POWDER SUBSTITUTE CHARGE LISTED IN THIS BOOK OR BY THE POWDER MANUFACTURER. If the recommended maximum charge is exceeded then injury or death to the shooter or bystanders can occur.

⚠ WARNING: FOLLOW THE POWDER MANUFACTURER'S INSTRUCTIONS WHEN MEASURING ANY TYPE OF POWDER AS NOT ALL POWDERS ARE MEASURED THE SAME. SOME ARE MEASURED BY WEIGHT AND SOME BY VOLUME, AND VOLUMETRIC MEASURING CAN VARY DEPENDING ON THE TYPE AND MANUFACTURER OF THE POWDER.

Use the below table to find out more about some of the available black powders and black powder substitutes from the following companies:

Brand	Product	Website
Alliant Powder®	Black MZ®	www.alliantpowder.com
American Pioneer Powder®	Shockey's Gold®	www.americanpioneerpowder.com
Goex®	Goex®	www.goexpowder.com
Hodgdon®	Pyrodex®	www.hodgdon.com
Hodgdon®	Triple Seven®	www.hodgdon.com
IMR®	White Hots®	www.imrpowder.com
Hodgdon®	Blackhorn 209®	www.blackhorn209.com

209 Primer Suggestions

Traditions® does not sell or endorse any specific brand of 209 primers. For the most up to date information on suggested primers, please visit www.traditionsfirearms.com, contact our customer service department, or check with the primer manufacturer.

For more information regarding primers contact the primer or powder manufacturer and make sure you use an appropriate primer for the powder you are using.

While most models take a 209 primer, Traditions® does carry models, like the Northwest Magnum series, which take a musket cap. If you are unsure of which primer your muzzleloader takes please contact Traditions® customer service department.

20. SUGGESTED LOADS FOR THE PURSUIT™ XT

 **WARNING:** 8 C' B C H' @ 5 8 ' C F ' : † 9 ' 5 B M D F C > 9 7 H † @ G ' H < 5 H ' 5 F 9 ' B C H ' 5 D D F C J 9 8 ' 6 M H F 5 8 † † C B G ' : † 9 5 F A G ' 8 I 9 ' H C ' 9 L 7 9 G G † J 9 ' D F 9 G G I F 9 G " † B > I F M 5 B 8 † C F ' 8 9 5 H < ' H C ' H < 9 ' G < C C H 9 F ' C F ' 6 M G H 5 B 8 9 F G ' 5 B 8 ' 8 5 A 5 ; 9 ' H C ' D F C D 9 F H M A 5 M C 7 7 I F " J † G † H ' K K K ' H F 5 8 † † C B G : † 9 5 F A G ' 7 C A " .

 **WARNING: NEVER EXCEED THE RECOMMENDED MAXIMUM BLACK POWDER OR BLACK POWDER SUBSTITUTE CHARGE LISTED IN THIS BOOK OR BY THE POWDER MANUFACTURER.** If the recommended maximum charge is exceeded then injury or death to the shooter or bystanders can occur.

 **WARNING: DO NOT USE PATCHED ROUND BALLS, CONICALS, OR MINIE BALLS.**

 **WARNING: BE SURE ONLY ONE PROJECTILE IS LOADED IN THE BARREL. DO NOT LOAD A PROJECTILE ON TOP OF ANOTHER. INJURY AND/OR DEATH TO THE SHOOTER OR BYSTANDERS AND DAMAGE TO PROPERTY MAY OCCUR.**

 **WARNING: FOLLOW THE POWDER MANUFACTURER'S INSTRUCTIONS WHEN MEASURING ANY TYPE OF POWDER AS NOT ALL POWDERS ARE MEASURED THE SAME. SOME ARE MEASURED BY WEIGHT AND SOME BY VOLUME. VOLUMERIC MEASURING CAN VARY DEPENDING ON THE TYPE AND MANUFACTURER OF THE POWDER**

 **WARNING: NEVER UNDER ANY CIRCUMSTANCE USE SMOKELESS POWDER OF ANY TYPE OR IN ANY QUANTITY IN A MUZZLELOADING FIREARM, AND NEVER MIX POWDERS.** The use of any smokeless powder at all could result in a detonation or explosion which could cause injury and/or death to the shooter or bystanders and damage to property.

There are many projectiles in the marketplace which would be appropriate for use in the Pursuit™ XT. Be sure it is a bullet that is specific for muzzleloaders or has been rated for muzzleloader use. Bullets are ever changing and there may be new bullets on the market that are not on our suggested list. Please visit www.traditionsfirearms.com for full ballistic information or contact our customer service department with any questions regarding which projectiles are best used in your Pursuit™ XT.

For a full ballistics chart, visit
www.traditionsfirearms.com.

PYRODEX OR TRIPLE SEVEN BLACK POWDER SUBSTITUTE PELLETS

Bullet Weight	Sabot/Bullet Dia.	Powder	Powder Charge	Velocity FPS
250 gr. Smackdown	50/45	Pyrodex Pellets	2-50 Grain Pellets	1785
250 gr. Smackdown	50/45	777 Pellets	2-50 Grain Pellets	1785
250 gr. Smackdown	50/45	White Hots Pellets	2-50 Grain Pellets	1714
305 gr. Smackdown	50/45	White Hots Pellets	2-50 Grain Pellets	2030

Note: Velocities listed are from use with the Smackdown Carnivore Bullet in 250 grain and the Smackdown XR Bullet in 305 grain. The velocities are approximate and for reference only.

BLACKHORN 209, PYRODEX, TRIPLE SEVEN, BLACK POWDER SUBSTITUTES

 **WARNING: POWDER CHARGES MEASURED IN VOLUMETRIC UNITS, NOT BY WEIGHT.**

Bullet Weight	Sabot/Bullet Dia.	Powder	Powder Charge	Velocity FPS
250 gr. Smackdown	50/45	777 Powder 2F or 3F	80 gr. VU Min.	1681
250 gr. Smackdown	50/45	777 Powder 2F or 3F	100 gr. VU Max.	1835
250 gr. Smackdown	50/45	Blackhorn 209	80 gr. VU Min.	1734
250 gr. Smackdown	50/45	Blackhorn 209	120 gr. VU Max.	2120
305 gr. Smackdown	50/45	Blackhorn 209	80 gr. VU Min.	1620
305 gr. Smackdown	50/45	Blackhorn 209	120 gr. VU Max.	2030
250 gr. Smackdown	50/45	Pyrodex RS Powder	80 gr. VU Min.	1550
250 gr. Smackdown	50/45	Pyrodex RS Powder	100 gr. VU Max.	1706

Note: Velocities listed are from use with the Smackdown Carnivore Bullet in 250 grain and the Smackdown XR Bullet in 305 grain. The velocities are approximate and for reference only.

21. SCOPE MOUNTING & SIGHTING IN

The Traditions® Pursuit™ XT comes drilled and tapped for easy installation of mounts and a scope and may come with a scope already mounted depending on the model.

 WARNING: DO NOT DRILL EXTRA HOLES IN YOUR BARREL. This can cause weakening of the barrel and the possibility of the barrel rupturing and/or bursting, resulting in injury or death to you or others.

Traditions® recommends using Traditions® scope bases and rings for mounting your scope as they are designed for your firearm. If you need to purchase new mounts and rings you can do so at your local dealer or on www.traditionsfirearms.com. Please contact Traditions® Customer Service Department with any questions about proper mounts and rings for your firearm.

Securing Scope Bases to Your Barrel

Use the Allen wrench provided with your Pursuit™ XT to secure scope bases to your firearm. You should also use the Allen wrench for tightening the screws on the scope rings which should be finger-tight. Overtightening the screws can cause stripped threads and/or bent and distorted mounts. Using Loctite® and other threading compounds is encouraged but not a requirement.

Mounting Your Scope

Traditions® offers a wide variety of scopes and mounting options to suit many needs. Visit www.traditionsfirearms.com to see our full line of optics and mounts or a dealer near you.

When mounting your scope, please take precaution in ensuring that your front objective lens bell is not touching the firearm and that your eyepiece has clearance from your hammer or cocking mechanism.

 WARNING: MAKE SURE THAT YOUR EYE RELIEF IS SUCH THAT YOU HAVE A COMFORTABLE AIMING POSITION BUT THAT YOU HAVE AN APPROPRIATE DISTANCE FROM YOUR EYE SO THAT YOU ARE NOT STRUCK BY THE SCOPE UNDER RECOIL WHILE SHOOTING.

Rifle Scope Adjustment

Rifle scopes have two turrets of adjustment for adjusting the point-of-aim for the shooter. Adjustment for elevation is on the top of the scope and windage is typically found on the right-hand side of the scope when mounted on the Pursuit™ XT.

 WARNING: ALWAYS FOLLOW SCOPE MANUFACTURER'S MOUNTING INFORMATION AND DIRECTIONS.

Bore Sighting A Break Action Firearm

1. Check to ensure the barrel is unloaded and has no obstructions.
2. Remove your barrel from the firearm and carefully place it with the mounted scope on a sandbag or shooting vise.
3. Looking down the bore from the breech side, move your barrel to where the center of your target is in the middle of the field of vision.
NOTE: You can use a bore sighter for this process as well.

Sighting-In Your Firearm

1. Once bore-sighted, install your barrel back on your firearm. Place the firearm on your sandbag or shooting vise and fire a minimum of two shots at the bullseye.
2. Without moving the firearm, observe your shot group and its relation to the bullseye (or point of aim.)
3. Carefully adjust your scope's crosshairs with the turrets to the center of the shot group. Most hunting scopes adjust 1/4 inch per click at 100 yards. 50 yards is 1/8" and 200 yards is 1/2" per click.
4. Once your scope is adjusted to the point of impact, carefully move your firearm back to the bullseye as the point of aim.
5. Fire another shot group to determine if the point of impact is in alignment with your aim.
6. If you wish to zero at a greater distance, consult ballistic data for the load you are firing and repeat this process at that given distance.

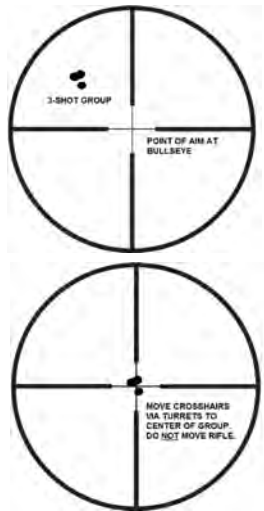

22. WARRANTY & SERVICE

LIMITED LIFETIME MECHANICAL WARRANTY

Traditions® will warrant this firearm to be free of mechanical defects in materials or craftsmanship for the life of the firearm while in the possession of the original owner except composite stocks, wood stocks, and finishes. Traditions® will repair or replace, at its own option, product or parts which are returned at owner's expense to the Traditions® Customer Service Department. Call 860-388-4656 to obtain a factory issued Return Merchandise Authorization number. A full explanation of the specific problem must be given to the customer service representative.

This warranty shall remain in force unless any of the following are determined by the Traditions® Customer Service Department:

1. Normal wear from regular and intended use.
2. Use of any propellant other than black powder or approved black powder substitutes.
3. Use of any powder charge in excess of those recommended in this booklet or by the powder manufacturer.
4. Use of any plastic patching material with round balls.
5. Modification of internal parts as they were shipped from the factory.
6. A lack of proper maintenance and thorough cleaning is evident such as rust.
7. Peeling of camo finish after 1 year of service.
8. Failure to comply with the instructions listed here in the owner's manual.
9. Customer abuse.

Traditions® specifically disclaims any and all warranties other than those listed above on this page to the fullest extent allowed under applicable law, including warranties of merchantability and/or fitness for a particular purpose. This warranty applies only to the firearm. It does not apply to any accessories.

NOTE: Proof of purchase is required to show original ownership for all warranty work.

PLEASE HELP US SERVE YOU BETTER

In the event you should have questions pertaining to the function or performance of your new Traditions® firearm please visit our website to get answers to the most commonly asked questions. Log on to www.traditionsfirearms.com where you will find the FAQ page. This page will get you fast access to trouble shooting solutions. If you do not find an answer to your specific question on the FAQ page of our website please feel free to email info@traditionsfirearms.com and a qualified member of our team will respond to your individual question as quickly as possible. Additionally, there are numerous videos on our website that can help answer questions regarding your firearm. Visit www.traditionsfirearms.com/video-listings or <https://www.youtube.com/user/TraditionsFirearm>.

In the event you still need assistance please do not hesitate to contact Traditions®, and a member of our Customer Service Department will be happy to assist.

In the unlikely event you need warranty service on your firearm we need your help to get the work done right and without delay. It is simple to send an email or give us a call to discuss the issue.

Traditions® conveniently engraves the caliber, serial number and model name on each firearm. Take note of this information, record it on the warranty page in this manual and be prepared to state it when contacting the Traditions® Customer Service Department with your questions.

Steps to Return a Rifle for Service

1. Do not return your firearm to the dealer.
2. Please call us and describe the problem. Chances are we can either guide you to a solution right over the phone or when possible send you the parts you need to correct the problem. Should your firearm need factory service, we will give you instructions about where to ship it and issue you a Return Merchandise Authorization number.
3. All firearms must have a factory issued Return Merchandise Authorization number (RMA) before returning to Traditions® for warranty service. Firearms without an RMA number will be refused.

4. Package your unloaded firearm safely and securely inside a sturdy box. The Traditions® box your firearm arrived in is NOT a shipping box. **NOTE: Firearms packaged and shipped improperly are not covered under warranty if damage occurs.**
5. Write your RMA # on the outside of the box so it can be easily seen when it arrives at our facility.
6. Ship your unloaded firearm to:
Traditions®
1375 Boston Post Rd. • P.O. Box 776
Old Saybrook, CT 06475-0776

 **WARNING: It is in violation of Federal Law to ship a loaded firearm. If your firearm has a live charge and/or projectile in the barrel, please take it to a local gunsmith for removal or call Traditions® Customer Service Department at 860-388-4656.**

 **ATTENTION: YOUR FIREARM MUST BE CLEANED BEFORE IT CAN BE INSPECTED.** If we need to clean your firearm in order to inspect it there will be a standard cleaning, lubrication, inspection, and function test (C.L.I.F.) service fee.

NOTE ON ACCESSORIES:

Please remove all after-market accessories from your firearm prior to sending in for repairs. This will ensure that these items will not be lost, misplaced, or damaged during the return process.

TRADITIONS® WILL NOT BE HELD LIABLE FOR ANY AFTER-MARKET ITEMS OR ACCESSORIES THAT ARE LOST OR DAMAGED IF THEY ARE NOT REMOVED AND ARE SENT IN ON YOUR TRADITIONS® ITEM COMING BACK FOR REPAIR.

FOR YOUR RECORDS

Important: Please record information here and keep for your record.

Model No. _____

Serial No. _____

Model Name _____

Caliber _____

Date Purchased _____

From _____

Registration Card mailed on _____

Please call Traditions® Customer Service Department at 860-388-4656 with any questions or concerns.

To register your warranty online please go to www.traditionsfirearms.com/support/warranty-registration or you can mail in the warranty card in this manual.

To be added to our email list for announcements, specials, and other information please visit our website at: www.traditionsfirearms.com.

01/21 AKH

PREFERRED CUSTOMER WARRANTY REGISTRATION CARD



Referencing the label on the end of the carton, please write in the last 5 digits located on the right half of the UPC code into the boxes below.

UPC #

4	0	5	8	9	-					
---	---	---	---	---	---	--	--	--	--	--

Model# _____

Serial# (from barrel) _____

Name _____ Age _____

Street _____

City _____ State _____ Zip _____

Day Time Phone # _____ Date of Purchase _____

Purchase Price _____ Store Name _____

1. **What is your age?** Under 18 18-24 25-34 35-44 45-54 55-64 over 65
2. **Reason for your purchase** Hunting Target Shooting Personal use Gift
 Raffle Prize Other
3. **Do you own?** Muzzleloaders Over/Under Shotgun Side by Side Shotgun
 Semi-Auto Shotgun Pump Shotgun Cartridge Rifle Handgun Bow
4. **Where purchased?** Gun Shop General Sporting Goods Store Hardware Store
 Chain Store Mail Order Catalog Internet Store
5. **Which factors influenced your purchase?** Previously owned a *Traditions* product
 Magazine Ad/Article Website *Traditions* Catalog Recommendation of Salesperson
Recommendation of a Friend Price Features Other
6. **What type of game do you hunt?** Whitetail Deer Mule Deer Elk Bear
 Antelope Turkey Small Game Other
7. **What do you think is the best way to get information about Hunting & Hunting products?**
Magazine Ads Internet/Website Television Programs Radio
8. **Which magazine/s do you read?** _____
9. **Which TV hunting shows do you watch?** _____

To be added to our email list to receive *Traditions*® emails including giveaways, product information, and more please provide your email address:

NOTE: Return this card within 15 days of purchase in order to validate your warranty.

Please complete all information above and mail to:



P.O. Box 776 • Old Saybrook, CT 06475-0776

www.traditionsfirearms.com

© 2021 *Traditions*® Performance Firearms. All Rights Reserved.

Cut Along Dotted Line



P.O. Box 776
Old Saybrook, CT 06475-0776

**Place
Postage Here.**
Or for additional
security enclose
in a envelope.