

M&P[®]

by **Smith & Wesson[®]**

Safety & Instruction Manual

M&P SHIELD[®]



M&P SHIELD[®] M2.0[™]

NOTE: There is a separate manual for M&P SHIELD[®] EZ[®] pistols.
Available free upon request or via download from
www.smith-wesson.com



**Read the instructions and
warnings in this manual
CAREFULLY BEFORE
using this firearm.**

2100 Roosevelt Avenue • Springfield, MA 01104

1-800-331-0852 • Fax: 413-747-3317

www.smith-wesson.com

Copyright © 2019 Smith & Wesson Inc.
All rights reserved.



**WARNING:
READ THESE**



**INSTRUCTIONS AND
WARNINGS CAREFULLY.**

**BE SURE YOU UNDERSTAND THESE
INSTRUCTIONS AND WARNINGS
BEFORE USING THIS FIREARM.**

**FAILURE TO READ THESE
INSTRUCTIONS AND TO FOLLOW
THESE WARNINGS MAY RESULT
IN SERIOUS INJURY OR DEATH
TO YOU AND OTHERS AND
DAMAGE TO PROPERTY.**

**THIS SAFETY & INSTRUCTION
MANUAL SHOULD ALWAYS
ACCOMPANY THIS FIREARM AND
BE TRANSFERRED WITH IT UPON
CHANGE OF OWNERSHIP OR WHEN
PRESENTED TO ANOTHER PERSON.**

**A COPY OF THE SAFETY &
INSTRUCTION MANUAL IS
AVAILABLE FREE VIA DOWNLOAD AT
WWW.SMITH-WESSON.COM
OR UPON REQUEST FROM:**

**SMITH & WESSON®
CUSTOMER SUPPORT CENTER
2100 ROOSEVELT AVENUE
SPRINGFIELD, MA 01104
TEL.: 1-800-331-0852, ext. 4125
E-mail: qa@smith-wesson.com**

TABLE OF CONTENTS

YOUR SAFETY RESPONSIBILITIES	3-6
SAFE STORAGE AND TRANSPORTATION	7-8
AMMUNITION	9-11
MODEL AND FEATURES IDENTIFICATION	12-13
INSPECTING YOUR PISTOL	14-15
LOADED CHAMBER INDICATOR	16
MANUAL THUMB SAFETY LEVER (If so-equipped)	17
MAGAZINE SAFETY (If so-equipped)	18
PORTED BARREL WARNINGS (If so-equipped)	19
PREPARATION FOR FIRING	20
LOADING	21-23
FIRING	23-24
CLEARING MISFIRES	25
UNLOADING	26
FIELD STRIPPING / DISASSEMBLY	27-29
LUBRICATION	29
ASSEMBLY	30-31
SIGHT ADJUSTMENT	32
MAGAZINE	33-36
CLEANING AND MAINTENANCE	37-39
LIMITED WARRANTY	40-41
CONTACT AND SHIPPING INFORMATION	42-43
INTEGRAL CRIMSON TRACE® LASER ADDENDUM	44-55
SHIELD MINI OPTICAL SIGHT ADDENDUM	56-64
CUSTOM SERVICE	66
BATTERY WARNINGS	67
PATENT INFORMATION, INT'L WARRANTY CENTERS	68

YOUR SAFETY RESPONSIBILITIES

SAFETY IS YOUR NUMBER ONE RESPONSIBILITY!

- At home, in the field, at the range, or anywhere, the first concern of every firearm owner should be safety. Apply the following safety rules in every situation, with any kind of firearm. If you feel uncertain about any operational aspects of your firearm, please contact Smith & Wesson at 1-800-331-0852, ext. 4125 before proceeding with its operation.
- If you are unfamiliar with firearms you should seek formal training before using your pistol.



WARNING: YOU MUST FOLLOW ALL OF THESE SAFETY RULES TO ENSURE THE SAFE USE OF YOUR FIREARM. THE FAILURE TO FOLLOW THE INSTRUCTIONS AND WARNINGS IN THIS MANUAL COULD CAUSE SERIOUS PERSONAL INJURY OR DEATH TO YOU OR OTHERS AND DAMAGE TO PROPERTY.

- As a firearm owner, you accept a demanding responsibility. How seriously you take this responsibility can be the difference between life and death. There is no excuse for careless or abusive handling of your firearm. At all times handle your firearm with intense respect for its power and potential danger.

YOUR SAFETY RESPONSIBILITIES CONTINUED

- **ALWAYS KEEP YOUR FIREARM POINTED IN A SAFE DIRECTION.** Never point a firearm at anyone or anything you do not intend to shoot whether or not it is loaded. This is particularly important when loading, unloading, or field stripping the gun. ALWAYS control the direction of the firearm.
- **ALWAYS TREAT EVERY FIREARM AS IF IT IS LOADED AND WILL FIRE.** Do not take anyone's word that the firearm is unloaded – always check for yourself. Never pass your firearm to another person until the cylinder or action is open and you visually check that it is unloaded. Keep your firearm unloaded and safely stored when not in use.
- **NEVER PLACE YOUR FINGER INSIDE THE TRIGGER GUARD OR ON THE TRIGGER UNLESS YOU INTEND TO FIRE.** Ensure that other objects do not touch the trigger.
- **ALWAYS BE SURE OF YOUR TARGET AND WHAT IS BEYOND IT.** Always be sure of where the bullet will strike and shoot only where there is a safe back stop free of obstructions, water or other surfaces which can cause ricochets. Be sure your bullet will stop behind your target. Bullets can glance off many surfaces like rocks or the surface of water and travel in unpredictable directions with considerable velocity. Do not fire randomly into the sky.
- **NEVER CROSS OBSTACLES SUCH AS FENCES OR STREAMS WITH A LOADED FIREARM.** Always make certain your firearm is unloaded before crossing a fence, climbing a tree, jumping a ditch or negotiating other obstacles.
- **SAFE GUN HANDLING IS YOUR PERSONAL RESPONSIBILITY AT ALL TIMES.** Firearms are dangerous and can cause serious injury or death if they are misused or used inappropriately. Safety must be the prime consideration of any one who owns or handles firearms. Accidents are the result of violating the rules of safe gun handling and common sense. Firearm safety training is available. Contact your firearms dealer, law enforcement agency, local sportsman's club, etc. for availability.
- **YOU ARE RESPONSIBLE FOR THE FIREARM AT ALL TIMES.** In owning a firearm, you must undertake full-time responsibility for your firearm's safety and security. You must protect yourself and all others against injury or death from misuse of the firearm 24 hours a day.
- **FIREARM SECURITY IS YOUR RESPONSIBILITY.** You must secure firearms safely from children and/or unauthorized users. Your firearm should always be kept unloaded and locked when not in use. A lock has been provided for this purpose. Never assume that the use of this lock is sufficient to safely secure your firearm. You must always evaluate your personal situation and employ the security systems that meet your needs and prevent children and unauthorized users from gaining access to your firearm.

YOUR SAFETY RESPONSIBILITIES CONTINUED

- **APPROPRIATE USE FOR YOUR FIREARM MEANS USING YOUR FIREARM FOR LEGAL PURPOSES.** For example - target shooting, hunting and lawful resistance of deadly criminal force. It is your responsibility to ensure that you are in compliance with all applicable laws and ordinances regarding the use of your firearm.
- **NEVER RELY ON MECHANICAL FEATURES ALONE.** Only your safe gun-handling habits will ensure the safe use of your firearm. This is your responsibility.
- **ALWAYS SAFELY STORE AND SECURE YOUR FIREARM.** Safe and secure storage of your firearm is one of your most important responsibilities. It is a full-time responsibility. You must always secure your firearm and ammunition separately so that they are not accessible to children and/or other unauthorized persons.
- **NEVER KEEP AMMUNITION IN THE SAME LOCATION AS THE FIREARM.** Store each in a separate and secure place.
- **ALWAYS WEAR EYE PROTECTION THAT IS SPECIFIED FOR USE WITH FIREARMS** every time you handle your firearm for cleaning and maintenance.
- **ALWAYS WEAR EYE AND HEARING PROTECTION THAT ARE SPECIFIED FOR USE WITH FIREARMS** every time you discharge your firearm. Make sure others in the vicinity of where you will be shooting do so as well.
- **NEVER USE ALCOHOL OR DRUGS BEFORE OR WHILE SHOOTING.** Do not use your firearm if you are on any medication which impairs, even slightly, your mental or physical ability.
- **ALWAYS HAVE ADEQUATE VENTILATION.** Discharging firearms in poorly ventilated areas, cleaning firearms, or handling ammunition may result in exposure to lead and other substances known to cause birth defects, reproductive harm, and other serious physical injury. Review the warnings and labels for all ammunition and cleaning products carefully. Wash hands thoroughly after exposure.
- **BEFORE HANDLING ANY FIREARM, UNDERSTAND ITS OPERATION.** Not all firearms are the same. Familiarize yourself with the mechanical features of any firearm you intend to use. If you feel uncertain about any operational aspects of your firearm, please contact Smith & Wesson® at 1-800-331-0852, ext. 4125 before proceeding with its operation.
- **NEVER ALLOW A FIREARM TO BE USED BY INDIVIDUALS WHO DO NOT UNDERSTAND ITS SAFE OPERATION OR HAVE NOT READ THESE FIREARM SAFETY RULES.**

YOUR SAFETY RESPONSIBILITIES CONTINUED

- **ALWAYS USE THE CORRECT AMMUNITION FOR YOUR PARTICULAR FIREARM** as indicated by the marking on the barrel. Never use non-standard, reloaded, or “handloaded” ammunition which has not been subjected to internal ballistic pressure testing.
- **BEWARE OF BARREL OBSTRUCTIONS.** Be sure the barrel is clear of obstructions before shooting. Mud, water, snow or other objects may inadvertently lodge in the barrel bore. A small obstruction can cause a dangerous increase in pressure and may damage your gun and cause injury to yourself and others.
- **BE SURE ALL ACCESSORIES, SUCH AS HOLSTERS, GRIPS, SLINGS, SCOPES AND OTHER ACCESSORIES ARE COMPATIBLE** with the firearm and that the accessories do not interfere with safe operation. It is your responsibility to understand and follow all of the instructions in this manual, as well as those which may be supplied with your ammunition and any accessory.
- **NEVER DISASSEMBLE YOUR FIREARM** beyond the field stripping procedure outlined in this manual. Improper disassembly or reassembly of your firearm may be dangerous and can lead to serious injury or death.
- **NEVER MANIPULATE, ADJUST OR CHANGE ANY OF THE INTERNAL COMPONENTS OF YOUR FIREARM UNLESS SPECIFICALLY INSTRUCTED TO DO SO IN THIS MANUAL.** Improper manipulation of any other internal component may affect the safety and reliability of your firearm and may cause serious injury or death.
- **NEVER ALLOW ANY ALTERATION OR REPLACEMENT OF PARTS IN YOUR SMITH & WESSON® FIREARM UNLESS PERFORMED BY A QUALIFIED GUNSMITH** using genuine Smith & Wesson parts. If you do otherwise, improper functioning of your firearm may occur and serious injury or death and damage to property may result.



WARNING: SAFE USE OF A FIREARM IS YOUR PERSONAL RESPONSIBILITY AND THE FAILURE TO FOLLOW ALL OF THESE BASIC SAFETY RULES MAY RESULT IN SEVERE PERSONAL INJURY OR DEATH TO YOU OR OTHERS AND DAMAGE TO PROPERTY. YOU ARE THE MOST IMPORTANT SAFETY DEVICE WHEN IT COMES TO THE USE OF YOUR FIREARM AND SMITH & WESSON® WILL NOT BE RESPONSIBLE FOR ANY PERSONAL INJURY, DEATH OR PROPERTY DAMAGE THAT RESULTS FROM:

(1) THE CRIMINAL OR NEGLIGENT USE OF THIS FIREARM; (2) A DISREGARD OF THESE SAFETY INSTRUCTIONS AND WARNINGS; (3) IMPROPER OR CARELESS HANDLING OF THIS FIREARM; (4) THE USE OF NON-STANDARD, DEFECTIVE OR IMPROPER AMMUNITION; (5) OR, IMPROPER OR NEGLIGENT MODIFICATIONS OR REPAIRS TO THE FIREARM.

SAFE STORAGE AND TRANSPORTATION



WARNING: ALWAYS POINT THE MUZZLE IN A SAFE DIRECTION.



WARNING: FIREARMS ARE DANGEROUS WHEN USED AND STORED IMPROPERLY. THEY POSE A RISK OF SERIOUS OR FATAL INJURIES. FIREARMS CAN BE ESPECIALLY DANGEROUS TO CHILDREN WHEN THEY ARE STORED IN AN IRRESPONSIBLE AND UNSAFE MANNER. FOR YOUR SAFETY AND THE SAFETY OF OTHERS, IT IS IMPERATIVE THAT YOU KEEP YOUR FIREARM LOCKED AND UNLOADED IN A SECURE PLACE. THE AMMUNITION SHOULD BE STORED IN A SEPARATE, SECURE LOCATION WHEN IT IS NOT IN USE. SAFE AND SECURE STORAGE OF YOUR FIREARM IS ONE OF THE MOST IMPORTANT RULES OF FIREARM SAFETY. YOUR FAILURE TO FOLLOW THESE RULES MAY RESULT IN SERIOUS INJURY OR DEATH TO YOU OR OTHERS.

- **ALWAYS SECURE YOUR FIREARM IN A MANNER THAT WILL PREVENT UNAUTHORIZED ACCESS.** Whenever your firearm is not in use, keep it unloaded and locked. Your safety and the safety of others requires that you always secure and store your firearm in a manner that will prevent unauthorized access. Never leave a firearm unattended unless it is locked, unloaded and secured.
- **ALWAYS USE THE LOCK PROVIDED BY SMITH & WESSON TO SECURE YOUR FIREARM.** Please read and follow the instructions packaged separately for the use of this lock. A lock, when properly used, can be an effective tool in preventing unauthorized access to your firearm. There are other alternative locks and safe storage containers available in the marketplace which may also be appropriate for your particular needs. Consult your local gun shop, hardware store, or local police department for guidance on the variety of other safe storage devices or practices which may be appropriate for your particular needs. By purchasing this firearm you have accepted the responsibility of safely securing the firearm at all times and preventing its unauthorized use. Never assume that the use of this lock alone is sufficient to safely secure your firearm. It is your personal responsibility to select and use whatever measures or practices that will enable you to be absolutely certain that your firearm is secure at all times.



WARNING: NEVER LOCK A LOADED FIREARM AND NEVER LOAD A LOCKED FIREARM!!

SAFE STORAGE AND TRANSPORTATION CONTINUED

- **ALWAYS STORE YOUR FIREARM AND AMMUNITION SEPARATELY** so that they are not accessible to children or other unauthorized persons. Safe and secure storage of your firearm and ammunition are your responsibility. It is a full-time responsibility.
- **NEVER ASSUME THAT A “HIDING” PLACE IS A SECURE STORAGE METHOD.** Others may be aware of your storage location or come upon it by chance. It is your personal responsibility to use common sense when storing your firearm and ammunition and to always make sure they are not accessible to children or other unauthorized persons.
- **NEVER TRANSPORT A LOADED FIREARM.** When transporting your firearm, be sure it is unloaded and locked. Safe and secure transportation of your firearm is your responsibility.
- **ALWAYS FOLLOW THE LAW!** Many jurisdictions have laws that make it a crime to keep a firearm unlocked and in an area accessible to children or others. Keeping a firearm locked and unloaded when not in use is not only common sense safety practice... IT IS THE LAW. You must be familiar with all local, state, and federal laws regarding the safe storage and transportation of your firearm. Failure to know and follow the law may result in unauthorized access or use of your firearm by another. Obey all laws relating to the storage and transportation of firearms. Your local police department or gun shop can furnish you with available information on storing and/or transporting a firearm safely and legally.
- **YOUR FIREARM IS YOUR RESPONSIBILITY.** You must prevent your firearm from being stolen or from being used by untrained or unqualified individuals. Keep it locked, unloaded and secured when not in use.

AMMUNITION



WARNING: NEVER USE AMMUNITION NOT SPECIFICALLY DESIGNATED FOR USE IN YOUR FIREARM. FAILURE TO USE THE CORRECT TYPE OR CALIBER OF AMMUNITION MAY CAUSE THE FIREARM TO JAM, OR FAIL TO FIRE, OR MAY GENERATE EXCESSIVE PRESSURE WHICH CAN DAMAGE OR EVEN RUPTURE YOUR FIREARM, CAUSING PERSONAL INJURY OR DEATH TO THE SHOOTER OR BYSTANDERS.

- Locate the cartridge designation marked on the firearm. This information indicates the correct ammunition that must be used in this firearm (FIGURE 1).

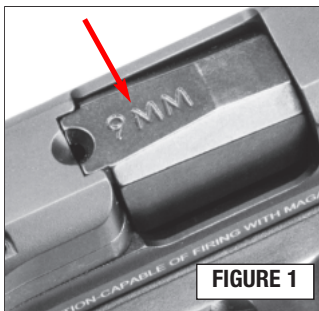

- You are responsible for selecting ammunition that meets industry standards and is appropriate in type and caliber for this firearm.

- Never mix ammunition.



WARNING: IN SOME CASES, A ROUND OF AMMUNITION NOT SPECIFIED ON YOUR FIREARM AND NOT LISTED AS ALTERNATE AMMUNITION IN THIS MANUAL, MAY FIT INTO THE CHAMBER. FIRING THIS AMMUNITION MAY CAUSE A RUPTURE RESULTING IN DAMAGE TO THE FIREARM AND PERSONAL INJURY OR DEATH TO THE SHOOTER OR BYSTANDERS. FOR MORE INFORMATION REGARDING UNSAFE CALIBER COMBINATIONS, REFER TO THE FOLLOWING URL:

[HTTPS://SAAMI.ORG/TECHNICAL-INFORMATION/UNSAFE-FIREARM-AMMUNITION-COMBINATIONS/](https://saami.org/technical-information/unsafe-firearm-ammunition-combinations/)



WARNING: ALWAYS INSPECT YOUR AMMUNITION BEFORE USING IT. NEVER USE DIRTY, CORRODED OR DAMAGED AMMUNITION. A BURST CARTRIDGE MAY RESULT CAUSING DAMAGE TO THE FIREARM AND PERSONAL INJURY OR DEATH TO THE SHOOTER OR BYSTANDERS.

- Use only commercially manufactured ammunition with internal ballistic pressures which are in strict accordance with the specifications of the Sporting Arms and Ammunition Manufacturers' Institute (SAAMI). If you are uncertain, contact your ammunition supplier for verification.



WARNING: DISCHARGING FIREARMS IN POORLY VENTILATED AREAS, CLEANING FIREARMS, OR HANDLING AMMUNITION MAY RESULT IN EXPOSURE TO LEAD AND OTHER SUBSTANCES KNOWN TO CAUSE BIRTH DEFECTS, REPRODUCTIVE HARM, AND OTHER SERIOUS PHYSICAL INJURY. HAVE ADEQUATE VENTILATION AT ALL TIMES. WASH HANDS THOROUGHLY AFTER EXPOSURE.

AMMUNITION CONTINUED



WARNING: NEVER USE NON-STANDARD, RELOADED OR “HANDLOADED” AMMUNITION WHICH HAS NOT BEEN SUBJECTED TO INTERNAL BALLISTIC PRESSURE TESTING. RELOADED OR HANDLOADED AMMUNITION, MAY HAVE MANY MANUFACTURING AND QUALITY VARIABLES (SUCH AS THE TYPE AND AMOUNT OF GUN POWDER). CARTRIDGE CASES THAT HAVE BEEN RELOADED AND FIRED MULTIPLE TIMES MAY SUFFER PHYSICAL DAMAGE WHICH COULD SIGNIFICANTLY IMPACT OR REDUCE THE INTEGRITY OF THE CARTRIDGE, POSSIBLY RESULTING IN BULLET SETBACK OR UNSEATING. CASE FAILURE AND INJURY TO THE SHOOTER OR BYSTANDERS AND DAMAGE TO THE FIREARM MAY RESULT WHEN SUCH A ROUND IS FIRED. ANY AMMUNITION THAT IS IMPROPERLY MANUFACTURED OR RELOADED, EVEN IN THE SLIGHTEST DEGREE, MAY FAIL TO FIRE OR MAY GENERATE EXCESSIVE INTERNAL PRESSURES WHICH CAN DAMAGE OR EVEN RUPTURE THE FIREARM, CAUSING PERSONAL INJURY OR DEATH TO THE SHOOTER OR THOSE IN THE IMMEDIATE VICINITY.

- A firearm and ammunition are a system and must work together. There are different types of ammunition for different types of firearms. Your firearm has been designed for ammunition of a specific type and a specific gauge or caliber. It is important to select the proper ammunition for your firearm.
- Different combinations of bullet velocity, bullet weight and firearm weight can have major impact on felt recoil; high felt recoil can be uncomfortable to some shooters.

For example:

- Firearm Weight: lower firearm weight increases felt recoil.
- Bullet Weight: higher bullet weight increases felt recoil.
- Bullet Velocity: higher bullet velocity increases felt recoil.

To acclimate yourself to higher levels of felt recoil, consider the following:

- Use a firm two-hand hold on the grip when firing.
- Always start your shooting experience with the lowest bullet velocity and lowest bullet weight available for your firearm.
- Ask your firearm dealer to suggest the lowest power, lowest velocity, lightest bullet weight for your firearm.



WARNING: NEVER USE AMMUNITION OF THE INCORRECT GAUGE OR CALIBER. USING AMMUNITION OF THE INCORRECT GAUGE OR CALIBER MAY CAUSE DAMAGE TO YOUR FIREARM AND POSSIBLE SERIOUS INJURY TO YOU AND TO OTHERS.

AMMUNITION CONTINUED



WARNING: NEVER USE CARTRIDGES OTHER THAN THOSE DESIGNATED BY THE MARKING ON THE FIREARM. DOING SO CAN RESULT IN DANGEROUSLY HIGH PRESSURES THAT MAY DAMAGE THE FIREARM AND POSSIBLY CAUSE SERIOUS INJURY TO YOURSELF AND OTHERS.



WARNING: DEATH, SERIOUS INJURY AND PROPERTY DAMAGE CAN RESULT FROM THE USE OF INCORRECT AMMUNITION OR BORE OBSTRUCTIONS. NEVER USE RELOADED AMMUNITION THAT HAS NOT BEEN SUBJECTED TO INTERNAL BALLISTIC PRESSURE TESTING. SEE THE FIRST WARNING ON PAGE 10 FOR DETAILS.

- “Plus-P” (+P) ammunition generates pressures in excess of the pressures associated with standard ammunition. Such pressures may affect the wear characteristics and may result in the need for more frequent service.
- “Plus-P-Plus” (+P+) ammunition must not be used in Smith & Wesson firearms. This marking on the ammunition designates that it exceeds established industry standards, but the designation does not represent defined pressure limits and therefore such ammunition may vary significantly as to the pressures generated and could be DANGEROUS.

Marking on Firearm	Ammunition Type		
	Standard	+P	+P+
380 AUTO	OK	NO	NO
9mm	OK	OK	NO
9x21mm	OK	NO	NO
38 Super	OK	OK	NO
357 SIG	OK	NO	NO
40 S&W	OK	NO	NO
45 AUTO	OK	OK	NO

- Some brands of ammunition may cause difficulty in extracting spent cartridge cases from the chamber. If this situation occurs, thoroughly clean the chamber with solvent. If this condition persists, we recommend changing to another brand of ammunition.

MODEL AND FEATURES IDENTIFICATION

MODEL NAME



FIGURE 2

SERIAL NUMBER

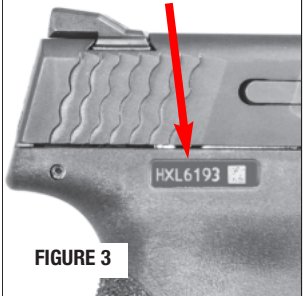

FIGURE 3

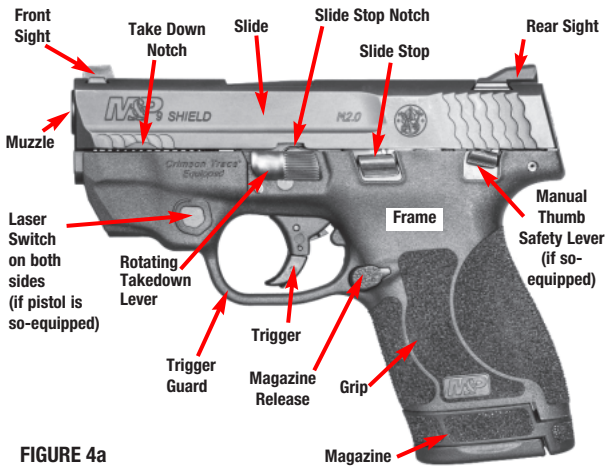

FIGURE 4a

INTEGRAL CRIMSON TRACE® LASER DETAILS



FIGURE 4b

On Those Models
So-Equipped

MODEL AND FEATURES IDENTIFICATION CONTINUED

Front sight with fiber optic

Slide cutout that accepts SHIELD Mini Optical Sight shown here with cover in place



On Those Models So-Equipped

FIGURE 4c

Slide cutout that accepts SHIELD Mini Optical Sight shown here with cover removed

Rear sight with fiber optic



On Those Models So-Equipped

FIGURE 4d

Ported slide and barrel

SHIELD Mini Optical Sight mounted in slide cutout



On Those Models So-Equipped

FIGURE 4e



WARNING: YOU MUST DETERMINE WHICH FEATURES ARE PRESENT ON YOUR SPECIFIC SMITH & WESSON FIREARM AND HOW THOSE FEATURES AFFECT OPERATION OR HANDLING. VARIOUS MODELS OF THE M&P SHIELD PISTOL ARE FITTED WITH DISTINCT FEATURES, WHICH MAY INCLUDE: A MANUAL THUMB SAFETY, A MAGAZINE SAFETY, A LASER SIGHT, A PORTED BARREL AND SLIDE, ONE OF SEVERAL LOADED CHAMBER INDICATORS AND AN OPTICAL SIGHT. SEE THE SECTION(S) OF THIS MANUAL THAT DETAIL EACH OF THESE FEATURES.

INSPECTING YOUR PISTOL



WARNING: ALWAYS ENSURE THAT THE FIREARM IS UNLOADED BEFORE INSPECTING, DISASSEMBLING, ASSEMBLING OR CLEANING AND ALWAYS KEEP THE MUZZLE POINTED IN A SAFE DIRECTION.

- Inspect your pistol by first checking for yourself to ensure that it is unloaded. To do this, grasp the pistol with your finger off the trigger and outside the trigger guard, point the muzzle in a safe direction, depress the magazine release and remove the magazine (FIGURE 5).



- Point the muzzle in a safe direction, grasp the serrated sides of the slide from the rear with the thumb and fingers as shown (FIGURE 6), and briskly draw the slide fully rearward in order to extract any cartridge from the chamber and clear it from the pistol. Do not obstruct the ejection port because doing so can interfere with ejection of a cartridge.



- Lock the slide in the open position by allowing the slide to move slightly forward from the rearmost position while pressing upward on the slide stop (FIGURE 7).



- Check the barrel chamber to verify it is unloaded and check the bore visually for any obstructions (FIGURE 8).
- Before using your firearm for the first time, it should be cleaned. See the cleaning section of this manual for details.



INSPECTING YOUR PISTOL CONTINUED

- Check the manual thumb safety lever (if your pistol is so-equipped) to verify that it is in the SAFE position (FIGURES 9 and 10).
- Examine the breech face (FIGURE 11a) to ensure that the firing pin is not protruding (FIGURE 11b).

WARNING: VERIFY THAT THE FIRING PIN IS NOT PROTRUDING FROM THE BREECH FACE. IF THE FIRING PIN IS PROTRUDING, MAKE SURE THE FIREARM IS POINTED IN A SAFE DIRECTION, UNLOAD THE FIREARM AND HAVE IT INSPECTED AND TEST FIRED BY A GUNSMITH QUALIFIED TO PERFORM SERVICE ON SMITH & WESSON® FIREARMS.

On Those Models So-Equipped

Manual thumb safety lever shown in the SAFE position



FIGURE 9

On Those Models So-Equipped

Manual thumb safety lever shown in the FIRE position



FIGURE 10

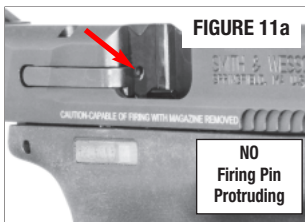

FIGURE 11a

NO
Firing Pin
Protruding



FIGURE 11b

Firing Pin
Protruding

- You must follow this procedure every time a firearm leaves your hand, is cleaned, handed to you or another person, transported or stored.
- Unload the magazine by holding it with the bullet end of the cartridge pointing away from you and others and pressing each cartridge forward and out of the magazine (FIGURE 12).

WARNING: NEVER RELY ON MECHANICAL FEATURES ALONE. ONLY YOUR SAFE GUN HANDLING WILL ENSURE THE SAFE USE OF YOUR FIREARM. THIS IS YOUR RESPONSIBILITY.



FIGURE 12

LOADED CHAMBER INDICATOR



WARNING: NEVER RELY UPON THE LOADED CHAMBER INDICATOR ALONE TO VERIFY THE PRESENCE OR ABSENCE OF A ROUND IN THE CHAMBER. THE SUREST METHOD TO DETERMINE THE PRESENCE OR ABSENCE OF A ROUND IN THE CHAMBER IS TO VISUALLY CHECK THE CHAMBER OF YOUR FIREARM BY REMOVING THE MAGAZINE AND PULLING AND LOCKING THE SLIDE IN THE OPEN POSITION.



WARNING: ALWAYS TREAT EVERY FIREARM AS IF IT IS LOADED AND WOULD FIRE IF THE TRIGGER IS PULLED. A LOADED CHAMBER INDICATOR MAY HELP DETERMINE WHETHER THE CHAMBER IS LOADED OR UNLOADED. THE AMOUNT OF LIGHT, CLEANLINESS OF THE PISTOL, COLOR OF THE AMMUNITION AND OTHER FACTORS MAY LIMIT THE EFFECTIVENESS OF THE LOADED CHAMBER INDICATOR.

- All M&P SHIELD® pistols come with a loaded chamber indicator, there are two types:

- Type 1: This indicator can be observed by looking at the top of the slide/ejection port, (FIGURE 13a) noting an opening at the rear of the barrel hood. By looking into this opening, you can observe whether or not a round is in the firearm's chamber. If a round is in the chamber, you should be able to see the actual cartridge rim through this opening.



FIGURE 13a

- Type 2: Some M&P SHIELD® pistols are equipped with a tactile loaded chamber indicator. This indicator is present on the top of the slide. When the chamber is empty, the loaded chamber indicator will be flush with the top of the slide. When the chamber is loaded, the front of the loaded chamber indicator will protrude from the top of the slide where it can be felt above the slide's surface (FIGURE 13b).





FIGURE 13b

MANUAL THUMB SAFETY LEVER

For Those Models So-Equipped

- Your M&P SHIELD® pistol may be equipped with a manual thumb safety lever.

 **WARNING: NEVER RELY ON MECHANICAL FEATURES ALONE. ONLY YOUR SAFE GUN HANDLING WILL ENSURE THE SAFE USE OF YOUR FIREARM. THIS IS YOUR RESPONSIBILITY.**

 **WARNING: IT IS YOUR RESPONSIBILITY TO CONTINUOUSLY EXAMINE YOUR PERSONAL SITUATION TO PROVIDE A SUFFICIENT LEVEL OF SAFETY.**

- This feature prevents the trigger from moving rearward when the manual thumb safety lever is in the “SAFE” position.

- Push the manual thumb safety lever fully upward to put it in “SAFE” position (FIGURE 14).

- Lower the manual thumb safety lever fully to put it in “FIRE” position allowing the pistol to be fired when the trigger is pulled (FIGURE 15).

- The slide can still be opened and closed regardless of the position of the manual thumb safety lever.

- The magazine can be removed and installed in the pistol regardless of the position of the manual thumb safety lever.

- The pistol can be loaded and unloaded regardless of the position of the manual thumb safety lever.



MAGAZINE SAFETY

For Those M&P SHIELD® Pistols So-Equipped

- Your pistol may be equipped with a magazine safety which prevents the pistol from firing when the magazine is removed from the pistol. Review FIGURES 16 and 17 below to determine if your pistol has this feature. Follow these instructions:

WARNING: YOUR M&P SHIELD® PISTOL MAY BE EQUIPPED WITH A MAGAZINE SAFETY. IN ORDER FOR THE MAGAZINE SAFETY TO OPERATE CORRECTLY, YOU MUST FULLY RELEASE THE TRIGGER AND REMOVE YOUR FINGER FROM WITHIN THE TRIGGER GUARD PRIOR TO THE MAGAZINE BEING REMOVED FROM THE PISTOL. FAILURE TO FULLY RELEASE THE TRIGGER COULD RESULT IN AN ACCIDENTAL DISCHARGE WHEN THE TRIGGER IS THEN PULLED THE REST OF THE WAY REARWARD - REGARDLESS OF THE PRESENCE OF A MAGAZINE IN THE PISTOL. "STAGING" THE TRIGGER (KEEPING TENSION ON THE TRIGGER) VIOLATES A BASIC RULE OF FIREARM SAFETY WHICH WARNS YOU TO KEEP YOUR FINGER OFF THE TRIGGER AND OUT OF THE TRIGGER GUARD UNTIL YOU HAVE MADE THE COMMITMENT TO FIRE. "STAGING" CREATES A SERIOUS RISK OF PERSONAL INJURY OR DEATH SINCE IT MAY LEAD TO AN UNINTENTIONAL DISCHARGE.

- If the pistol IS equipped with this feature, it will have a small lever mechanism that is visible in the magazine well (when the slide is open and the magazine is removed from the pistol) as shown (FIGURE 16).
- If the pistol IS NOT equipped with this feature, there will be no small lever present in the magazine well as shown in (FIGURE 17).
- The slide can still be opened and closed regardless of the presence of a magazine.

WARNING: IF YOUR M&P SHIELD® PISTOL IS NOT EQUIPPED WITH A MAGAZINE SAFETY, THE PISTOL CAN BE FIRED WHEN THE MAGAZINE IS REMOVED FROM THE PISTOL.

WARNING: NEVER RELY ON MECHANICAL FEATURES ALONE. ONLY YOUR SAFE GUN HANDLING WILL ENSURE THE SAFE USE OF YOUR FIREARM. THIS IS YOUR RESPONSIBILITY.



PORTED BARREL WARNINGS

For Those M&P SHIELD® Pistols So-Equipped



WARNING: ALWAYS KEEP YOUR FACE, HANDS, FINGERS, OR ANY OTHER BODY PARTS AWAY FROM THE BARREL/SLIDE PORTS DURING FIRING. ALWAYS ENSURE THAT BYSTANDERS ARE AWAY FROM THE BARREL/SLIDE PORTS DURING FIRING. PARTICLES AND HOT GAS WILL BE FORCED OUT OF THE BARREL AND SLIDE PORTS DURING NORMAL USE. FAILURE TO FOLLOW THIS WARNING WILL CAUSE SERIOUS PERSONAL INJURY AND MAY ALSO RESULT IN DAMAGE TO PROPERTY.

- NEVER CYCLE THE SLIDE WITH YOUR HAND OVER THE PORTS.
- DO NOT SHOOT A PORTED BARREL PISTOL “FROM THE HIP” OR FROM A RETENTION POSITION (WHEN THE FIREARM IS IN CLOSE PROXIMITY TO ANY PART OF THE BODY).
- USE CAUTION WHEN SHOOTING TO AVOID CONTACT WITH ANY OVERHEAD OBJECTS THAT COULD BE DAMAGED BY THE PARTICLES AND HOT GAS FORCED FROM THE BARREL/SLIDE PORTS DURING FIRING.



WARNING: NEVER INSTALL A PORTED BARREL IN A PISTOL WITH A NON-PORTED SLIDE. FAILURE TO FOLLOW THIS WARNING WILL CAUSE SERIOUS PERSONAL INJURY AND DAMAGE TO PROPERTY.

PREPARATION FOR FIRING



WARNING: YOU MUST DETERMINE WHICH FEATURES ARE PRESENT ON YOUR M&P SHIELD® PISTOL AND HOW THOSE FEATURES AFFECT OPERATION OR HANDLING. VARIOUS MODELS OF THE PISTOLS ARE FITTED WITH DISTINCT FEATURES, WHICH MAY INCLUDE: A MANUAL THUMB SAFETY SEE THE SECTION OF THIS MANUAL THAT DETAILS THIS FEATURE.



WARNING: THE FAILURE TO FOLLOW THESE FIREARM SAFETY REQUIREMENTS WILL CAUSE SERIOUS PERSONAL INJURY OR DEATH TO YOU OR OTHERS.

- **ALWAYS TREAT ALL FIREARMS AS IF THEY ARE LOADED.**
- **ALWAYS BE SURE THAT THE CHAMBER IS CLEAR OF A CARTRIDGE, THE MAGAZINE IS REMOVED OR UNLOADED, AND THAT THE FIREARM IS POINTING IN A SAFE DIRECTION.**
- **ALWAYS KEEP FINGERS AND OTHER PARTS OF YOUR BODY AWAY FROM THE MUZZLE AND AWAY FROM THE PISTOL SLIDE AND EJECTION PORT.**
- **ALWAYS WEAR ADEQUATE AND PROPER HEARING PROTECTION SPECIFIED FOR FIREARM USE** to prevent permanent damage to your hearing. Make sure others who are nearby are wearing hearing protection as well.
- **ALWAYS WEAR SAFETY GLASSES SPECIFIED FOR FIREARM USE**, whether indoors or out. Safety glasses should protect your eyes from the firing flash and particles associated with the discharge of ammunition. Failure to do so creates a risk of personal injury from particle or debris spitting or a ricochet.
- **ALWAYS BE ALERT AND ALWAYS FOLLOW THE SAFETY INSTRUCTIONS OF THE RANGE OFFICER.** Never shoot if you are tired, cold or impaired in any way.
- **ALWAYS BE AWARE OF OTHER PEOPLE** so that persons do not accidentally walk into the line of fire.
- **THE SHOOTER (AND ALL OTHERS IN THE SHOOTING AREA) MUST ALWAYS BE IN A POSITION THAT IS OUT OF THE LINE OF FIRE** and are not within an area where they may be struck by a ricochet or particles spitting from a firearm, or by ejected cases from some types of firearms.
- **NEVER SHOOT AT SURFACES THAT MAY CAUSE A RICOCHET.** Always select a place to shoot that has a safe backstop, is free from obstructions and has no surfaces which may cause a ricochet.
- **NEVER FIRE RANDOMLY INTO THE SKY.** Always select a place to shoot that has a safe backstop.
- **NEVER USE ALCOHOL OR DRUGS BEFORE OR WHILE SHOOTING OR HANDLING ANY FIREARM.**

LOADING



WARNING: ALWAYS KEEP THE MUZZLE POINTED IN A SAFE DIRECTION.

- Do not load the pistol until you have read and fully understand this manual.
- Do not load the pistol until you are ready to use it. Keep your finger off the trigger and outside the trigger guard until you are ready to fire.
- Never load your pistol until you are sure of your target, what is beyond it and are fully prepared to fire.

NOTE: After inserting a magazine, always test to make sure it is locked in place by applying some removal pressure to the exposed portion of the magazine butt plate.

- Smith & Wesson® has provided you with a magazine designed to operate in your specific model of pistol. While your magazine may be able to be inserted into another model pistol, it will only function properly in the specific model for which it was designed. Do not interchange magazines from one model pistol to another model pistol.
- Follow instructions in this manual and any other specific instructions which may be marked onto, or accompany, a magazine. Failure to use the particular type of Smith & Wesson® magazine specified for your model and caliber of pistol may result in a malfunction.
- Load the magazine by pressing a cartridge head (rear of cartridge) downward on the forward portion of the magazine follower (or downward on the case of the previously loaded cartridge) and sliding the cartridge fully under the lips of the magazine until the cartridge head is against the rear wall of the magazine (FIGURE 19). Repeat this procedure for the number of cartridges you wish to load, up to the magazine capacity. Do not attempt to load your magazine with more than the specified number of cartridges because doing so can cause a feeding failure.

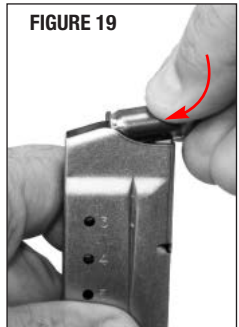

- Inspect your pistol as previously described in the “Inspecting Your Pistol” section. Hold the pistol in one hand with the muzzle pointing in a safe direction and with your finger off the trigger and outside the trigger guard. Insert the loaded magazine into the magazine well (opening) of the pistol until it is locked in place.

LOADING CONTINUED



WARNING: VERIFY THAT THE FIRING PIN IS NOT PROTRUDING FROM THE BREECH FACE. IF THE FIRING PIN IS PROTRUDING, MAKE SURE THE FIREARM IS POINTED IN A SAFE DIRECTION, UNLOAD THE FIREARM AND HAVE IT INSPECTED AND TEST FIRED BY A GUNSMITH QUALIFIED TO PERFORM SERVICE ON SMITH & WESSON FIREARMS.



WARNING: DO NOT USE EXCESSIVE UPWARD FORCE WHEN INSERTING A LOADED MAGAZINE INTO THE PISTOL. EXCESSIVE UPWARD FORCE COULD CAUSE THE SLIDE TO MOVE FORWARD, CHAMBERING A ROUND AND MAKING THE PISTOL READY TO FIRE.

- To make sure that the magazine is fully and securely inserted, apply some removal pressure to the exposed portion of the magazine floor plate.
- Pull the slide to the rear and release it, allowing it to carry fully forward. This strips a cartridge from the magazine and seats it in the chamber of the barrel.



WARNING: IF THE CARTRIDGE FAILS TO STRIP FROM THE MAGAZINE OR FULLY SEAT INTO THE CHAMBER, IMMEDIATELY STOP THE LOADING PROCESS. REMOVE THE MAGAZINE, LOCK THE SLIDE OPEN AND VERIFY THAT THE CHAMBER IS EMPTY. REFER TO THE “INSPECTING YOUR PISTOL” SECTION OF THIS MANUAL.



WARNING: ALWAYS LOAD A ROUND INTO THE CHAMBER BY FEEDING IT FROM THE MAGAZINE. FAILURE TO FOLLOW THIS WARNING CAN RESULT IN SEVERE INJURY OR DEATH TO YOU OR OTHERS. NEVER ATTEMPT TO LOAD THE PISTOL BY INSERTING A ROUND INTO THE OPEN EJECTION PORT.

CAUTION: The pistol can now be fired by pulling the trigger to the rear.

- If you wish to restore the magazine in your pistol to its full capacity, depress the magazine release and remove the magazine from the pistol. Remember that there is a round in the chamber; therefore, the weapon should be holstered or safely secured during this process without touching the trigger. Load one cartridge into the magazine to replace the one which was chambered when you allowed the slide to carry forward.
- Re-insert the loaded magazine into the magazine well of the pistol until it is locked in place. To make sure that the magazine is again fully and securely inserted, apply some removal pressure to the exposed portion of the magazine butt plate.

LOADING CONTINUED

- Your pistol and its magazine are now fully loaded and will fire when the trigger is pulled. Remember to keep your pistol pointed in a safe direction under all conditions and always keep your finger or any other object off the trigger and outside the trigger guard until you have made the commitment to fire the handgun. Never leave a loaded firearm out of your direct control.

FIRING



WARNING: ALWAYS KEEP THE MUZZLE POINTED IN A SAFE DIRECTION.



WARNING: UPON FIRING THE PISTOL OR RELEASING THE SLIDE FROM THE SLIDE STOP, THE SLIDE MOVES REARWARD OR FORWARD WITH SIGNIFICANT FORCE AND SPEED. TO AVOID INJURY, BE SURE NO PART OF YOUR BODY IS IN THE PATH OF THE SLIDE'S TRAVEL.



WARNING: WEAR EYE AND HEARING PROTECTION SPECIFIED FOR FIREARM USE EVERY TIME YOU DISCHARGE YOUR FIREARM. MAKE SURE OTHERS IN THE VICINITY OF WHERE YOU WILL BE SHOOTING DO SO AS WELL.



WARNING: IF YOUR PISTOL IS EQUIPPED WITH A MAGAZINE SAFETY, THE PISTOL WILL NOT FIRE WITH THE MAGAZINE REMOVED. YOU MUST FULLY RELEASE THE TRIGGER AND REMOVE YOUR FINGER FROM WITHIN THE TRIGGER GUARD WHEN THE MAGAZINE IS REMOVED FROM THE PISTOL. FAILURE TO FULLY RELEASE THE TRIGGER COULD RESULT IN AN ACCIDENTAL DISCHARGE WHEN THE TRIGGER IS THEN PULLED THE REST OF THE WAY REARWARD REGARDLESS OF THE PRESENCE OF A MAGAZINE IN THE PISTOL. "STAGING" THE TRIGGER (KEEPING TENSION ON THE TRIGGER) VIOLATES A BASIC RULE OF FIREARM SAFETY WHICH WARNS YOU TO KEEP YOUR FINGER OUT OF THE TRIGGER GUARD UNTIL YOU HAVE MADE THE COMMITMENT TO FIRE. "STAGING" CREATES A SERIOUS RISK OF PERSONAL INJURY OR DEATH SINCE IT MAY LEAD TO AN UNINTENTIONAL DISCHARGE.

FIRING CONTINUED

- It has come to our attention that some users of Smith & Wesson handguns may stage the trigger in anticipation of firing a shot. Staging is the act of pulling the trigger rearward toward – stopping just short of – the point where the handgun fires. Such manipulation of the trigger can reduce the user’s control of the handgun and can result in an unintentional discharge. Furthermore if the user decides not to fire, release of the trigger from a position close to the firing point in the staging process could result in an unintentional discharge.
- Keep the muzzle pointed in a safe direction and your finger outside the trigger guard until you are ready to fire. Each shot will be fired in the striker fire action mode. While holding the grip firmly, pull the trigger fully to the rear. As the trigger is drawn fully to the rear, the striker assembly is released, striking the cartridge primer and firing the round. Upon firing, the slide moves rearward thereby extracting and ejecting the spent cartridge case. The slide then returns forward feeding the next cartridge from the magazine into the barrel chamber.
- After firing you must allow the trigger to move fully forward to reset before you can fire another shot. Failure to do so will prevent the lockwork from fully cycling and will prevent your being able to fire the next shot. Keep your finger off the trigger and outside the trigger guard until you are ready to fire again. This sequence can be repeated until the last round has been fired, at which time the magazine follower exerts upward pressure on the slide stop causing it to engage the slide and to hold it in the “open” position.

CLEARING MISFIRES



WARNING: IF YOUR HANDGUN GIVES ANY INDICATION THAT IT IS NOT PERFORMING PROPERLY OR THE OPERATION OF YOUR HANDGUN HAS CHANGED “THE WAY IT FEELS OR SOUNDS”, STOP FIRING. MAKE SURE THE FIREARM IS POINTED IN A SAFE DIRECTION, UNLOAD THE FIREARM AND HAVE IT INSPECTED AND TEST-FIRED BY A GUNSMITH QUALIFIED TO PERFORM SERVICE ON SMITH & WESSON FIREARMS.

- If a cartridge fails to fire, wait ten seconds while keeping the muzzle pointed in a safe direction.
- Keep your finger off the trigger and out of the trigger guard.

- Depress the magazine catch and remove the magazine (FIGURE 20).



FIGURE 20

- Grasp the serrated sides of the slide from the rear and briskly pull the slide fully rearward to eject the mis-fired round (FIGURE 21). Do not obstruct the ejection port, and do not attempt to catch the round by placing your hand over the ejection port. Also, remember that any time you release the slide while a magazine containing cartridges is in the pistol, you will have reloaded the chamber.

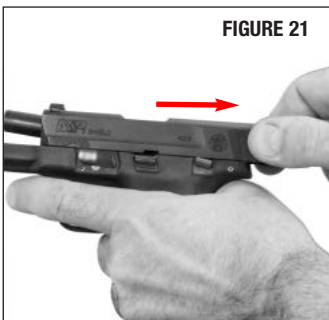

FIGURE 21

- In order to lock the slide in the open position, allow the slide to move slightly forward from the rearmost position while pressing upward on the slide stop (FIGURE 22). You are now able to safely check the barrel chamber and bore visually for any obstructions. You must be certain there are no cartridges in the chamber or obstructions in the barrel.



FIGURE 22

UNLOADING



WARNING: ALWAYS KEEP YOUR PISTOL POINTED IN A SAFE DIRECTION. ALWAYS KEEP YOUR FINGER OFF THE TRIGGER AND OUTSIDE THE TRIGGER GUARD WHEN UNLOADING.

- Point the muzzle in a safe direction. Make sure your finger is off the trigger and out of the trigger guard. Depress the magazine release and remove the magazine (FIGURE 23).

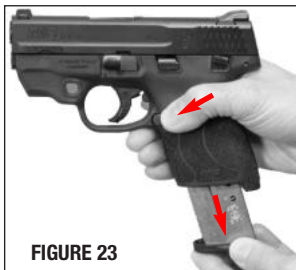

FIGURE 23

- Keep the muzzle still pointed in a safe direction, and keep your finger off the trigger and outside the trigger guard, grasp the serrated sides of the slide from the rear with the thumb and fingers, (FIGURE 24) and briskly draw the slide fully rearward in order to extract any cartridge from the barrel chamber and clear it from the pistol.



FIGURE 24

- Lock the slide in the open position by allowing the slide to move slightly forward from the rearmost position while pressing upward on the slide stop (FIGURE 25).



FIGURE 25

- Do not obstruct the ejection port when pulling the slide to the rear because doing so can interfere with ejection of a cartridge.



FIGURE 26

- Look into the chamber and down through the magazine well. Verify that no ammunition remains in the pistol (FIGURE 26).



FIGURE 27

- Unload the magazine by holding it with the bullet end of the cartridge pointing away from you and pressing each cartridge forward and out of the magazine (FIGURE 27).

FIELD STRIPPING / DISASSEMBLY



WARNING: ALWAYS KEEP THE MUZZLE POINTED IN A SAFE DIRECTION.



WARNING: ALWAYS ENSURE THAT THE FIREARM IS UNLOADED BEFORE INSPECTING, DISASSEMBLING OR ASSEMBLING.



WARNING: ALWAYS FOLLOW THE FIELD STRIPPING INSTRUCTIONS EXACTLY. NEVER DO ANYTHING BEYOND WHAT YOU ARE SPECIFICALLY INSTRUCTED TO DO IN THIS MANUAL. NEVER ALTER OR MODIFY THE PARTS IN YOUR PISTOL.



WARNING: WEAR SAFETY GLASSES EVERY TIME YOU ASSEMBLE OR DISASSEMBLE YOUR FIREARM.

- Point the pistol in a safe direction. Make sure your finger is off the trigger and out of the trigger guard. Depress the magazine release, and remove the magazine (FIGURE 28).
- Starting with the slide in the closed position, remove a chambered round as follows: with the barrel still pointing in a safe direction, with your finger off the trigger and outside the trigger guard, grasp the serrated sides of the slide from the rear with the thumb and fingers (FIGURE 29) while holding the firearm in an upright position, briskly draw the slide fully rearward in order to extract any cartridge from the barrel chamber and clear it from the pistol.
- Pull the slide fully to the rear, press upward on the slide stop while letting the slide move slightly forward thereby locking the slide open (FIGURE 30).
- Make certain that the chamber is clear (FIGURE 31).



FIGURE 28



FIGURE 29



FIGURE 30



FIGURE 31

FIELD STRIPPING / DISASSEMBLY CONTINUED

- Use a small screwdriver (or a similar device) to gently push the yellow(ish) sear deactivation lever down (rotate forward) into the magazine well (FIGURES 32 and 33).

NOTE: The sear deactivation lever is the small yellow(ish) lever that is visible toward the rear of the pistol when the slide is locked open.

- Rotate the takedown lever 90 degrees clockwise (FIGURE 34).
- Pull the slide slightly rearward to disengage the slide stop and then remove the slide forward from the frame while being careful to retain the recoil spring and guide rod assembly (FIGURE 35).

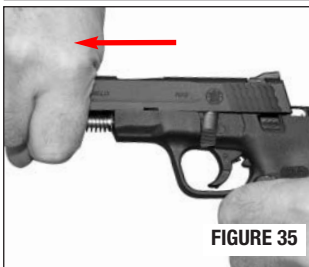
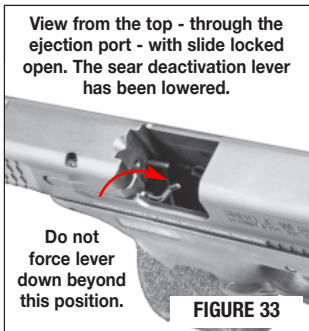
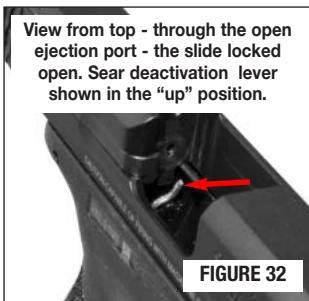

- Remove the recoil spring assembly from below the barrel (FIGURE 36). Compress the rear of the spring forward slightly and lift it up from the rear and out of the groove in the barrel lug. Lift the spring out of the slide and set it aside.



- Remove the barrel from the bottom of the slide (FIGURE 37) by grasping the barrel lug and lifting it up and back.



FIELD STRIPPING / DISASSEMBLY CONTINUED

- FIGURE 38 shows the separate parts that you will have after field stripping your pistol.

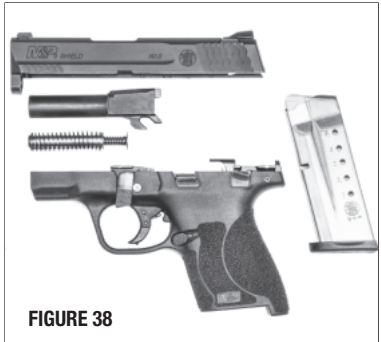

WARNING: DO NOT ALTER, MODIFY OR REPLACE ANY OF THE PARTS OF YOUR FIREARM UNLESS THIS WORK IS PERFORMED BY A QUALIFIED GUNSMITH USING GENUINE SMITH & WESSON PARTS. IF YOU DO OTHERWISE, IMPROPER FUNCTIONING MAY OCCUR AND SERIOUS INJURY MAY RESULT.

WARNING: NEVER DISASSEMBLE YOUR HANDGUN BEYOND THE FIELD STRIPPING PROCESS OUTLINED IN THIS MANUAL. NEVER MANIPULATE ANY INTERNAL COMPONENTS BEYOND WHAT YOU ARE SPECIFICALLY INSTRUCTED TO DO IN THIS MANUAL SINCE THIS MAY AFFECT THE RELIABILITY, FUNCTIONING AND SAFETY OF YOUR HANDGUN.

LUBRICATION

- There are seven (7) lubrication points where a single drop of high-quality firearm lubricant should be applied. This will ensure proper lubrication. Care should be taken not to over-lubricate. Excess lubricant can collect quantities of unburned powder and carbon residue, which could interfere with proper functioning of the pistol (FIGURES 39 and 40).

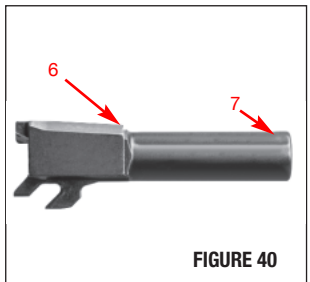
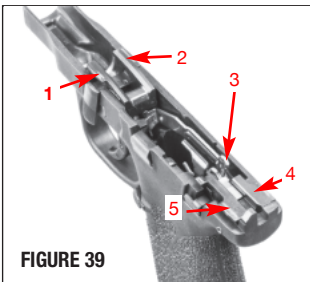

ASSEMBLY



WARNING: ALWAYS FOLLOW THE FIELD STRIPPING INSTRUCTIONS EXACTLY. NEVER DO ANYTHING BEYOND WHAT YOU ARE SPECIFICALLY INSTRUCTED TO DO IN THIS MANUAL. NEVER ALTER OR MODIFY THE PARTS IN YOUR PISTOL.



WARNING: WEAR SAFETY GLASSES EVERY TIME YOU ASSEMBLE OR DISASSEMBLE YOUR FIREARM.

- With the bottom of the slide turned up, replace the barrel in the slide so the muzzle is flush with the end of the slide and the barrel lug is turned up away from the ejection port (FIGURE 41). Next, insert the recoil spring assembly into the slide (muzzle end) and tip the rear of the spring into the notch on the barrel lug (FIGURE 42). Make sure it is properly centered (FIGURES 43 through 46).

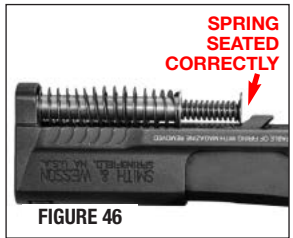
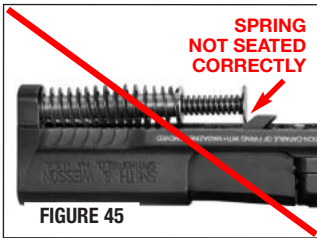
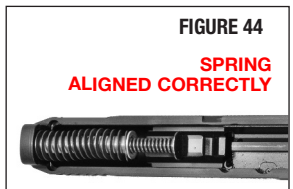
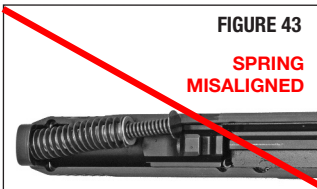
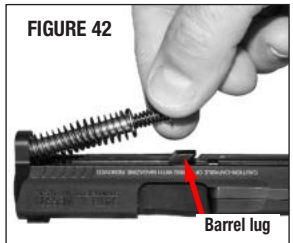
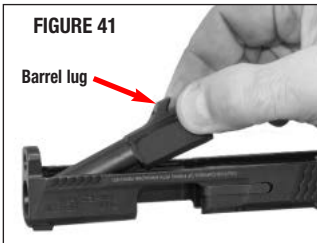

- Verify that the sear deactivation lever (yellow colored lever - visible when the slide is open or off the frame) is in the lowered position; it must be protruding into the magazine well as shown (FIGURE 47).

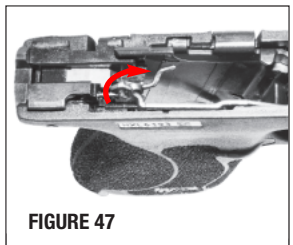

ASSEMBLY CONTINUED

- With recoil spring assembly in place and the takedown lever in the down position, place the rear of the slide onto the front frame rails (FIGURE 48).



- Move the slide rearward until it engages the rear frame rails (FIGURE 49). Once the rear frame rails are engaged, pull the slide fully rearward until it stops.

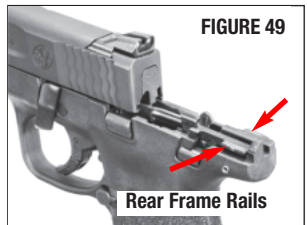

- With the slide held fully rearward, push the slide stop up to engage the slide stop notch. Let the slide move forward slightly as the slide stop is held up to allow the slide stop to engage the notch and hold the slide open (FIGURE 50).



- Rotate the takedown lever 90 degrees counter-clockwise so it is parallel with the frame (FIGURES 51 and 52).

- Pull the slide rearward to disengage the slide stop and then allow the slide to move fully forward to the closed position.



- Replace the empty magazine into the pistol - which returns the sear deactivation lever to normal operation mode.

- Check for proper functioning by drawing the slide fully rearward - at which point the slide stop should move up and hold the slide open.



SIGHT ADJUSTMENT



WARNING: ENSURE YOUR FIREARM IS UNLOADED BEFORE ADJUSTING YOUR SIGHTS. AT ALL TIMES FOLLOW THE BASIC FIREARMS SAFETY RULES IN THE SECTION ENTITLED “YOUR SAFETY RESPONSIBILITIES”.

- The rear sight is not adjustable. No attempt should be made to move the rear sight on this model. Removal of the rear sight and its replacement should only be performed by a gunsmith who is familiar with Smith & Wesson products.
- The front sight (FIGURE 53) can be drifted left or right to adjust windage. Move the front sight in the opposite direction that you wish the group to move on target. For example, if the group should move to the right, move the front sight to the left (as viewed from the rear). Use a brass drift or punch to prevent marring the sight when moving it.



FIGURE 53

NOTE: For models with integral Crimson Trace® laser, see the section of this manual that details the use and care of the laser sight.

NOTE: For models with SHIELD Mini Optical sight, see the section of this manual that details the use and care of the optical sight.

MAGAZINE - M&P®45 SHIELD™



WARNING: WEAR SAFETY GLASSES EVERY TIME YOU ASSEMBLE OR DISASSEMBLE YOUR MAGAZINE.



WARNING: MAGAZINE SPRING IS UNDER PRESSURE. CONTROL THE SPRING AND FOLLOWER SO THAT THEY DO NOT FLY OUT AND CAUSE INJURY.

- The M&P®45 SHIELD™ pistol ships with 2 magazines (FIGURES 54 through 56). The magazine with the flush fit floor plate holds six rounds. The magazine with the extended floor plate will hold 7 rounds of ammunition.

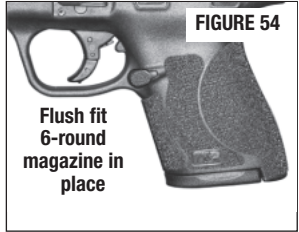

**Flush fit
6-round
magazine in
place**



**Extended
7-round
magazine in
place**

- The magazine tubes are the same for both. FIGURE 57 shows how a fully loaded magazine will appear for each.

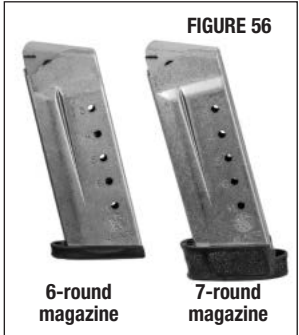

FIGURE 56

**6-round
magazine**

**7-round
magazine**

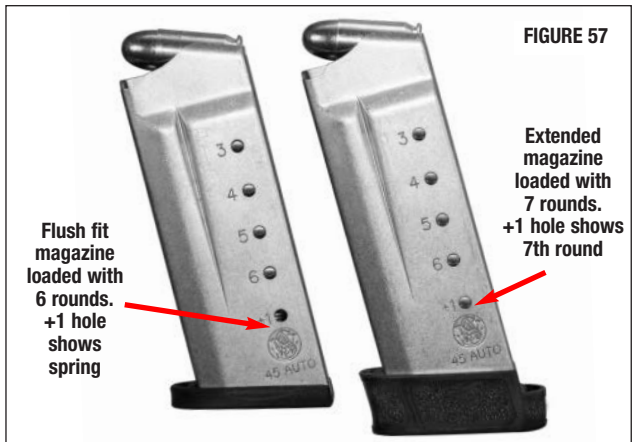

FIGURE 57

**Flush fit
magazine
loaded with
6 rounds.
+1 hole
shows
spring**

**Extended
magazine
loaded with
7 rounds.
+1 hole shows
7th round**

MAGAZINE DISASSEMBLY

1. Using a small tool (like a screwdriver), depress floor plate catch through the hole in the floor plate (FIGURE 58) and move the floor plate slightly forward. The seven round magazine floor plate catch needs to be depressed until it is bottomed out (and the guides are visible - FIGURE 59) before sliding floor plate forward
2. While holding floor plate catch in the tube (FIGURE 60) against spring pressure, slide floor plate forward off of the tube.
3. Remove floor plate catch, spring and follower out through bottom of tube.
4. Turn the tube right side up and remove spring and follower through bottom of the tube.

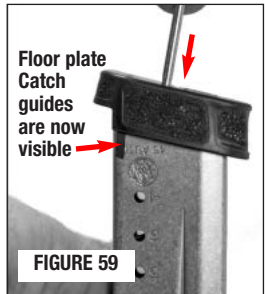
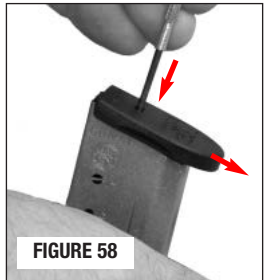

MAGAZINE ASSEMBLY

1. Install magazine spring and follower and floor plate catch front to back into the tube in exactly the same orientation as they were in when they were first removed during disassembly.
2. Holding floor plate catch in the tube, slide the floor plate onto the tube's base so that the projection of the floor plate catch engages the floor plate. Verify that the floor plate is locked in place by exerting some pressure on the floor plate - as if trying to slide it off the tube.

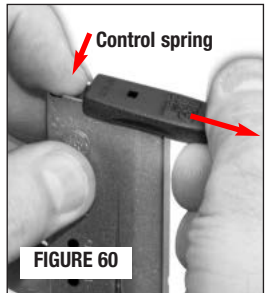

MAGAZINE - M&P®45 SHIELD™ CONTINUED

- FIGURES 61 and 62 show the M&P®45 SHIELD™ magazines disassembled for cleaning.

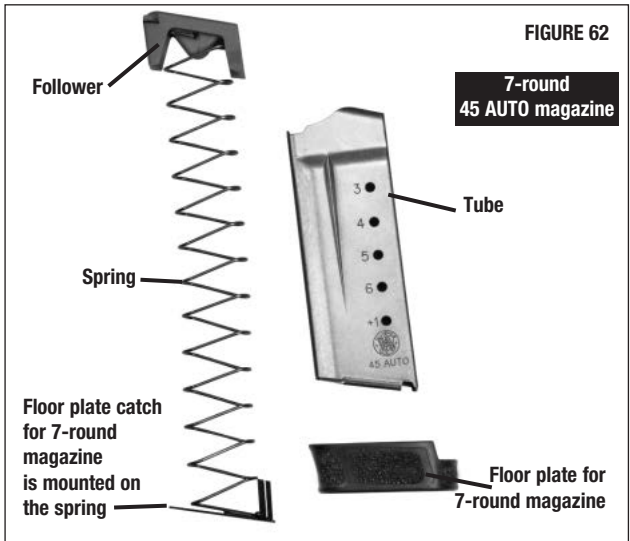
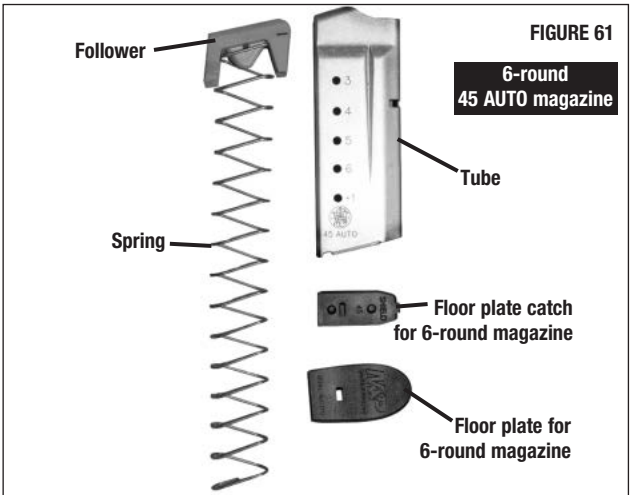

- The 7 round magazine (with the extended floor plate FIGURE 63 above) should have the floor plate catch oriented as shown (FIGURE 59) when re-assembling.

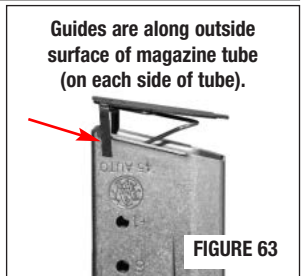

MAGAZINE - M&P®9 or 40 SHIELD™



WARNING: WEAR SAFETY GLASSES EVERY TIME YOU ASSEMBLE OR DISASSEMBLE YOUR MAGAZINE.



WARNING: MAGAZINE SPRING IS UNDER PRESSURE. CONTROL THE SPRING AND FOLLOWER SO THAT THEY DO NOT FLY OUT AND CAUSE INJURY.

MAGAZINE DISASSEMBLY

1. Using a small diameter tool, depress floor plate catch through the hole in the floor plate (FIGURE 64).
2. Slide floor plate forward off of the tube while holding floor plate catch in the tube (FIGURE 65) against spring pressure.
3. Remove floor plate catch and spring and follower out through bottom of tube.
4. Turn the tube right side up and remove spring and follower through bottom of the tube.

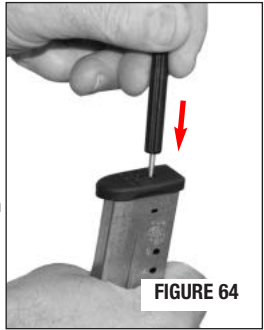

FIGURE 64

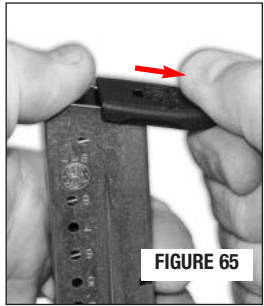

FIGURE 65

MAGAZINE ASSEMBLY

1. Install magazine spring and follower and floor plate catch front to back into the tube in exactly the same orientation as they were in when they were first removed during disassembly (FIGURE 66).
2. Holding floor plate catch in the tube, slide the floor plate onto the tube's base so that the projection of the floor plate catch engages the floor plate. Verify that the floor plate is locked in place by exerting some pressure on the floor plate - as if trying to slide it off the tube.

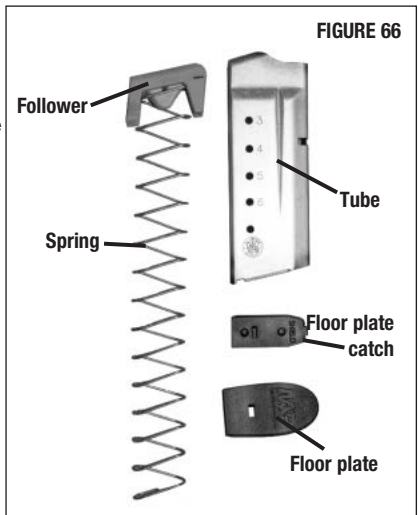



FIGURE 66

CLEANING AND MAINTENANCE

 **WARNING: ENSURE THAT YOUR FIREARM IS UNLOADED BEFORE BEGINNING TO CLEAN IT. (SEE “INSPECTING YOUR FIREARM” SECTION). ALWAYS FOLLOW THE RULES OF SAFE GUN HANDLING.**

 **WARNING: WEAR SAFETY GLASSES EVERY TIME YOU ASSEMBLE OR DISASSEMBLE YOUR FIREARM AND ATTEMPT CLEANING OR MAINTENANCE.**

- Before using your firearm for the first time, it should be cleaned.
- Your firearm was treated at the factory with either a preservative or oil to protect it against corrosion during shipping and storage.
- Preservative and oil should be wiped from the bore, chamber and exposed areas using a clean swab or patch before using the firearm.

CAUTION: Never disassemble your firearm beyond the instructions in the Field Stripping and Inspection sections of this manual.

- Purchase cleaning supplies from your firearms dealer that are specifically designated for your type and caliber of firearm. Many suppliers offer these in kit form for your convenience.
- Follow the instructions provided with your cleaning supplies.

NOTE: A basic firearm cleaning kit should include: a brass bore brush and a cleaning jag of appropriate size for the bore being cleaned, high-quality gun cleaning solvent and gun oil/lubricant, cotton cleaning patches and a cleaning rod that is long enough to push the brush and jag completely through the barrel.

- Remove excessive firing residue from the bore and chamber using a properly fitted brass brush dipped in gun cleaning solvent. Finish the bore cleaning process by running a dry cotton cloth patch through the bore to remove residue and solvent.
- Clean the exterior of the firearm using a non-abrasive cleaning cloth.
- After cleaning, lightly coat the metal parts, internal and external with a high quality gun oil. Refer to the “Lubrication” section in this manual for instructions on lubricating the firearm.
- Whenever your firearm has been exposed to sand, dust, extreme humidity, water or other adverse conditions, it must be cleaned and lubricated.

CLEANING AND MAINTENANCE CONTINUED



WARNING: ALWAYS HAVE ADEQUATE VENTILATION. CLEANING FIREARMS IN POORLY VENTILATED AREAS, DISCHARGING FIREARMS, OR HANDLING AMMUNITION MAY RESULT IN EXPOSURE TO LEAD AND OTHER SUBSTANCES KNOWN TO CAUSE BIRTH DEFECTS, REPRODUCTIVE HARM, AND OTHER SERIOUS PHYSICAL INJURY. WASH HANDS THOROUGHLY AFTER EXPOSURE.

CAUTION: Always follow the instructions provided with your gun cleaner and gun lubricant.

CAUTION: Some cleaners can cause damage to your firearms. You should avoid prolonged solvent immersion and avoid any ultrasonic cleaning of your firearm. Choice of solvent should be restricted to those products specifically developed for firearms maintenance. Damage to a firearm's finish may occur if these cautions are ignored. Ammoniated solvents or other strong alkaline solvents, should not be used on any Smith & Wesson® firearm.

- Cleaning is essential to ensure the proper functioning of your firearm.
- Your firearm is a precision instrument. To ensure reliable function it is necessary to follow a routine maintenance procedure. After firing your firearm, be sure to unload it following the procedure outlined in the section entitled "Inspecting Your Firearm" before performing any cleaning or maintenance procedure.
- Remove any gun cleaning solution, oil and fingerprints from the outside surfaces of the firearm. (Finger moisture, if left, could start a corrosion process.)



WARNING: NEVER MANIPULATE, ADJUST OR CHANGE ANY OF THE INTERNAL COMPONENTS OF YOUR FIREARM UNLESS SPECIFICALLY DIRECTED TO DO SO IN THIS MANUAL. IMPROPER MANIPULATION OF ANY INTERNAL COMPONENT MAY AFFECT THE SAFETY AND RELIABILITY OF YOUR FIREARM AND MAY CAUSE SERIOUS INJURY OR DEATH.



WARNING: ANY MAINTENANCE OR SERVICE NOT SPECIFIED IN THIS MANUAL MUST BE PERFORMED BY A QUALIFIED GUNSMITH USING GENUINE SMITH & WESSON® PARTS. IF YOU DO OTHERWISE, IMPROPER FUNCTIONING OF YOUR FIREARM MAY OCCUR AND SERIOUS INJURY OR DEATH MAY RESULT.

CLEANING AND MAINTENANCE CONTINUED

- If your firearm will be used in a cold climate, be sure to use an oil of an appropriate weight so that it will not congeal in cold temperatures, causing the interaction of important parts to be slowed or halted.

MAINTENANCE BEFORE STORAGE

- When storing, do not encase your firearm in anything that will attract or hold moisture, for example, leather or heavy cloth. Also, do not store guns with a plug inserted in the barrel for this can be a contributing factor to moisture accumulation. If your firearm is to be stored for an extended period, the bore, chambers and internal working mechanism should be oiled with a high quality lubricating oil or preservative intended for firearms. The external working mechanisms and barrel should be coated with an anti-rust oil. Before using your firearm again, be sure to clean it. Every time you clean your firearm, check it for signs of wear. If excessive wear is noted, do not use the firearm. Return it to Smith & Wesson® for service or have it checked by a qualified gunsmith.

LIMITED WARRANTY

For Owners Within The United States.

This warranty is granted by Smith & Wesson® Inc. This warranty is effective from the date of purchase and applies to the original owner of any firearm. With respect to such firearms, this warranty supersedes any and all other warranties.

Smith & Wesson® firearms are warranted to be free from defects in material and workmanship. Any such defects of which Smith & Wesson® receives written notice within one year from the date of purchase by the original owner, will be remedied by Smith & Wesson® without charge within a reasonable time after such notification and delivery of the firearm as provided below.

In the event of an emergency (repairs needed by law enforcement, an upcoming match or hunting trip), call 1-800-331-0852, ext. 4125 and ask for 911 Priority Repair Service. This allows you to speak with a Smith & Wesson® representative. Immediately upon receipt, your firearm will be assigned to a gunsmith. After the work is completed, we will return your Smith & Wesson® firearm via overnight delivery.

To submit a warranty claim please see the "Contact and Shipping Information" below for details. In addition to the requested information, please include a copy of the bill of sale in the owner's name, or a copy of the ATF Form 4473 indicating date of purchase. It is always important that the owner comply with all applicable federal, state and local laws and regulations.

Warranty claims should state the model and serial number of the firearm concerned and the description of the difficulty experienced. It is recommended that shipments be insured by the owner, since Smith & Wesson® will accept no responsibility for loss or damage in transit. Transportation and insurance charges for return to owner will be paid by Smith & Wesson® if the claim is covered by the warranty.

UNDER NO CIRCUMSTANCES SHALL SMITH&WESSON BE RESPONSIBLE FOR INCIDENTAL OR CONSEQUENTIAL DAMAGES WITH RESPECT TO ECONOMIC LOSS, INJURY, DEATH OR PROPERTY DAMAGE, WHETHER AS A RESULT OF BREACH OF THIS WARRANTY, NEGLIGENCE OR OTHERWISE.

Some states do not allow the exclusion or limitation of incidental or consequential damages, so the above limitation or exclusion may not apply to you.

LIMITED WARRANTY CONTINUED

Smith & Wesson® will not be responsible for:

- Defects or malfunctions resulting from careless handling, unauthorized adjustments or modifications made or attempted by anyone other than a qualified gunsmith following Smith & Wesson® authorized procedures, or failure to follow the disassembly instructions in the Smith & Wesson® manual.
- Use of defective or improper ammunition, corrosion, neglect, abuse, ordinary wear and tear, or unreasonable use.
- Criminal misuse, negligence or use under the influence of drugs or alcohol.

Smith & Wesson's Lifetime Service Policy begins after the warranty period has expired. Smith & Wesson® will repair, without charge, for the lifetime of the original owner, any Smith & Wesson® handgun purchased on or after February 1, 1989, and any M&P®15 series rifle, that is found to have a defect in material or workmanship. Eligibility for this Lifetime Service Policy requires returning the Product Registration Card within 30 days of purchase. The Lifetime Service Policy covers functional defects; it does not include the firearm's finish, grips, magazines or sights. The Lifetime Service Policy is in addition to and not an extension of the Smith & Wesson® Warranty.

This warranty gives you specific legal rights. You may also have other rights that vary from State to State.

NOTE: All liability is excluded in the event that the instructions in the Smith & Wesson® manual are not observed.

CONTACT AND SHIPPING INFORMATION

For Owners Within The United States

NOTE: A Return Merchandise Authorization (**RMA**) is the first step in the process of returning a product in order to receive a repair, replacement or refund. Please contact Smith & Wesson's Customer Service Dept. (via e-mail: qa@smith-wesson.com or by phone at 800-331-0852 ext. 4125) to obtain authorization to return your firearm so we can process it quickly and efficiently. The RMA number that is supplied by Smith & Wesson® must be displayed on the outside of the returned product's packaging; returns without an RMA number will be routed differently which will result in delayed processing.

The Return Merchandise Authorization (**RMA**) process allows Smith & Wesson® an opportunity to try to diagnose and correct a customer's concerns with the product (such as ammunition problems) before it is returned. Accordingly, please contact us before returning your Smith & Wesson firearm.

CONTACT CUSTOMER SERVICE

Tel: 800-331-0852 ext. 4125

E-mail: qa@smith-wesson.com

RETURNS - FOR SERVICE

ALL SMITH & WESSON FIREARMS

Smith & Wesson
2100 Roosevelt Avenue
Springfield, MA 01104

Should your Smith & Wesson® firearm require service, it should be returned to the Smith & Wesson® factory.

- Call or e-mail the Customer Service Dept. for authorization and shipping instructions.
- Ensure that the firearm is unloaded.
- **Do not attempt to ship a firearm via US Postal Service; only federally licensed dealers may ship a firearm by US Postal Service.**
- **DO NOT SHIP ANY AMMUNITION.**

CONTACT AND SHIPPING CONTINUED

- Enclose a letter which includes your full name and address (no P.O. Boxes, please), daytime telephone number, e-mail address, the serial number of the firearm, and details of the problem experienced (stating the brand and type of ammunition used when the problem occurred) or work desired.
- Record the serial number before shipping, in case you wish to check on the repair status of your firearm.
- Please remove all custom parts and accessories, such as stocks, special sights and scopes, or slings from your firearm before returning.
- Place the firearm in its original case or in a similarly secure container and pack it securely.
- The package must NOT bear any markings which indicate the identity of the contents.
- It is most important that you comply with federal, state, and local laws and regulations. The following guidelines are meant to help, but you must seek assistance from the appropriate authorities if necessary.
- If your firearm must be replaced, it may be necessary to ship the replacement to a dealer rather than directly to you. You will be requested to furnish a signed FFL (Federal Firearms License) from your dealer in such an instance.
- Warranty repair work will begin upon receipt and examination of the firearm. In the case of repairs or work not covered by the warranty, a quotation covering the cost of the work plus round trip transportation charges will be sent to you. Repairs or modification will be scheduled upon receipt of payment.
- A parts list can be obtained by contacting Smith & Wesson® Customer Service.



WARNING: YOU MAY PURCHASE ACCESSORIES FOR YOUR SMITH & WESSON® FIREARM. YOU MUST HAVE SOME OF THESE PARTS INSTALLED BY A GUNSMITH QUALIFIED TO PERFORM SERVICE ON SMITH & WESSON FIREARMS. YOU MUST NEVER ATTEMPT TO MODIFY YOUR FIREARM OR INSTALL REPLACEMENT PARTS IN YOUR FIREARM. ALWAYS USE A QUALIFIED SMITH & WESSON GUNSMITH EVEN IF THE REPAIR SEEMS SIMPLE.

APPENDIX “A” CRIMSON TRACE® LASER

OPERATOR MANUAL FOR CRIMSON TRACE® INTEGRATED LASER IN THE M&P SHIELD® M2.0™

LASER NUMBER AND COLOR: LX-380 (Red) or LX-382 (Green).



WARNING: ALWAYS KEEP YOUR FIREARM POINTED IN A SAFE DIRECTION. ALWAYS TREAT EVERY FIREARM AS IF IT IS LOADED AND WILL FIRE. DO NOT TAKE ANYONE’S WORD THAT THE FIREARM IS UNLOADED – ALWAYS CHECK FOR YOURSELF.



WARNING: ENSURE THAT YOUR FIREARM IS UNLOADED BEFORE ATTEMPTING ANY ADJUSTMENT, CLEANING OR MAINTENANCE TO THE CRIMSON TRACE® LASER. ALWAYS FOLLOW THE RULES OF SAFE GUN HANDLING.

CRIMSON TRACE® LASER OPERATION

- This appendix is intended for use by operators of the M&P SHIELD® M2.0™ Integrated Crimson Trace® laser. It provides a system description, operational procedures, and maintenance responsibilities. Complete familiarization with this manual prior to using the equipment will ensure safe operation and maximum effectiveness of the Crimson Trace® laser.

On/Pulse/Off Activation Buttons

(Activation buttons on both sides of frame perform the same function)

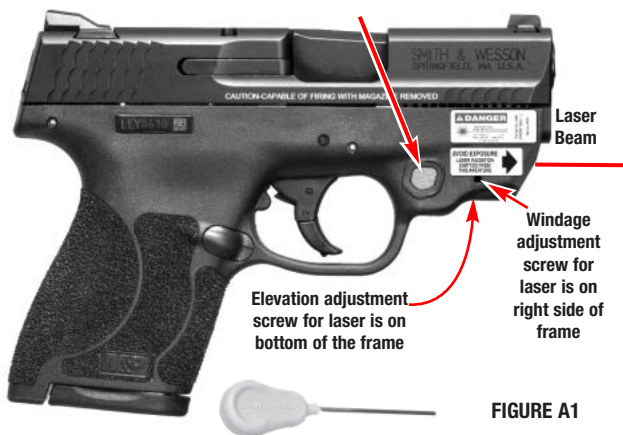

Tool provided. To remove/install and adjust laser.

CRIMSON TRACE® LASER OPERATION CONTINUED

MODEL NUMBER & EQUIPMENT NAME: LX-380 or LX-382
M&P SHIELD® M2.0™ Integrated Crimson Trace® Laser
MANUFACTURER: Crimson Trace Corporation
9780 SW Freeman Dr., Wilsonville, OR 97070 USA
Tel: (800) 442-2406 Fax: (503) 783-5334
crimsontrace.com

PURPOSE OF EQUIPMENT: The Crimson Trace® Laser is a FDA Class IIIa (IEC Class 3R) Laser Product that emits visible light for precise aiming of the M&P SHIELD® M2.0™ pistol.

The Crimson Trace® laser provides for active target acquisition in low light and close quarters situations and features ambidextrous laser controls, three operating modes, and a five minute auto-off timer.

CRIMSON TRACE® LASER BATTERIES



WARNING: DO NOT USE THE CRIMSON TRACE® LASER WITH A MIX OF OLD AND NEW BATTERIES, OR BATTERIES OF DIFFERENT BRANDS – RISK OF FIRE, EXPLOSION AND BURNS.

CAUTION: Do not store the Crimson Trace® laser with the battery/batteries installed for extended periods of time without testing periodically during such periods of non-use to ensure that it is functioning properly. When anticipating use of and reliance upon the Crimson Trace® laser, check beforehand to ensure it is in proper working order.

- **Battery Inspection:** The Crimson Trace® LX-380 laser is powered by two (2) #357 silver oxide batteries. The Crimson Trace® LX-382 laser is powered by one (1) CR 1/3N lithium battery. Before installation, inspect the batteries for any cracks, dents, leakage, or bulging. Never install a defective battery in the Crimson Trace® laser.

NOTE: Replacing batteries once a year is recommended. Any battery has the potential to leak harmful chemicals that can damage skin, clothing, or the inside of the Crimson Trace® laser. To avoid risk of injury, the following safety precautions apply when handling, storing, or disposing of batteries:

- Do not short circuit, puncture, incinerate, or disassemble.
- Do not attempt to recharge the battery/batteries.
- Prior to use, inspect all batteries for cracks, dents, leakage, or bulging. Never install a defective battery in the Crimson Trace® laser.

CRIMSON TRACE® LASER BATTERIES CONTINUED

- Performance of the batteries will vary depending on actual environmental conditions. Check beforehand to ensure that the laser is in proper working order.

NOTE: Dispose of all depleted batteries in accordance with applicable federal, state, and local environmental regulations.

CRIMSON TRACE® LASER SAFETY PRECAUTIONS



WARNING: VISIBLE LASER RADIATION EMITS FROM THE CRIMSON TRACE® LASER WHILE IN OPERATION – AVOID DIRECT EYE EXPOSURE.

- **DO NOT STARE INTO THE LASER BEAM.**
- **DO NOT LOOK INTO THE LASER BEAM THROUGH BINOCULARS OR TELESCOPES.**
- **DO NOT POINT THE LASER BEAM AT MIRROR-LIKE SURFACES.**
- **DO NOT SHINE THE LASER BEAM INTO ANOTHER INDIVIDUAL'S EYES OR INTO A PET'S EYES.**

CRIMSON TRACE® PRODUCT SPECIFICATIONS:

- LX-380 RED LASER: 5mW peak, 620–670nm, Class 3R laser
- LX-382 GREEN LASER: 5mW peak, 515–532nm, Class 3R laser
- BEAM INTENSITY: 5mW peak, Class 3R laser
- BEAM SIZE: 90% of Light Contained in Approx. 0.5" @ 50 Ft.
- BATTERIES LX-380: Two (2) #357 silver oxide batteries.
- BATTERY LX-382: One (1) CR 1/3N lithium 3V.
- ACTIVATION: Instant Activation - On/Pulse/Off activation-buttons with auto off at five minutes.
- WARRANTY: One-year full warranty.
- Crimson Trace® laser sights comply with 21 CFR 1040.10

Laser Battery Guidelines:

- Proper functioning of the Crimson Trace® laser is dependent upon fully charged batteries. Batteries typically provide laser illumination of four (4) hours for red lasers and two (2) hours for green lasers under normal conditions. If the laser becomes dim or fades, simply replace the batteries. Keep battery compartment free of dirt or other contaminants. Debris inside the battery compartment may affect laser operation and performance.



WARNING: DO NOT USE THE CRIMSON TRACE® LASER IN ENVIRONMENTS CONTAINING AN EXPLOSIVE ATMOSPHERE OR IN AREAS WHERE GASOLINE, PAINTS, SOLVENTS, OR OTHER FLAMMABLE LIQUIDS ARE STORED.

CRIMSON TRACE® LASER SAFETY PRECAUTIONS CONTINUED

- Before use, inspect all pieces of equipment for any damage such as cracks, loose parts, or other visible defects. If any damage or defects are noted:

CONTACT SMITH & WESSON CUSTOMER SERVICE

Tel: 800-331-0852 ext. 4125

E-mail: qa@smith-wesson.com

RETURNS FOR SERVICE -

FOR ISSUES INVOLVING THE LASER SIGHTING DEVICE:

**Smith & Wesson
Customer Service Department
2100 Roosevelt Avenue,
Springfield, Massachusetts 01104**

REMOVE / INSTALL CRIMSON TRACE® LASER



WARNING: ENSURE YOUR FIREARM IS UNLOADED BEFORE ADJUSTMENT OF THE CRIMSON TRACE® LASER. AT ALL TIMES FOLLOW THE BASIC FIREARMS SAFETY RULES IN THE SECTION ENTITLED "YOUR SAFETY RESPONSIBILITIES".

- The Crimson Trace® laser must be removed from the firearm for inspecting, cleaning or replacing batteries.
- Follow the instructions in the Field Stripping / Disassembly Section of this manual to remove the slide from the frame.

- Use the provided hex tool to turn the screw at the rear of the laser housing counterclockwise until the screw disengages from the frame of the M&P SHIELD® M2.0™ (FIGURE A2) - The screw remains captive in the laser housing and won't come out.

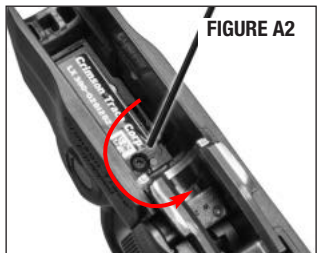

REMOVE / INSTALL CRIMSON TRACE® LASER CONTINUED

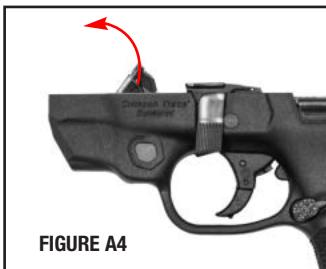
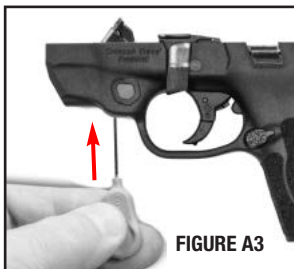

- Use the tool to push the laser housing (FIGURE A3) up out of its recess at the rear and tip it forward as shown (FIGURE A4). The hole closest to the trigger guard is the one to insert the tool into to gently push the laser unit up from.

- Pull the laser assembly up and out of its seating cavity (FIGURE A4).

LX-380 (red laser)

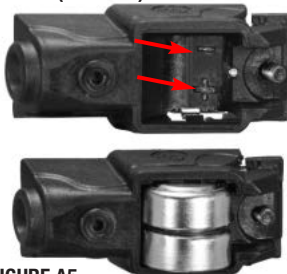

- In the LX-380 (red laser) Install two (2) #357 silver oxide batteries as shown (FIGURE A5). Proper battery orientation is clearly marked on the battery pocket of the Crimson Trace® laser.

LX-382 (green laser)



- In the LX-382 (green laser) Install one (1) CR1/3N lithium battery as shown (FIGURE A6). Proper battery orientation is clearly marked on the battery pocket of the Crimson Trace® laser.

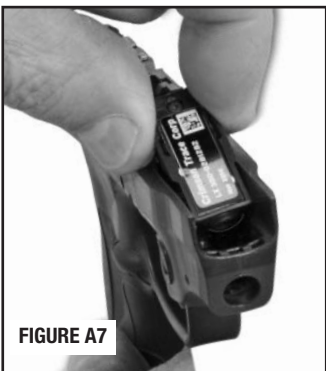

REMOVE / INSTALL CRIMSON TRACE® LASER CONTINUED

INSTALL THE CRIMSON TRACE® LASER INTO THE M&P SHIELD® M2.0™ PISTOL.

- With the lens pointing toward the front of the pistol frame - insert the laser into the round hole and tip the laser into position (FIGURES A7 and A8).
- Seat the laser fully into its recess and tighten the screw with the provided tool to lock it into place (FIGURE A9).



FIGURE A8



FIGURE A9

- Reassemble the pistol as detailed in the Field Stripping / Assembly Section of this manual.

CRIMSON TRACE® LASER ACTIVATION BUTTON(S)



WARNING: VISIBLE LASER RADIATION EMITS FROM THE CRIMSON TRACE® LASER WHILE IN OPERATION – AVOID DIRECT EYE EXPOSURE.

- The activation-button to turn the laser on and off is located at the front of the pistol frame (on both sides) (FIGURE A10).
- The table below illustrates modes of operation for the Crimson Trace® laser and the input required to activate them.



FIGURE A10

ON/PULSE/OFF ACTIVATION-BUTTON TABLE

Activation-Button Behavior		
Mode	User Input	Result
On	Push-Button 1x	Constant Laser
Pulse	Push-Button 2x	Pulse Laser
Off	Push-Button 3x	Off

ACTIVATION BUTTON(S) CONTINUED

- The Crimson Trace® laser is equipped with a five minute auto-off timer. After five minutes (± 15 seconds) of continuous activation, the laser will begin to flash. This is true even if the Crimson Trace® laser is being operated in Pulse Mode.

CRIMSON TRACE® LASER ADJUSTMENT AND ZEROING



WARNING: ENSURE YOUR FIREARM IS UNLOADED BEFORE ADJUSTING YOUR SIGHT. AT ALL TIMES FOLLOW THE BASIC FIREARMS SAFETY RULES IN THE SECTION ENTITLED "YOUR SAFETY RESPONSIBILITIES".



WARNING: VISIBLE LASER RADIATION EMITS FROM THE CRIMSON TRACE® LASER WHILE IT IS IN OPERATION – AVOID DIRECT EYE EXPOSURE.

- The Crimson Trace® laser is equipped with adjustment screws for independent movement of the laser beam for both windage and elevation. Adjustment screws can be turned using the provided hex wrench.
- Laser Adjustment Table (below): This table shows the direction of adjuster rotation (as viewed from above and behind the firearm) and the resultant direction of the laser beam and the shot group movement.

LASER ADJUSTMENT TABLE			
Windage or Elevation	Adjustment Screw Rotation	Laser Beam Movement	Shot Group Movement
Windage Adjustment	Clockwise	Right	Left
	Counter-Clockwise	Left	Right
Elevation Adjustment	Clockwise	Down	Up
	Counter-Clockwise	Up	Down

ZEROING PROCEDURE

The Crimson Trace® laser is factory preset to be nearly parallel with the barrel of the firearm and is pre-sighted at 25'. It is ready to be zeroed at any distance via live fire.



WARNING: ALWAYS BE SURE OF YOUR TARGET AND WHAT IS BEYOND IT WHEN FIRING.

LASER ADJUSTMENT AND ZEROING CONTINUED

CAUTION: One complete rotation of the adjustment screws in either direction provides ample beam movement for zeroing purposes. Turning the adjustment screws more than one complete rotation in either direction may result in damage to the Crimson Trace® laser.

NOTE: Direct sunlight may hinder the ability of the user to effectively see the laser beam on the target.

- Mount a target with a clearly visible aiming point downrange at the desired zeroing distance.
- Turn the Crimson Trace® laser ON by pressing the activation button on either side once.

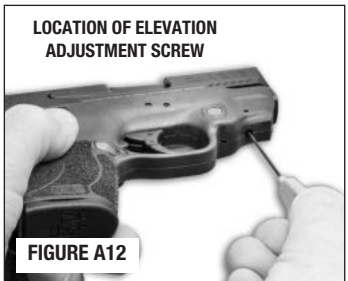

- While aiming the M&P SHIELD® M2.0™ with its iron sights, rotate the adjustment screws as needed to superimpose the laser strike point over the aiming point (FIGURE A13). To determine the required direction of rotation, refer to the Laser Adjustment Table on page 50.

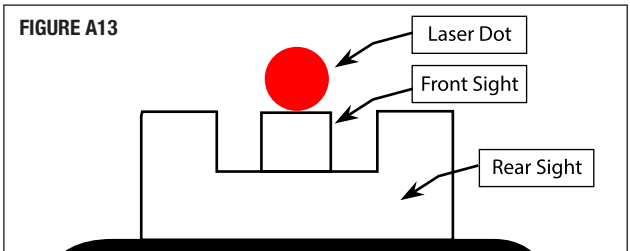

- Direct the Crimson Trace® laser at the target aiming point.
- Fire a 3-round shot group and note the center of the shot group relative to the target aiming point.
- Rotate the adjustment screws as needed to move the center of the shot group to the target aiming point. To determine the required direction of rotation, refer to the Shot Group Movement column in the Laser Adjustment Table on page 50.

LASER ADJUSTMENT AND ZEROING CONTINUED

- Fire another 3-round shot group to confirm zero.
- Repeat these steps until the shot group falls within an acceptable radius around the target aim point.
- The Crimson Trace® laser is now zeroed to the M&P SHIELD® M2.0™. Press the activation-button twice to turn the laser OFF.

NOTE: As with any sighting device, the location of the shot group is dependent on distance to the target. A group that is shot using the laser aiming point at one distance will not necessarily be aligned with the aiming point at a different distance. The user needs to become familiar with the trajectory of the round being used and adjust accordingly.

CRIMSON TRACE® LASER MAINTENANCE



WARNING: ENSURE YOUR FIREARM IS UNLOADED BEFORE PERFORMING MAINTENANCE ON YOUR CRIMSON TRACE® LASER. AT ALL TIMES FOLLOW THE BASIC FIREARMS SAFETY RULES IN THE SECTION ENTITLED “YOUR SAFETY RESPONSIBILITIES”.

NOTE: Remove the Crimson Trace® laser from the M&P SHIELD® M2.0™ before inspecting, cleaning or performing other maintenance functions.

The Crimson Trace® laser should be inspected before each use and after prolonged periods of non-use. The following procedures will prolong the life of the laser and help ensure safe operation. Crimson Trace laser sights require minimal attention and are designed to resist most common firearm chemicals and lubricants, however, excessive exposure to these chemicals can be detrimental. To ensure the safe and effective operation of your laser sights:

- Remove laser sight before cleaning gun.
- Do not use pressurized or compressed air.
- Do not immerse in cleaning fluid or lubricate firearm excessively. A firearm that has too much oil will foul the lens of the laser and result in an unfocused beam. This can be easily cleaned and causes no permanent damage.
- Do not allow cleaning solution to enter lens source.
- Do not allow solvents to contact your Laser that contain: VOCs or TCE such as: carburetor/brake cleaner, acetone, MEK, gasoline. Damage will result.

LASER MAINTENANCE CONTINUED

- Crimson Trace diodes are designed and positioned to minimize exposure. Occasional cleaning of the lens is recommended. After extensive shooting, you may notice a degradation of beam quality or “beam spread”. This is the result of fouling on the lens surface. This is normal and can be easily cleaned with the included cleaning swabs or a small cotton swab dipped in isopropyl alcohol or window cleaner.

Dry the lens with a clean dry swab. When cleaning the lens do not touch lens with any sharp objects.

Batteries: Inspect the batteries for cracks, dents, leakage or bulging. If a battery shows signs of damage, remove and dispose of properly. Replace batteries as required per battery handling section of this appendix.

Laser Aperture: The laser aperture may be cleaned using a soft cloth and water, alcohol or general purpose window cleaner. When cleaning the aperture do not touch with a sharp object that might scratch the surface.

CRIMSON TRACE® LASER LIMITED WARRANTY

Crimson Trace® Corporation (CTC) warrants that the LX-380 or LX-382 Laser product on the M&P SHIELD® M2.0™ pistol will be free from defects in materials and workmanship for a period of twelve (12) months from the date of purchase by the original owner. At its sole discretion, CTC will either repair or replace, at no charge, any LX-380 or LX-382 Laser product or part (with the exception of the batteries) which is found to be defective, under normal use and service, during the warranty period. CTC's obligation to either repair or replace shall be the owner's sole and exclusive remedy under this warranty. This warranty does not cover normal maintenance and service and does not apply to any products or parts that have been subject to modification, misuse, carelessness, accident, improper maintenance or repair other than by CTC.

This warranty also does not cover damage caused by faulty batteries. The battery manufacturer should be contacted in the event of a leak.

Warranty claims (in writing) and the Laser product concerned should be delivered to:

**Smith & Wesson
Customer Service Department
2100 Roosevelt Avenue,
Springfield, Massachusetts 01104**

CRIMSON TRACE® LASER WARRANTY CONTINUED

In addition, a copy of the bill of sale in the owner's name must be included. It is important that the owner comply with all applicable federal, state and local laws and regulations in the shipment of any firearm that is included with a Laser product.

Warranty claims should state the serial number (if any) of the Laser product and of the firearm included with the Laser product, and include a description of the difficulty experienced with the Laser product. It is recommended that shipments be insured by the owner, since neither CTC nor Smith & Wesson Inc. will accept any responsibility for loss or damage in transit.

This limited warranty extends only to the original owner of the CTC Laser product and there are no other warranties, expressed or implied other than as set forth in this limited warranty. CTC disclaims any warranties of merchantability and fitness for a particular purpose.

UNDER NO CIRCUMSTANCES SHALL CTC BE RESPONSIBLE FOR ANY INCIDENTAL, CONSEQUENTIAL OR SPECIAL DAMAGES ARISING OUT OF OR IN CONNECTION WITH PRODUCT USE OR PERFORMANCE, BREACH OF WARRANTY, NEGLIGENCE, OR OTHERWISE.

Some states do not allow the exclusion or limitation of incidental or consequential damages, so the above limitation or exclusion may not apply to you.

NOTE: All liability is excluded in the event that the instructions in this Appendix – "A" Operator Manual For The LX-380 or LX-382 Laser on the M&P SHIELD® M2.0™ Pistol are not observed.

CRIMSON TRACE® LASER SERVICE AND REPAIR

CONTACT SMITH & WESSON CUSTOMER SERVICE

Tel: 800-331-0852 ext. 4125

E-mail: qa@smith-wesson.com

RETURNS FOR SERVICE - FOR ISSUES INVOLVING THE LASER SIGHTING DEVICE

Smith & Wesson
2100 Roosevelt Avenue
Springfield, MA 01104

Should your laser-equipped Smith & Wesson® firearm require service specific to the laser device, it should be returned to the Smith & Wesson® factory.

CRIMSON TRACE® LASER SERVICE AND REPAIR CONTINUED

- Call or e-mail the Customer Service Dept. for authorization and shipping instructions.
- Ensure that the firearm is unloaded.
- **Do not attempt to ship a firearm via US Postal Service; only federally licensed dealers may ship a firearm by US Postal Service.**
- **DO NOT SHIP ANY AMMUNITION.**
- Enclose a letter which includes your full name and address (no P.O. Boxes, please), daytime telephone number, e-mail address, the serial number of the firearm, and details of the problem experienced (stating the brand and type of ammunition used when the problem occurred) or work desired.
- Record the serial number before shipping, in case you wish to check on the repair status of your firearm.
- Please remove all custom parts and accessories, such as stocks, special sights and scopes, or slings from your firearm before returning.
- Place the firearm in its original case or in a similarly secure container and pack it securely.
- The package must **NOT** bear any markings which indicate the identity of the contents.

CRIMSON TRACE® LASER LEGAL INFORMATION

The exportation of this product falls under the jurisdiction of the U.S. Commerce Department Bureau of Industry and Security and is subject to the Export Administration Regulations.

The LX-380 and LX-382 Laser is designed and produced by:
Crimson Trace Corporation
Wilsonville, Oregon, USA
www.crimsontrace.com



WARNING: THIS PRODUCT CONTAINS CHEMICALS KNOWN TO THE STATE OF CALIFORNIA TO CAUSE CANCER, OR BIRTH DEFECTS OR OTHER REPRODUCTIVE HARM.

Crimson Trace® holds several patents and may have other patents pending that cover its innovations. Please review individual products for patent numbers to determine the specific patent coverage or visit www.crimsontrace.com/company/patents for virtual patent information.

Crimson Trace® trademarks are property of Crimson Trace Corporation, Portland, Oregon, and are used by permission.

SHIELD MINI OPTICAL SIGHT ADDENDUM

For use on those M&P SHIELD® pistols with slide cut-out.



WARNING: ALWAYS KEEP YOUR FIREARM POINTED IN A SAFE DIRECTION. NEVER POINT A FIREARM AT ANYTHING YOU DO NOT INTEND TO SHOOT.



WARNING: NEVER ATTEMPT TO INSTALL A SIGHT MOUNT ON A LOADED FIREARM. ALWAYS ENSURE THAT THE FIREARM AND MAGAZINE IS NOT LOADED.



WARNING: WEAR SAFETY GLASSES SPECIFIED FOR USE WITH FIREARMS WHEN INSTALLING OR REMOVING THE OPTICAL SIGHT OR WHEN FIRING YOUR PISTOL WITH THE OPTICAL SIGHT INSTALLED.



WARNING: FAILURE TO HEED THESE WARNINGS MAY RESULT IN INJURY AND/OR DEATH TO THE USER OR BYSTANDERS AND DAMAGE TO PROPERTY.

NOTE: Once the battery is installed in the SHIELD Mini Optical sight the sight is always “on”. The red dot will be visible when looking through the sight from the rear. The battery should last approximately 2 years in normal conditions. Follow the instructions provided here to change the battery when the intensity of the red dot is diminished or it is no longer visible.

NOTE: The SHIELD Mini Optical sight can be installed or removed with the pistol fully assembled or field-stripped. Ensure that the pistol and magazine are unloaded before attempting any such procedure.

FIGURE B1 shows the component parts of the SHIELD Mini Optical sight package as it comes from the factory.

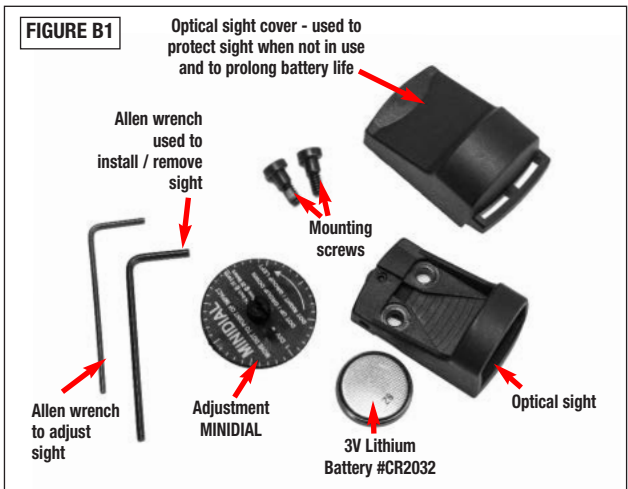

SHIELD MINI OPTICAL SIGHT INSTRUCTIONS CONTINUED

For use on those M&P SHIELD® pistols with slide cut-out.

- **Shield Mini Optical Sight**
Technical Data: Weight with battery - 0.5 oz (14 grams); Size 1.0 inch (25.4 mm) wide, 1.7 inch (42 mm) long, 0.9 inch (23 mm) high;

- FIGURE B2 shows the optical sight mounted on the slide with the cover on the sight.



- Lift the front of the sight cover by the tab to remove the sight cover (FIGURE B3).

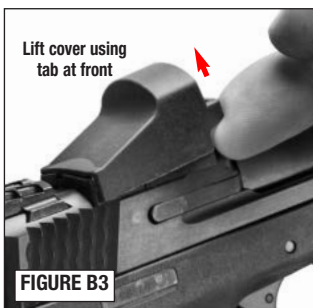

- The sight cover will help protect the sight when it is not in use - and the cover also prolongs the battery life by putting the sight in stand-by mode.



- With the sight cover removed, and a charged battery installed, a red dot appears on the lens when the user views the sight from the rear at arms length (FIGURE B5).

LED Insert: Consists of a micro-electronic unit contained within a robust waterproof encapsulated insert. This is mounted with gold plated battery contacts extending out at either side. The LED insert senses target light levels and controls the light output of the LED to give optimum visibility of the dot against the target.

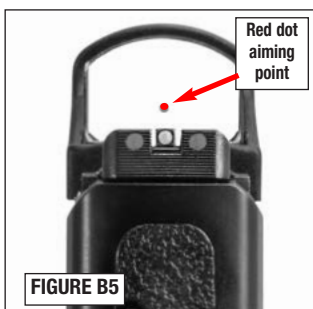

SHIELD MINI OPTICAL SIGHT INSTRUCTIONS CONTINUED

For use on those M&P SHIELD® pistols with slide cut-out.

- Remove the slide cap from the M&P SHIELD® pistol slide by unscrewing the two screws using a 5/64" hex wrench as shown here (FIGURES B6 through B9).

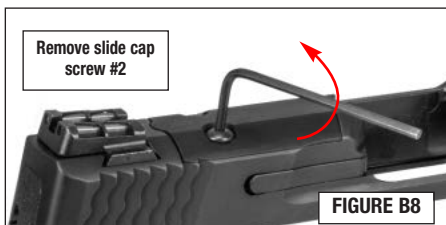
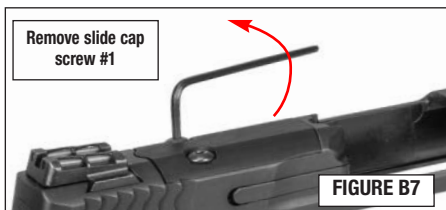

- Set the sight into position on the slide, taking care to seat the sight fully onto the alignment pegs (FIGURE B10).

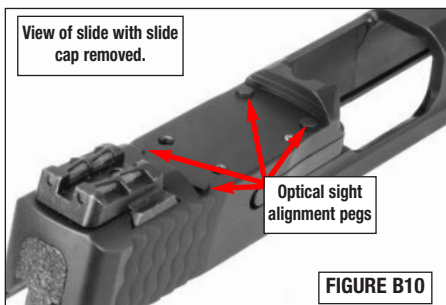

SHIELD MINI OPTICAL SIGHT INSTRUCTIONS CONTINUED

For use on those M&P SHIELD® pistols with slide cut-out.

- Install the two screws that were provided, and tighten them carefully to avoid cross-threading or stripping them (FIGURES B11 and B12). A 5/64" hex wrench is provided for this procedure.



WARNING: A SIGHT WHICH IS NOT MOUNTED SECURELY MAY BECOME DETACHED UPON RECOIL OF THE FIREARM. IF IT BECOMES DETACHED IT MAY FLY BACK AND STRIKE THE SHOOTER OR A BYSTANDER AND CAUSE INJURY. OBSERVE THE CONDITION OF THE MOUNTING SCREWS BEFORE AND AFTER FIRING. IF THE MOUNTING SCREWS SHOW SIGNS OF BEING LOOSE BEFORE FIRING OR LOOSENING UPON FIRING DO NOT FIRE THE PISTOL UNTIL YOU HAVE TIGHTENED THE SCREWS. THE USER MUST ENSURE THAT THE SCREWS ARE INSTALLED PROPERLY (NOT CROSS-THREADED OR STRIPPED) AND KEPT TIGHT DURING USE.

OPTICAL SIGHT ADJUSTMENT AND ZEROING

ALWAYS MAKE SURE THAT THE GUN IS UNLOADED AND THE CHAMBER IS CLEAR BEFORE ANY ADJUSTMENTS ARE MADE. ALWAYS BE SURE OF YOUR BACKSTOP.

- Insert the smaller of the two Allen wrenches provided through the MINIDIAL as shown (FIGURE B13).
- The red dot that shows up when you look through your sight from the rear (FIGURE B14) can be adjusted to affect the impact of bullets on target in relation to aiming point.

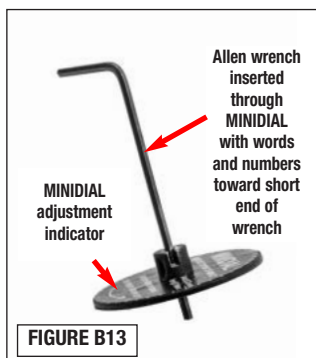

SHIELD MINI OPTICAL SIGHT INSTRUCTIONS CONTINUED

For use on those M&P SHIELD® pistols with slide cut-out.

NOTE: The red dot is adjusted toward your bullet's point of impact on target.

- Elevation adjustment - the elevation adjustments are on the top of your sight (FIGURE B15). To raise your point of impact, with the provided adjustment tool, turn the adjustment screw clockwise. Turning the screw a small amount is usually all that's necessary. To lower the point of impact turn the adjustment counter-clockwise.



- Windage adjustment - the windage adjustment screw is on the right side of your sight (FIGURE B16). To move your point of impact to the right, with the provided adjustment tool, turn the adjustment screw clockwise. Turning the screw a small amount is usually all that's necessary. To move the point of impact to the left, turn the adjustment screw counter-clockwise.

- The Mini Sight has an adjustment range of a total of 25 inches (650 mm) in windage and elevation at 20 yards (18 Meters). This is given by one full turn of the adjustment key in either direction. The MINI-DIAL has increments of one division, each giving 1/4 inch (6.3 mm) movement of the dot at 20 yards.

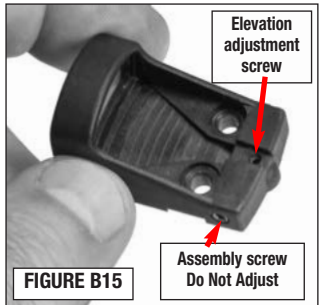

- Adjustment can be made to the windage and elevation using the supplied Allen wrench in conjunction with the MINIDIAL (FIGURE B17). To use the MINIDIAL, push the long arm of the Allen wrench just through the hole in the centre of the dial, with dial facing towards you. Using the short end of the Allen wrench, protruding from the back of the MINIDIAL, turn the windage side screw clockwise, this moves the dot in the direction of the arrow indicated on the MINIDIAL. Move dot left by clockwise rotation of the Allen screw, move dot right by counter clockwise rotation of the same screw. Move dot down by clockwise rotation of the top adjustment screw, move dot up by anti-clockwise rotation of the same screw.

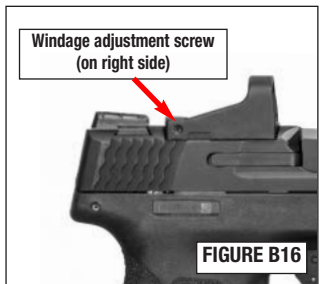

SHIELD MINI OPTICAL SIGHT INSTRUCTIONS CONTINUED

For use on those M&P SHIELD® pistols with slide cut-out.

Use Allen wrench and MINIDIAL to help adjust sight

FIGURE B17



- DO NOT force adjustment, in either direction, once resistance is felt, as this will damage the body. The left side sealed screw is used to set up the spring load of the adjustment system and will not require adjustment.
- The adjustment Allen wrench can be conveniently stored and carried cross-ways in the slot in the stem of the MINIDIAL.
- Remember - Always move dot towards the point of impact, so if a group shot is high and right of the centre of the target, then move the dot up and to the right to cover the position of the group.
- The MINIDIAL is marked with divisions of $\frac{1}{4}$ inch at 20 yards (6 mm. At 20 meters). So for example if the target is at 10 yards (10m) and the group is 1 inch (25 mm) high, then the MINIDIAL has to be turned 8 divisions counter clockwise on the elevation Allen screw, because at 20 yards (20 m) this would represent 2 inches (50 mm).

When the sight is not in use - install the cover to prolong battery life and to protect the sight



FIGURE B18

SHIELD MINI OPTICAL SIGHT INSTRUCTIONS CONTINUED

For use on those M&P SHIELD® pistols with slide cut-out.

INSTALLING A BATTERY

- The battery is located beneath the optical sight and is accessed by removing the sight from the pistol (FIG B19).
- Remove the optical sight by turning the mounting screws counter-clockwise using a 5/64" hex wrench (FIG. B20).
- Install the 3V Lithium #CR2032 battery with the positive (+) side facing down (FIG. B21).
- A slot on one of the alignment holes allows a battery to be pried out of the recess (FIGURE B22)

Battery Note: Under average use the battery can last 2 to 3 years. Replacement is required when the intensity of the dot appears greatly diminished against a bright background. When inserted, the positive side (+) of the battery should be upward and visible. The side of the battery should be pressed against the contacts before being inserted. The negative (-) contact must be properly situated in its recess at the bottom of the battery cavity, should it be bent out of position it may touch the positive (+) side of the battery, and the LED will not work. To remove a battery, use the allen key to prise the battery from its cavity with the key placed in the slot, which is part of one of the forward mount location holes.

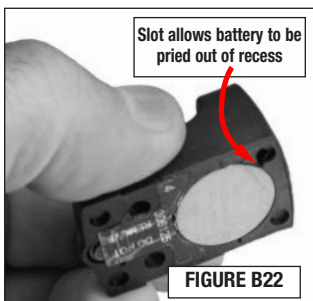
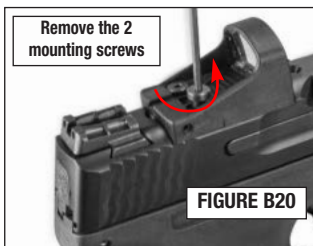
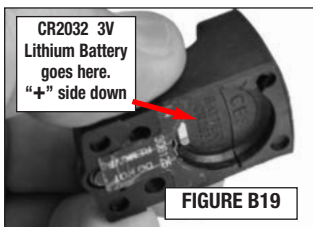

Temperature range -20 to +40 degrees centigrade; Dark storage battery life approx. 4 years.

SHIELD MINI OPTICAL SIGHT INSTRUCTIONS CONTINUED

For use on those M&P SHIELD® pistols with slide cut-out.

OPTICAL SIGHT LENS CARE

The Lens is made from a polymer as opposed to glass which allows for great strength and little weight. It has an anti-reflective coating. The polymer may show some minor distortion if examined under intense scrutiny such as holding the sight up to a light and focusing on the lens. When you are actually shooting, the eye never focuses on the lens, so this distortion is not noticeable under live fire conditions. To ensure the lens stays scratch free only ever clean it with a lens cleaner and lens pen or carefully with a clean lens cloth. NEVER clean with tissue or dry cloth. Be sure to blow away any debris before initiating the cleaning process and, when not in use, protect with sight cover.

SERVICE AND REPAIR OF THE OPTICAL SIGHT

- If you have any questions about the installation of an optical sight on your M&P SHIELD® pistol using this system, contact the Customer Service Department.

SMITH & WESSON CUSTOMER SERVICE

Tel: 800-331-0852 ext. 4125

E-mail: qa@smith-wesson.com

Smith & Wesson

2100 Roosevelt Avenue

Springfield, MA 01104

SHIELD MINI OPTICAL SIGHT INSTRUCTIONS CONTINUED

For use on those M&P SHIELD® pistols with slide cut-out.

SHIELD Mini Optical Sight Guarantee:

This guarantee, which is provided by the manufacturer of the sight (Shield Firearms & Sights, Ltd.), is valid for a period of 2 years on the condition that the SHIELD Mini Optical sight was purchased new. The manufacturer, through Smith & Wesson, will undertake to remedy the situation where faults in construction, materials and manufacture of the optical sight which have become apparent during normal use and to which the purchaser has made claim to Smith & Wesson® with proof of purchase.

This guarantee is valid only for faults in construction, materials and manufacture, and does not cover normal wear, faults that occur due to misuse or negligent maintenance, or unauthorized modifications carried out by the user or third parties.

IMPORTANT NOTICE TO PURCHASER: The following is made in lieu of all warranties, expressed or implied, including the implied warranties of merchantability and fitness for purpose: Seller's and manufacturer's only obligation shall be to replace such elements of the product proved to be defective. Before using, user shall determine the suitability of the product for its intended use, and user assumes all risk and liability whatsoever in connection therewith. **NEITHER SELLER NOR MANUFACTURER SHALL BE LIABLE EITHER IN TORT OR IN CONTRACT FOR ANY LOSS OR DAMAGE, DIRECT, INCIDENTAL, OR CONSEQUENTIAL, ARISING OUT OF THE USE OR THE INABILITY TO USE THE PRODUCT.**

- If your SHIELD Mini Optical sight should require repair or service, call the Customer Service Dept. at 1-800-331-0852, extension 4125 or, e-mail the Customer Service Dept. at qa@smith-wesson.com for authorization and shipping instructions.

This handgun is not equipped with a device that fully blocks use by unauthorized users. More than 200,000 firearms like this one are stolen from their owners every year in the United States. In addition, there are more than a thousand suicides each year by younger children and teenagers who get access to firearms. Hundreds more die from accidental discharge. It is likely that many more children sustain serious wounds or inflict such wounds accidentally on others. In order to limit the chance of such misuse, it is imperative that you keep this weapon locked in a secure place and take other steps necessary to limit the possibility of theft or accident. Failure to take reasonable preventative steps may result in innocent lives being lost, and in some circumstances may result in your liability for these deaths.

The certification below is required only for handguns sold in the United States with a barrel length shorter than 3".

Smith & Wesson Inc. hereby certifies average accuracy test results for all new handguns with a barrel shorter than 3" as follows:

7 yards	14 yards	21 yards
1.7"	3.9"	6.3"

This certification is based on tests conducted by Smith & Wesson Inc. using a fixed handgun, rest and firing ammunition manufactured by a member of the Shooting Arms and Ammunition Manufacturers Institute (SAAMI) as defined in ANSI/SAAMI Z299.3-1993.

This certification represents actual tests based on several handguns, selected at random. Your particular handgun may have accuracy better than the results stated in this certification.

CUSTOM SERVICE

We understand that Smith & Wesson® gun owners may want to enhance their guns with custom gunsmithing, refinishing or accessories. Our gunsmiths offer specialized services and exclusive products to enhance your shooting experience.

Accessories for your Smith & Wesson® firearm are available from your local Smith & Wesson® Stocking Dealer, or directly from Smith & Wesson®.

Contact the Customer Service Department at 1-800-331-0852, extension 4125 for information about these services.

When ordering directly from the factory, please provide the following information:

- Model Number
- Dash Number
- Serial Number
- Approximate date of purchase
- Complete Return Address
- VISA/Discover/MasterCard Number & Expiration Date
- For Foreign Orders Only, Fax Number or E-mail Address

BATTERY WARNINGS



WARNING: IF A BATTERY OPERATED ACCESSORY OR ATTACHMENT (I.E. LASER, OPTICAL SIGHT OR FLASH-LIGHT, ETC.) IS SUPPLIED OR USED WITH THIS FIREARM, THE FOLLOWING WARNINGS AND INSTRUCTIONS MUST BE ADHERED TO.



WARNING: KEEP BATTERIES AWAY FROM CHILDREN. THERE IS A CHEMICAL BURN HAZARD ASSOCIATED WITH BATTERIES.



WARNING: IF A NEW OR USED LITHIUM BUTTON/COIN CELL BATTERY IS SWALLOWED OR ENTERS THE BODY, IT CAN CAUSE SEVERE INTERNAL BURNS AND CAN LEAD TO DEATH IN AS LITTLE AS 2 HOURS. ALWAYS COMPLETELY SECURE THE BATTERY COMPARTMENT. IF THE BATTERY COMPARTMENT DOES NOT CLOSE SECURELY, STOP USING THE PRODUCT, REMOVE THE BATTERIES, AND KEEP IT AWAY FROM CHILDREN. IF YOU THINK BATTERIES MIGHT HAVE BEEN SWALLOWED OR PLACED INSIDE ANY PART OF THE BODY, SEEK IMMEDIATE MEDICAL ATTENTION.

- When used correctly, batteries provide a safe and dependable source of portable power. However, misuse or abuse may result in leakage, fire, or explosion.
- Batteries can explode or leak and cause burns if installed backwards, disassembled, charged, or exposed to water, fire or high temperature.
- Always take care to install your batteries correctly observing the “+” and “-” marks on the battery and the device.
- Always replace the whole set of batteries at one time, taking care not to mix old and new batteries, or batteries of different types.
- Store unused batteries in their original packaging and away from metal objects that may short-circuit them.
- Remove discharged batteries from equipment promptly to avoid possible damage from leakage.
- Never dispose of batteries in fire. (Failure to observe this precaution may result in an explosion.)
- The batteries are supplied in a charged state and are not designed for recharging. Recharging may cause leakage, fire, or explosion.
- The batteries should be disposed of properly, including keeping them away from children.
- Dispose of used batteries immediately. Even used batteries may cause injury.

PATENT INFORMATION

- This product may be covered by one or more patents. Visit www.smith-wesson.com for virtual patent information.

INTERNATIONAL WARRANTY CENTERS

NOTE: Addresses and other contact information for international Warranty Centers are available on the Smith & Wesson® website at www.smith-wesson.com or by calling Customer Service toll-free at 1-800-331-0852 ext 4125.



3009898

Smith & Wesson
2100 Roosevelt Avenue • Springfield, MA 01104
www.smith-wesson.com

p/n 3009898

REV:M&P_SHIELD_100119

68