

M&P[®]

by **Smith & Wesson[®]**

Safety & Instruction Manual



M&P[®] BODYGUARD[®] 38

with Integrated Crimson Trace[®] Laser Sight



**Read the instructions and
warnings in this manual
CAREFULLY BEFORE
using this firearm.**

2100 Roosevelt Avenue • Springfield, MA 01104
1-800-331-0852 • Fax: 413-747-3317
www.smith-wesson.com

Copyright © 2015 Smith & Wesson Corp.
All rights reserved.



WARNING



**READ THESE
INSTRUCTIONS AND WARNINGS
CAREFULLY. BE SURE YOU
UNDERSTAND THESE
INSTRUCTIONS AND WARNINGS
BEFORE USING THIS FIREARM.
FAILURE TO READ THESE
INSTRUCTIONS AND TO FOLLOW
THESE WARNINGS MAY RESULT
IN SERIOUS INJURY OR DEATH
TO YOU AND OTHERS AND
DAMAGE TO PROPERTY.**

**This SAFETY & INSTRUCTION
MANUAL should always
accompany this firearm and be
transferred with it upon change of
ownership or when presented to
another person. A copy of the
SAFETY & INSTRUCTION
MANUAL is available FREE
via download at
www.smith-wesson.com
or upon request from:**

**SMITH & WESSON®
CUSTOMER SUPPORT CENTER
2100 ROOSEVELT AVENUE
SPRINGFIELD, MA 01104
TEL.: 1-800-331-0852, ext. 4125
E-mail: qa@smith-wesson.com**

TABLE OF CONTENTS

YOUR SAFETY RESPONSIBILITIES	3-7
SAFE STORAGE & TRANSPORTATION	7-8
AMMUNITION	9-11
AMMUNITION SELECTION FOR LW REVOLVERS	12
MODEL & FEATURES IDENTIFICATION	13
INSPECTING YOUR REVOLVER	14
PREPARATION FOR FIRING	15
LOADING	16
FIRING	17-18
CLEARING MISFIRES	18
UNLOADING	19
GUNSMITH ADVISORY	20
CLEANING & MAINTENANCE	20-22
LIMITED WARRANTY	23-24
CONTACT & SHIPPING INFORMATION	25-26
CUSTOM SERVICE	27
WARRANTY CENTERS	29
APPENDIX "A" CRIMSON TRACE® LASER	30-43
NOTES	44-47
PATENT INFORMATION	48

YOUR SAFETY RESPONSIBILITIES

SAFETY IS YOUR NUMBER ONE RESPONSIBILITY!!!!

At home, in the field, at the range, or anywhere, the first concern of every firearm owner should be safety. Apply the following safety rules in every situation, with any kind of firearm. If you feel uncertain about any operational aspects of your firearm, please contact Smith & Wesson at 1-800-331-0852, ext. 2905 before proceeding with its operation.

If you are unfamiliar with firearms you should seek formal training before using your revolver.



WARNING: YOU MUST FOLLOW ALL OF THESE SAFETY RULES TO ENSURE THE SAFE USE OF YOUR FIREARM. THE FAILURE TO FOLLOW THE INSTRUCTIONS AND WARNINGS IN THIS MANUAL COULD CAUSE SERIOUS PERSONAL INJURY OR DEATH TO YOU OR OTHERS AND DAMAGE TO PROPERTY.

As a gun owner, you accept a demanding responsibility. How seriously you take this responsibility can be the difference between life and death. There is no excuse for careless or abusive handling of your firearm. At all times handle your firearm with intense respect for its power and potential danger.

YOUR SAFETY RESPONSIBILITIES CONT'D

- **ALWAYS KEEP YOUR FIREARM POINTED IN A SAFE DIRECTION.** Never point a firearm at anyone or anything you do not intend to shoot whether or not it is loaded. This is particularly important when loading, unloading, or cleaning the firearm. ALWAYS control the direction of the firearm.
- **ALWAYS TREAT EVERY FIREARM AS IF IT IS LOADED AND WILL FIRE.** Do not take anyone's word that the firearm is unloaded – always check for yourself. Never pass your firearm to another person until the cylinder or action is open and you visually check that it is unloaded. Keep your firearm unloaded and safely stored when not in use.
- **NEVER PLACE YOUR FINGER INSIDE THE TRIGGER GUARD OR ON THE TRIGGER UNLESS YOU INTEND TO FIRE.** Ensure that other objects do not touch the trigger.
- **ALWAYS BE SURE OF YOUR TARGET AND WHAT IS BEYOND IT.** Always be sure of where the bullet will strike and shoot only where there is a safe back stop free of obstructions, water or other surfaces which can cause ricochets. Be sure your bullet will stop behind your target. Bullets can glance off many surfaces like rocks or the surface of water and travel in unpredictable directions with considerable velocity. Do not fire randomly into the sky.
- **NEVER CROSS OBSTACLES SUCH AS FENCES OR STREAMS WITH A LOADED FIREARM.** Always make certain your firearm is unloaded before crossing a fence, climbing a tree, jumping a ditch or negotiating other obstacles.
- **SAFE GUN HANDLING IS YOUR PERSONAL RESPONSIBILITY AT ALL TIMES.** Firearms are dangerous and can cause serious injury or death if they are misused or used inappropriately. Safety must be the prime consideration of any one who owns or handles firearms. Accidents are the result of violating the rules of safe gun handling and common sense. Firearm safety training is available. Contact your firearms dealer, law enforcement agency, local sportsman's club, etc. for availability.
- **YOU ARE RESPONSIBLE FOR THE FIREARM AT ALL TIMES.** In owning a firearm, you must undertake full-time responsibility for your firearm's safety and security. You must protect yourself and all others against injury or death from misuse of the firearm 24 hours a day.
- **FIREARM SECURITY IS YOUR RESPONSIBILITY.** You must secure firearms safely from children and/or unauthorized users. Your firearm should always be kept unloaded and locked when not in use. A lock has been provided for this purpose. Never assume that the use of this lock is sufficient to safely secure your firearm. You must always evaluate your personal situation and employ the security systems that meet your needs and prevent children and unauthorized users from gaining access to your firearm.

YOUR SAFETY RESPONSIBILITIES CONT'D

- **APPROPRIATE USE FOR YOUR FIREARM MEANS USING YOUR FIREARM FOR LEGAL PURPOSES.** For example - target shooting, hunting and lawful resistance of deadly criminal force. It is your responsibility to ensure that you are in compliance with all applicable laws and ordinances regarding the use of your firearm.
- **NEVER RELY ON MECHANICAL FEATURES ALONE.** Only your safe gun-handling habits will ensure the safe use of your firearm. This is your responsibility.
- **ALWAYS SAFELY STORE AND SECURE YOUR FIREARM.** Safe and secure storage of your firearm is one of your most important responsibilities. It is a full-time responsibility. You must always secure your firearm and ammunition separately so that they are not accessible to children and/or other unauthorized persons.
- **NEVER KEEP AMMUNITION IN THE SAME LOCATION AS THE FIREARM.** Store each in a separate and secure place.
- **ALWAYS WEAR EYE PROTECTION THAT IS SPECIFIED FOR USE WITH FIREARMS** every time you handle your firearm for cleaning and maintenance.
- **ALWAYS WEAR EYE AND EAR PROTECTORS THAT ARE SPECIFIED FOR USE WITH FIREARMS** every time you discharge your firearm. Make sure others in the vicinity of where you will be shooting do so as well.
- **VISIBLE LASER RADIATION EMITS FROM THE CRIMSON TRACE® LASER SIGHT WHILE THE LASER SIGHT IS IN OPERATION – AVOID DIRECT EYE EXPOSURE TO LASER BEAM.**
 - Do not stare into the laser beam.
 - Do not look into the laser beam through binoculars or telescopes.
 - Do not point the laser beam at mirror-like surfaces.
 - Do not shine the laser beam into another individual's eyes.
- **NEVER USE ALCOHOL OR DRUGS BEFORE OR WHILE SHOOTING.** Do not use your firearm if you are on any medication which impairs, even slightly, your mental or physical ability.
- **ALWAYS HAVE ADEQUATE VENTILATION.** Discharging firearms in poorly ventilated areas, cleaning firearms, or handling ammunition may result in exposure to lead and other substances known to cause birth defects, reproductive harm, and other serious physical injury. Review the warnings and labels for all ammunition and cleaning products carefully. Wash hands thoroughly after exposure.

YOUR SAFETY RESPONSIBILITIES CONT'D

- **BEFORE HANDLING ANY FIREARM, UNDERSTAND ITS OPERATION.** Not all firearms are the same. Familiarize yourself with the mechanical features of any firearm you intend to use. If you feel uncertain about any operational aspects of your firearm, please contact Smith & Wesson at 1-800-331-0852, ext. 2905 before proceeding with its operation.
- **NEVER ALLOW A FIREARM TO BE USED BY INDIVIDUALS WHO DO NOT UNDERSTAND ITS SAFE OPERATION OR HAVE NOT READ THESE FIREARM SAFETY RULES.**
- **ALWAYS USE THE CORRECT AMMUNITION FOR YOUR PARTICULAR FIREARM** as indicated by the marking on the barrel. Never use non-standard, reloaded, or “handloaded” ammunition which has not been subjected to internal ballistic pressure testing.
- **BEWARE OF BARREL OBSTRUCTIONS** Be sure the barrel is clear of obstructions before shooting. Mud, water, snow or other objects may inadvertently lodge in the barrel bore. A small obstruction can cause a dangerous increase in pressure and may damage your gun and cause injury to yourself and others.
- **BE SURE ALL ACCESSORIES, SUCH AS HOLSTERS, GRIPS, SLINGS, SCOPES AND OTHER ACCESSORIES ARE COMPATIBLE** with the firearm and that the accessories do not interfere with safe operation. It is your responsibility to understand and follow all of the instructions in this manual, as well as those which may be supplied with your ammunition and any accessory.
- **NEVER DISASSEMBLE YOUR FIREARM** beyond the procedures outlined in this manual. Improper disassembly or reassembly of your firearm may be dangerous and can lead to serious injury or death.
- **NEVER MANIPULATE, ADJUST OR CHANGE ANY OF THE INTERNAL COMPONENTS OF YOUR FIREARM UNLESS SPECIFICALLY INSTRUCTED TO DO SO IN THIS MANUAL.** Improper manipulation of any other internal component may affect the safety and reliability of your firearm and may cause serious injury or death.
- **NEVER ALLOW ANY ALTERATION OR REPLACEMENT OF PARTS IN YOUR SMITH & WESSON FIREARM UNLESS PERFORMED BY A QUALIFIED GUNSMITH** using genuine Smith & Wesson parts. If you do otherwise, improper functioning of your firearm may occur and serious injury or death and damage to property may result.

YOUR SAFETY RESPONSIBILITIES CONT'D



WARNING: SAFE USE OF A FIREARM IS YOUR PERSONAL RESPONSIBILITY AND THE FAILURE TO FOLLOW ALL OF THESE BASIC SAFETY RULES MAY RESULT IN SEVERE PERSONAL INJURY OR DEATH TO YOU OR OTHERS AND DAMAGE TO PROPERTY. YOU ARE THE MOST IMPORTANT SAFETY DEVICE WHEN IT COMES TO THE USE OF YOUR FIREARM AND SMITH & WESSON WILL NOT BE RESPONSIBLE FOR ANY PERSONAL INJURY, DEATH OR PROPERTY DAMAGE THAT RESULTS FROM: (1) THE CRIMINAL OR NEGLIGENT USE OF THIS FIREARM; (2) A DISREGARD OF THESE SAFETY INSTRUCTIONS AND WARNINGS; (3) IMPROPER OR CARELESS HANDLING OF THIS FIREARM; (4) THE USE OF NON-STANDARD, DEFECTIVE, IMPROPER OR RELOADED AMMUNITION; OR (5) IMPROPER OR NEGLIGENT MODIFICATIONS OR REPAIRS TO THE FIREARM.

SAFE STORAGE & TRANSPORTATION



WARNING: ALWAYS POINT THE MUZZLE IN A SAFE DIRECTION.



WARNING: FIREARMS ARE DANGEROUS WHEN USED AND STORED IMPROPERLY. THEY POSE A RISK OF SERIOUS OR FATAL INJURIES. FIREARMS CAN BE ESPECIALLY DANGEROUS TO CHILDREN WHEN THEY ARE STORED IN AN IRRESPONSIBLE AND UNSAFE MANNER. FOR YOUR SAFETY AND THE SAFETY OF OTHERS, IT IS IMPERATIVE THAT YOU KEEP YOUR FIREARM LOCKED AND UNLOADED IN A SECURE PLACE. THE AMMUNITION SHOULD BE STORED IN A SEPARATE, SECURE LOCATION WHEN IT IS NOT IN USE. SAFE AND SECURE STORAGE OF YOUR FIREARM IS ONE OF THE MOST IMPORTANT RULES OF FIREARM SAFETY. YOUR FAILURE TO FOLLOW THESE RULES MAY RESULT IN SERIOUS INJURY OR DEATH TO YOU OR OTHERS.

- **ALWAYS SECURE YOUR FIREARM IN A MANNER THAT WILL PREVENT UNAUTHORIZED ACCESS.** Whenever your firearm is not in use, keep it unloaded and locked. Your safety and the safety of others requires that you always secure and store your firearm in a manner that will prevent unauthorized access. Never leave a firearm unattended unless it is locked, unloaded and secured.

STORAGE & TRANSPORTATION CONT'D

- **ALWAYS USE THE LOCK PROVIDED BY SMITH & WESSON TO SECURE YOUR FIREARM.** Please read and follow the instructions packaged separately for the use of this lock. A lock, when properly used, can be an effective tool in preventing unauthorized access to your firearm. There are other alternative locks and safe storage containers available in the marketplace which may also be appropriate for your particular needs. Consult your local gun shop, hardware store, or local police department for guidance on the variety of other safe storage devices or practices which may be appropriate for your particular needs. By purchasing this firearm you have accepted the responsibility of safely securing the firearm at all times and preventing its unauthorized use. Never assume that the use of this lock alone is sufficient to safely secure your firearm. It is your personal responsibility to select and use whatever measures or practices that will enable you to be absolutely certain that your firearm is secure at all times.



WARNING: NEVER LOCK A LOADED FIREARM AND NEVER LOAD A LOCKED FIREARM!

- **ALWAYS STORE YOUR FIREARM AND AMMUNITION SEPARATELY** so that they are not accessible to children or other unauthorized persons. Safe and secure storage of your firearm and ammunition are your responsibility. It is a full-time responsibility.
- **NEVER ASSUME THAT A "HIDING" PLACE IS A SECURE STORAGE METHOD.** Others may be aware of your storage location or come upon it by chance. It is your personal responsibility to use common sense when storing your firearm and ammunition and to always make sure they are not accessible to children or other unauthorized persons.
- **NEVER TRANSPORT A LOADED FIREARM.** When transporting your firearm, be sure it is unloaded and locked. Safe and secure transportation of your firearm is your responsibility.
- **ALWAYS FOLLOW THE LAW!** Many jurisdictions have laws that make it a crime to keep a firearm unlocked and in an area accessible to children or others. Keeping a firearm locked and unloaded when not in use is not only common sense safety practice... IT IS THE LAW. You must be familiar with all local, state, and federal laws regarding the safe storage and transportation of your firearm. Failure to know and follow the law may result in unauthorized access or use of your firearm by another. Obey all laws relating to the storage and transportation of firearms. Your local police department or gun shop can furnish you with available information on storing and/or transporting a firearm safely and legally.
- **YOUR FIREARM IS YOUR RESPONSIBILITY.** You must prevent your firearm from being stolen or from being used by untrained or unqualified individuals. Keep it locked, unloaded and secured when not in use.

AMMUNITION



WARNING: NEVER USE AMMUNITION NOT SPECIFICALLY DESIGNATED FOR USE IN YOUR FIREARM. FAILURE TO USE THE CORRECT TYPE OR CALIBER OF AMMUNITION MAY CAUSE THE FIREARM TO JAM, OR FAIL TO FIRE, OR MAY GENERATE EXCESSIVE PRESSURE WHICH CAN DAMAGE OR EVEN RUPTURE YOUR FIREARM, CAUSING PERSONAL INJURY OR DEATH TO THE SHOOTER OR BYSTANDERS.

Locate the cartridge designation marked on the firearm. This information indicates the correct ammunition that must be used in this firearm (FIGURE 1).

You are responsible for selecting ammunition that meets industry standards and is appropriate in type and caliber for this firearm.

Never mix ammunition.



ALTERNATE AMMUNITION: Select cartridges can be used in firearms so marked from the following list:

Caliber Marked on Barrel

.38 Special +P,

Can also Fire

.38 Special



WARNING: IN SOME CASES, A ROUND OF AMMUNITION NOT SPECIFIED ON YOUR FIREARM AND NOT LISTED AS ALTERNATE AMMUNITION IN THIS MANUAL, MAY FIT INTO THE CHAMBER. FIRING THIS AMMUNITION MAY CAUSE A RUPTURE RESULTING IN DAMAGE TO THE FIREARM AND PERSONAL INJURY OR DEATH TO THE SHOOTER OR BYSTANDERS. FOR MORE INFORMATION REGARDING UNSAFE CALIBER COMBINATIONS, REFER TO THE FOLLOWING URL: [HTTP://WWW.SAAMI.ORG/SPECIFICATIONS_AND_INFORMATION/PUBLICATIONS/DOWNLOAD/SAAMI_ITEM_211-UNSAFE_ARMS_AND_AMMUNITION_COMBINATIONS.PDF](http://www.saami.org/specifications_and_information/publications/download/saami_item_211-unsafe_arms_and_ammunition_combinations.pdf)



WARNING: ALWAYS INSPECT YOUR AMMUNITION BEFORE USING IT. NEVER USE DIRTY, CORRODED OR DAMAGED AMMUNITION. A BURST CARTRIDGE MAY RESULT CAUSING DAMAGE TO THE FIREARM AND PERSONAL INJURY OR DEATH TO THE SHOOTER OR BYSTANDERS.

Use only commercially manufactured ammunition with internal ballistic pressures which are in strict accordance with the specifications of the Sporting Arms and Ammunition Manufacturers' Institute (SAAMI). If you are uncertain, contact your ammunition supplier for verification.

AMMUNITION CONT'D



WARNING: NEVER USE NON-STANDARD, RELOADED OR "HANDLOADED" AMMUNITION WHICH HAS NOT BEEN SUBJECTED TO INTERNAL BALLISTIC PRESSURE TESTING. RELOADED OR HANDLOADED AMMUNITION, MAY HAVE MANY MANUFACTURING AND QUALITY VARIABLES (SUCH AS THE TYPE AND AMOUNT OF GUN POWDER). CARTRIDGE CASES THAT HAVE BEEN RELOADED AND FIRED MULTIPLE TIMES MAY SUFFER PHYSICAL DAMAGE WHICH COULD SIGNIFICANTLY IMPACT OR REDUCE THE INTEGRITY OF THE CARTRIDGE, POSSIBLY RESULTING IN BULLET SETBACK OR UNSEATING. CASE FAILURE AND INJURY TO THE SHOOTER OR BYSTANDERS AND DAMAGE TO THE FIREARM MAY RESULT WHEN SUCH A ROUND IS FIRED. ANY AMMUNITION THAT IS IMPROPERLY MANUFACTURED OR RELOADED, EVEN IN THE SLIGHTEST DEGREE, MAY FAIL TO FIRE OR MAY GENERATE EXCESSIVE INTERNAL PRESSURES WHICH CAN DAMAGE OR EVEN RUPTURE THE FIREARM, CAUSING PERSONAL INJURY OR DEATH TO THE SHOOTER OR THOSE IN THE IMMEDIATE VICINITY.

A firearm and ammunition are a system and must work together. There are different types of ammunition for different types of firearms. Your firearm has been designed for ammunition of a specific type and a specific gauge or caliber. It is important to select the proper ammunition for your firearm.

Different combinations of bullet velocity, bullet weight and firearm weight can have major impact on felt recoil; high felt recoil can be uncomfortable to some shooters.

For example:

- Firearm Weight: lower firearm weight increases felt recoil.
- Bullet Weight: higher bullet weight increases felt recoil.
- Bullet Velocity: higher bullet velocity increases felt recoil.

To acclimate yourself to higher levels of felt recoil, consider the following:

- Use a firm two-hand hold on the grip when firing.
- Always start your shooting experience with the lowest bullet velocity and lowest bullet weight available for your firearm.
- Ask your firearm dealer to suggest the lowest power, lowest velocity, lightest bullet weight for your firearm.

AMMUNITION CONT'D



WARNING: NEVER USE AMMUNITION OF THE INCORRECT GAUGE OR CALIBER. USING AMMUNITION OF THE INCORRECT GAUGE OR CALIBER MAY CAUSE DAMAGE TO YOUR FIREARM AND POSSIBLE SERIOUS INJURY TO YOU AND TO OTHERS.



WARNING: NEVER USE CARTRIDGES OTHER THAN THOSE DESIGNATED BY THE MARKING ON THE FIREARM. DOING SO CAN RESULT IN DANGEROUSLY HIGH PRESSURES THAT MAY DAMAGE THE FIREARM AND POSSIBLY CAUSE SERIOUS INJURY TO YOURSELF AND OTHERS.



WARNING: DEATH, SERIOUS INJURY AND DAMAGE TO PROPERTY CAN RESULT FROM THE USE OF INCORRECT AMMUNITION OR BORE OBSTRUCTIONS. NEVER USE RELOADS OF ANY KIND.

“Plus-P” (+P) ammunition generates pressures in excess of the pressures associated with standard ammunition. Such pressures may affect the wear characteristics or exceed the margin of safety. Use of “Plus-P” ammunition may result in the need for more frequent service.

“Plus-P-Plus” (+P+) ammunition must not be used in Smith & Wesson firearms. This marking on the ammunition designates that it exceeds established industry standards, but the designation does not represent defined pressure limits and therefore such ammunition may vary significantly as to the pressures generated and could be DANGEROUS.

Some brands of ammunition may cause difficulty in extracting spent cartridge cases from the chamber. If this situation occurs, thoroughly clean the chamber with solvent. If this condition persists, we recommend changing to another brand of ammunition.

AMMUNITION SELECTION FOR LIGHTWEIGHT REVOLVERS

Before placing reduced weight revolvers into service, perform the following test to determine the suitability of the ammunition you intend to use.

At a gun range or other suitable and safe location, prepare your revolver for firing by fully loading its cylinder with the ammunition to be tested. While pointing the firearm in a safe direction, fire 4 of the five rounds in the cylinder. Remove the four empty casings and the remaining loaded round from the revolver's cylinder. Carefully inspect the loaded round that you just removed from the cylinder to determine if the bullet has started to unseat (move forward) from its casing (FIGURE 2). If it has, you should not use the tested ammunition in your revolver. Choose another projectile weight or brand of ammunition and repeat this test until you find one that **DOES NOT UNSEAT** under these test conditions.

When you are finished testing, unload your revolver and secure it safely.

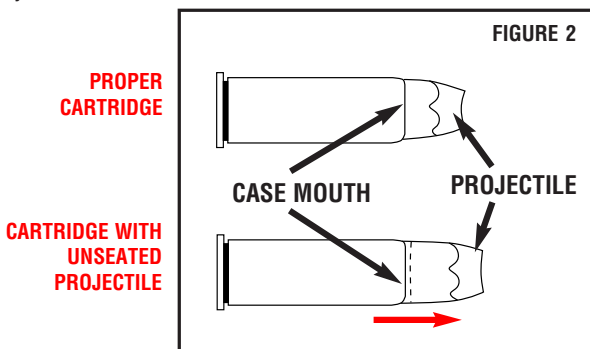

MODEL AND FEATURES IDENTIFICATION

The serial number and the model number appear inside the yoke (FIGURE 3) when the cylinder is in the open position.

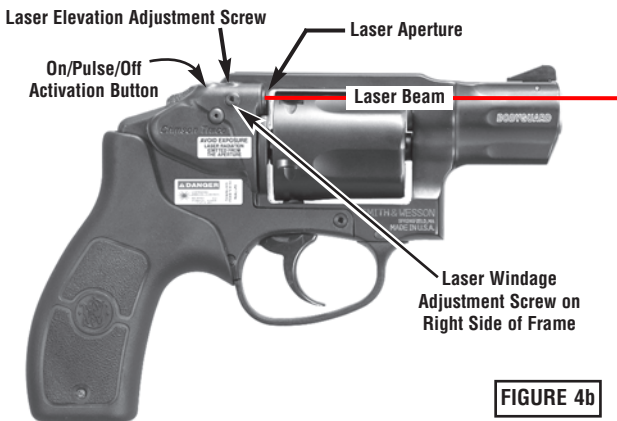
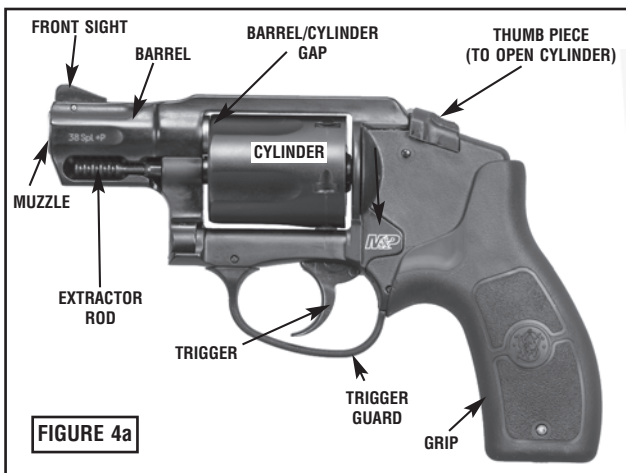
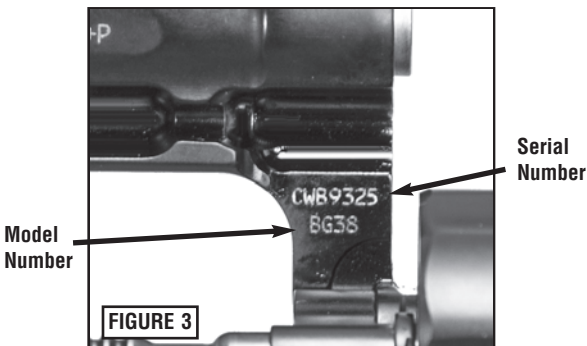

INSPECTING YOUR REVOLVER



WARNING: ALWAYS ENSURE THAT THE FIREARM IS UNLOADED BEFORE INSPECTING.



When you inspect your revolver, you must first check for yourself to ensure that it is unloaded. Do this with your finger off the trigger and out of the trigger guard (FIGURE 5) and keep the barrel of the firearm pointed in a safe direction. Press the thumbpiece forward and push the cylinder to the left (FIGURE 6).

You must verify that all charge holes are free of live rounds and the barrel is free of any obstructions.

You must follow this procedure every time your revolver leaves your hand, is cleaned, handed to you or another person, transported or stored.



WARNING: NEVER RELY ON MECHANICAL FEATURES ALONE. ONLY YOUR SAFE GUN HANDLING WILL ENSURE THE SAFE USE OF YOUR FIREARM. THIS IS YOUR RESPONSIBILITY.

PREPARATION FOR FIRING



WARNING: THE FAILURE TO FOLLOW THESE FIREARM SAFETY REQUIREMENTS WILL CAUSE SERIOUS PERSONAL INJURY OR DEATH TO YOU OR OTHERS.

- **ALWAYS TREAT ALL FIREARMS AS IF THEY ARE LOADED.**
- **ALWAYS BE SURE THAT ALL CYLINDERS AND ACTIONS OF FIREARMS ARE OPEN, THAT CHAMBERS ARE CLEAR OF CARTRIDGES OR SHELLS, MAGAZINES ARE REMOVED OR UNLOADED, AND THAT FIREARMS ARE POINTING IN A SAFE DIRECTION.**
- **ALWAYS KEEP FINGERS AND OTHER PARTS OF YOUR BODY AWAY FROM THE MUZZLE, AWAY FROM THE GAP BETWEEN THE REVOLVER BARREL AND CYLINDER, AND AWAY FROM THE REVOLVER SLIDE AND EJECTION PORT.**
- **ALWAYS WEAR ADEQUATE AND PROPER EAR PROTECTORS SPECIFIED FOR FIREARM USE** to prevent permanent damage to your hearing. Make sure others who are nearby are wearing ear protection as well.
- **ALWAYS WEAR SAFETY GLASSES SPECIFIED FOR FIREARM USE**, whether indoors or out. Safety glasses should protect your eyes from the firing flash and particles associated with the discharge of ammunition. Failure to do so creates a risk of personal injury from particle or debris spitting or a ricochet.
- **ALWAYS BE ALERT AND ALWAYS FOLLOW THE SAFETY INSTRUCTIONS OF THE RANGE OFFICER.** Never shoot if you are tired, cold or impaired in any way.
- **ALWAYS BE AWARE OF OTHER PEOPLE** so that persons do not accidentally walk into the line of fire.
- **THE SHOOTER (AND ALL OTHERS IN THE SHOOTING AREA) MUST ALWAYS BE IN A POSITION THAT IS OUT OF THE LINE OF FIRE** and are not within an area where they may be struck by a ricochet or particles spitting from a firearm, or by ejected cases from some types of firearms.
- **NEVER SHOOT AT SURFACES THAT MAY CAUSE A RICOCHET.** Always select a place to shoot that has a safe backstop, is free from obstructions and has no surfaces which may cause a ricochet.
- **NEVER FIRE RANDOMLY INTO THE SKY.** Always select a place to shoot that has a safe backstop.
- **NEVER USE ALCOHOL OR DRUGS BEFORE OR WHILE SHOOTING OR HANDLING ANY FIREARM.**

LOADING



WARNING: ALWAYS KEEP THE MUZZLE POINTED IN A SAFE DIRECTION.

- Never load your revolver until you have read and fully understand this manual.
- Do not load the revolver until you are ready to use it. Keep your finger off the trigger and outside the trigger guard until you are ready to fire.
- Never load your revolver until you are at the shooting site and fully prepared to fire.
- To load your revolver, hold it in one hand with the muzzle pointed in a safe direction and away from you and others.
- Keep your finger off the trigger and out of the trigger guard.

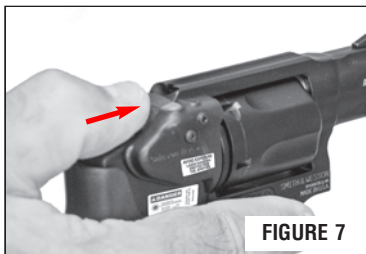

- Press the thumbpiece forward to unlock the cylinder (FIGURE 7).
- Push the cylinder to the left (FIGURE 8) and place a round of the correct ammunition in each charge hole.

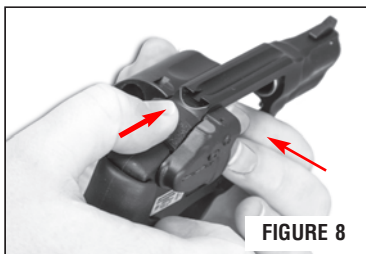

- Grasp the revolver in the shooting hand with your finger still outside the trigger guard (FIGURE 9).
- Push the cylinder back into the frame until it locks into place.

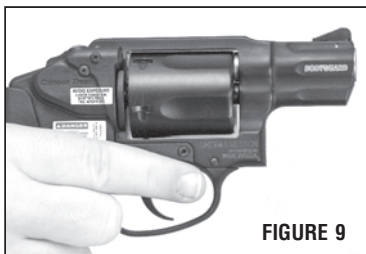

Your revolver is now fully loaded and ready to fire when the trigger is pulled.



WARNING: THE REVOLVER WILL FIRE IF THE TRIGGER IS PULLED!



WARNING: ALWAYS INSPECT YOUR REVOLVER VISUALLY TO BE SURE THE TRIGGER IS IN THE AT REST OR FORWARD POSITION BEFORE HOLSTERING OR CARRYING IT. REMEMBER TO KEEP YOUR REVOLVER POINTED IN A SAFE DIRECTION. NEVER LEAVE A LOADED FIREARM UNATTENDED.

FIRING



WARNING: ALWAYS KEEP THE MUZZLE POINTED IN A SAFE DIRECTION.



WARNING: WEAR EYE AND EAR PROTECTION SPECIFIED FOR FIREARM USE EVERY TIME YOU DISCHARGE YOUR FIREARM. MAKE SURE OTHERS IN THE VICINITY OF WHERE YOU WILL BE SHOOTING DO SO AS WELL.



WARNING: ALWAYS KEEP YOUR FINGERS AWAY FROM THE AREA BETWEEN THE CYLINDER AND THE BARREL DURING FIRING. PARTICLES AND HOT GAS WILL BE FORCED OUT FROM BETWEEN THE BARREL AND CYLINDER IN ANY REVOLVER DURING NORMAL USE. FAILURE TO FOLLOW THIS WARNING WILL CAUSE SERIOUS PERSONAL INJURY.

- Always use the proper grip as shown for a two-hand hold (FIGURES 10 & 11). This keeps hands and fingers away from the barrel/cylinder gap.

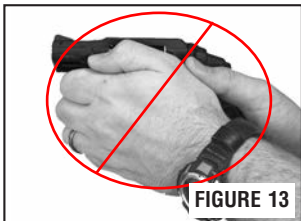
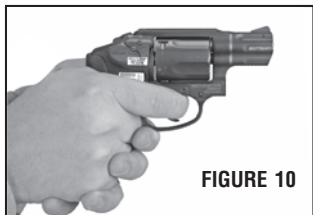

- Never allow hands or fingers to extend beyond the front of the cylinder when firing (FIGURES 12 & 13). This is an improper hold for any revolver.

The M&P® Bodyguard® 38 is a double action only mechanism, wherein the shooter fully pulls the trigger to the rear, causing the internal hammer to fully cycle rearward, the cylinder to turn and then the internal hammer to release - firing the cartridge. There is no external hammer spur. This revolver cannot be fired in single action mode by manually cocking the hammer.

- Never touch the trigger until you are ready to fire.

FIRING CONT'D

- To fire the handgun, pull the trigger fully to the rear. The internal hammer will move rearward and then fall forward to fire the revolver. After firing, you must allow the trigger to move forward fully before you can fire another shot. Failure to do so will prevent the lockwork from fully cycling and will prevent you from being able to fire the next shot.
- Keep your finger off the trigger and outside the trigger guard until you are ready to fire again.
- It has come to our attention that some users of Smith & Wesson handguns may stage the trigger in anticipation of firing a shot. Staging is the act of pulling the trigger rearward toward — stopping just short of — the point where the internal hammer falls and the handgun fires. Such manipulation of the trigger can reduce the user's control of the handgun and can result in an unintentional discharge. Furthermore if the user decides not to fire, release of the trigger from a position close to the firing point in the staging process could result in an unintended discharge.

 **WARNING: "STAGING" THE TRIGGER VIOLATES A BASIC RULE OF FIREARM SAFETY WHICH WARNS YOU TO KEEP YOUR FINGER OUT OF THE TRIGGER GUARD UNTIL YOU HAVE MADE THE COMMITMENT TO FIRE. "STAGING" CREATES A SERIOUS RISK OF PERSONAL INJURY OR DEATH SINCE IT MAY LEAD TO AN UNINTENTIONAL DISCHARGE.**

CLEARING MISFIRES

 **WARNING: IF YOUR HANDGUN GIVES ANY INDICATION THAT IT IS NOT PERFORMING PROPERLY OR THE OPERATION OF YOUR HANDGUN HAS CHANGED "THE WAY IT FEELS OR SOUNDS", STOP FIRING. MAKE SURE THE FIREARM IS POINTED IN A SAFE DIRECTION, UNLOAD THE FIREARM AND HAVE IT INSPECTED AND TEST-FIRED BY A GUNSMITH QUALIFIED TO PERFORM SERVICE ON SMITH & WESSON FIREARMS.**

- If a cartridge fails to fire, wait ten seconds while keeping the muzzle pointed in a safe direction.
- Keep your finger off the trigger and out of the trigger guard.
- Press and hold the thumbpiece forward and swing the cylinder to the left.
- Remove the defective cartridge and dispose of it in a method specifically approved for live round disposal.

UNLOADING



WARNING: ALWAYS KEEP YOUR REVOLVER POINTED IN A SAFE DIRECTION. ALWAYS KEEP YOUR FINGER OFF THE TRIGGER AND OUTSIDE THE TRIGGER GUARD WHEN UNLOADING.

- Point the muzzle in a safe direction. Make sure your finger is off the trigger and the trigger is in the “at rest” or forward position (FIGURE 14).

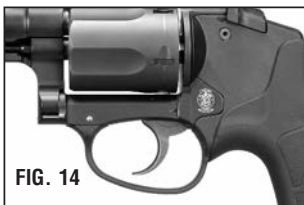

- The trigger must be fully forward with no finger pressure on it to allow the cylinder to be unlocked and opened (FIGURE 15).



- To remove either live cartridges or spent casings from the cylinder, first point the barrel in a safe direction. Press the thumb-piece forward and swing and hold the cylinder fully to the left (FIGURE 16).



- With the barrel pointing upward in a safe direction, press the extractor rod down and remove all cartridges or casings from the cylinder (FIGURE 17).



- Make a visual check to be sure all charge holes (chambers) are empty (FIGURE 18).

- Safely secure and store ammunition separately from your firearm after unloading.

- Be sure to safely secure the firearm when you are finished using it.



GUNSMITH ADVISORY

FOR USE BY TRAINED GUNSMITHS ONLY

CAUTION:

The barrel shroud and frame are one piece of material on the M&P® Bodyguard® 38.

NO attempt should ever be made to remove the Barrel Assembly with a standard barrel wrench. To do so will destroy the barrel shroud/frame of your revolver. As the accompanying drawing (FIGURE 19) shows, the barrel shroud is part of the frame. The stainless steel barrel tube must only be removed by a qualified gunsmith using a special tool available from Smith & Wesson. The barrel assembly is re-installed using the same tool and an accurate torque wrench.

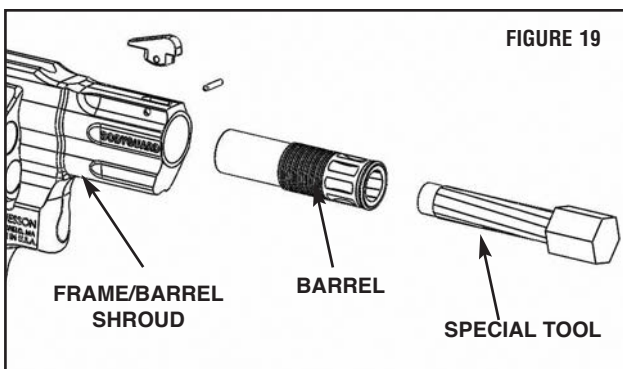

CLEANING AND MAINTENANCE

WARNING: ENSURE THAT YOUR FIREARM IS UNLOADED BEFORE BEGINNING TO CLEAN IT. (SEE "INSPECTING YOUR FIREARM" SECTION). ALWAYS FOLLOW THE RULES OF SAFE GUN HANDLING.

WARNING: WEAR SAFETY GLASSES EVERY TIME YOU ASSEMBLE OR DISASSEMBLE YOUR FIREARM AND ATTEMPT CLEANING OR MAINTENANCE.

- Before using your firearm for the first time, it should be cleaned.
- Your firearm was treated at the factory with either a preservative or oil to protect it against corrosion during shipping and storage.

CLEANING & MAINTENANCE CONT'D

- Preservative and oil should be wiped from the bore, chamber and exposed areas using a clean swab or patch before using the firearm.

CAUTION: Never disassemble your firearm beyond the instructions in the Field Stripping and Inspection sections of this manual.

- Purchase cleaning supplies from your firearms dealer that are specifically designated for your type and caliber of firearm. Many suppliers offer these in kit form for your convenience.
- Follow the instructions provided with your cleaning supplies.

NOTE: A basic firearm cleaning kit should include: a brass bore brush and a cleaning jag of appropriate size for the bore being cleaned, high-quality gun cleaning solvent and gun oil/lubricant, cotton cleaning patches and a cleaning rod that is long enough to push the brush and jag completely through the barrel.

- Remove excessive firing residue from the bore and chamber using a properly fitted brass brush dipped in gun cleaning solvent. Finish the bore cleaning process by running a dry cotton cloth patch through the bore to remove residue and solvent.
- Clean the exterior of the firearm using a non-abrasive cleaning cloth.
- After cleaning, lightly coat the metal parts, internal and external with a high quality gun oil. Refer to the "Lubrication" section in this manual for instructions on lubricating the firearm.

Whenever your firearm has been exposed to sand, dust, extreme humidity, water or other adverse conditions, it must be cleaned and lubricated.



WARNING: ALWAYS HAVE ADEQUATE VENTILATION. CLEANING FIREARMS IN POORLY VENTILATED AREAS, DISCHARGING FIREARMS, OR HANDLING AMMUNITION MAY RESULT IN EXPOSURE TO LEAD AND OTHER SUBSTANCES KNOWN TO CAUSE BIRTH DEFECTS, REPRODUCTIVE HARM, AND OTHER SERIOUS PHYSICAL INJURY. WASH HANDS THOROUGHLY AFTER EXPOSURE.

CAUTION: Always follow the instructions provided with your gun cleaner and gun lubricant.

CAUTION: Some cleaners can cause damage to your firearms. You should avoid prolonged solvent immersion and avoid any ultrasonic cleaning of your firearm. Choice of solvent should be restricted to those products specifically developed for firearms maintenance. Damage to a firearm's finish may occur if these cautions are ignored. Ammoniated solvents or other strong alkaline solvents, should not be used on any Smith & Wesson firearm.

CLEANING & MAINTENANCE CONT'D

Cleaning is essential to ensure the proper functioning of your firearm.

Your firearm is a precision instrument. To ensure reliable function it is necessary to follow a routine maintenance procedure. After firing your firearm, be sure to unload it following the procedure outlined in the section entitled "Inspecting Your Firearm" before performing any cleaning or maintenance procedure.

Remove any gun cleaning solution, oil and fingerprints from the outside surfaces of the firearm. (Finger moisture, if left, could start a corrosion process.)



WARNING: NEVER MANIPULATE, ADJUST OR CHANGE ANY OF THE INTERNAL COMPONENTS OF YOUR FIREARM UNLESS SPECIFICALLY DIRECTED TO DO SO IN THIS MANUAL. IMPROPER MANIPULATION OF ANY INTERNAL COMPONENT MAY AFFECT THE SAFETY AND RELIABILITY OF YOUR FIREARM AND MAY CAUSE SERIOUS INJURY OR DEATH.



WARNING: ANY MAINTENANCE OR SERVICE NOT SPECIFIED IN THIS MANUAL MUST BE PERFORMED BY A QUALIFIED GUNSMITH USING GENUINE SMITH & WESSON PARTS. IF YOU DO OTHERWISE, IMPROPER FUNCTIONING OF YOUR FIREARM MAY OCCUR AND SERIOUS INJURY OR DEATH MAY RESULT.

If your firearm will be used in a cold climate, be sure to use an oil of an appropriate weight so that it will not congeal in cold temperatures, causing the interaction of important parts to be slowed or halted.

MAINTENANCE BEFORE STORAGE

When storing, do not encase your firearm in anything that will attract or hold moisture, for example, leather or heavy cloth. Also, do not store guns with a plug inserted in the barrel for this can be a contributing factor to moisture accumulation. If your firearm is to be stored for an extended period, the bore, chambers and internal working mechanism should be oiled with a high quality lubricating oil or preservative intended for firearms. The external working mechanisms and barrel should be coated with an anti-rust oil. Before using your firearm again, be sure to clean it. Every time you clean your firearm, check it for signs of wear. If excessive wear is noted, do not use the firearm. Return it to Smith & Wesson for service or have it checked by a qualified gunsmith.

LIMITED WARRANTY FOR THE M&P® BODY- GUARD® 38 REVOLVER

For Owners Within The United States.

This warranty is granted by Smith & Wesson Corp. This warranty is effective from the date of purchase and applies to the original owner of any firearm. With respect to such firearms, this warranty supersedes any and all other warranties.

Smith & Wesson firearms are warranted to be free from defects in material and workmanship. Any such defects of which Smith & Wesson receives written notice within one year from the date of purchase by the original owner, will be remedied by Smith & Wesson without charge within a reasonable time after such notification and delivery of the firearm as provided below.

In the event of an emergency (repairs needed by law enforcement, an upcoming match or hunting trip), call 1-800-331-0852, ext. 4125 and ask for 911 Priority Repair Service. This allows you to speak with a Smith & Wesson representative. Immediately upon receipt, your firearm will be assigned to a gunsmith. After the work is completed, we will return your Smith & Wesson firearm via overnight delivery.

Warranty claims (in writing) and the firearm concerned should be delivered to Smith & Wesson's Customer Service Department, 2100 Roosevelt Avenue, Springfield, Massachusetts 01104. In addition, a copy of the bill of sale in the owner's name, or a copy of ATF Form 4473 indicating date of purchase must be included. It is important that the owner comply with all applicable federal, state and local laws and regulations in the shipment of firearms to Smith & Wesson.

NOTE: See the Contact & Shipping section of this manual for further details regarding returns.

Warranty claims should state the model and serial number of the firearm concerned and the description of the difficulty experienced. It is recommended that shipments be insured by the owner, since Smith & Wesson will accept no responsibility for loss or damage in transit. Transportation and insurance charges for return to owner will be paid by Smith & Wesson if the claim is covered by the warranty.

UNDER NO CIRCUMSTANCES SHALL SMITH & WESSON BE RESPONSIBLE FOR INCIDENTAL OR CONSEQUENTIAL DAMAGES WITH RESPECT TO ECONOMIC LOSS, INJURY, DEATH OR PROPERTY DAMAGE, WHETHER AS A RESULT OF BREACH OF THIS WARRANTY, NEGLIGENCE OR OTHERWISE.

LIMITED WARRANTY CONT'D

Some States do not allow the exclusion or limitation of incidental or consequential damages, so the above limitation or exclusion may not apply to you.

Smith & Wesson will not be responsible for:

- Defects or malfunctions resulting from careless handling, unauthorized adjustments or modifications made or attempted by anyone other than a qualified gunsmith following Smith & Wesson authorized procedures, the use or installation of any unauthorized parts or accessories on the firearm, or failure to follow the disassembly instructions in the Smith & Wesson manual.
- Use of defective or improper ammunition, corrosion, neglect, abuse, ordinary wear and tear, or unreasonable use.
- Criminal misuse, negligence or use under the influence of drugs or alcohol.

Smith & Wesson's Lifetime Service Policy begins after the warranty period has expired. Smith & Wesson will repair, without charge, for the lifetime of the original owner, any Smith & Wesson handgun purchased on or after February 1, 1989, and any M&P15 series rifle, that is found to have a defect in material or workmanship. Eligibility for this Lifetime Service Policy requires returning the Product Registration Card within 30 days of purchase. The Lifetime Service Policy covers functional defects; it does not include the firearm's finish, grips, magazines or sights. The Lifetime Service Policy is in addition to and not an extension of the Smith & Wesson Warranty.

This warranty gives you specific legal rights. You may also have other rights that vary from State to State.

NOTE: All liability is excluded in the event that the instructions in the Smith & Wesson manual are not observed.

CONTACT & SHIPPING INFORMATION

For Owners Within The United States

NOTE: A Return Merchandise Authorization (**RMA**) is the first step in the process of returning a product in order to receive a repair, replacement or refund. Please contact Smith & Wesson's Customer Service Dept. (via e-mail: qa@smith-wesson.com or by phone at 800-331-0852 ext. 4125) to obtain authorization to return your firearm so we can process it quickly and efficiently. The RMA number that is supplied by Smith & Wesson must be displayed on the outside of the returned product's packaging; returns without an RMA number will be routed differently which will result in delayed processing.

The issuance of an Return Merchandise Authorization (**RMA**) allows Smith & Wesson an opportunity to try to diagnose and correct a customer's concerns with the product (such as ammunition problems) before it is returned. Accordingly, please contact us before returning your Smith & Wesson firearm.

STEP 1: CONTACT CUSTOMER SERVICE

Tel: 800-331-0852 • 413-781-8300 ext. 4125

E-mail: qa@smith-wesson.com

STEP 2: RETURNS - FOR SERVICE

SEND ALL FIREARMS TO:

Smith & Wesson

2100 Roosevelt Avenue • Springfield, MA 01104

Should your Smith & Wesson firearm require service, it should be returned to the Smith & Wesson factory.

- Call or e-mail the Customer Service Dept. for authorization and shipping instructions.
- Ensure that the firearm is unloaded.
- **Do not attempt to ship a firearm via US Postal Service; only federally licensed dealers may ship a firearm by US Postal Service.**
- **DO NOT SHIP ANY AMMUNITION.**

CONTACT & SHIPPING CONT'D

- Enclose a letter which includes your full name and address (no P.O. Boxes, please), daytime telephone number, e-mail address, the serial number of the firearm, and details of the problem experienced (stating the brand and type of ammunition used when the problem occurred) or work desired.
- Record the serial number before shipping, in case you wish to check on the repair status of your firearm.
- Please remove all custom parts and accessories, such as stocks, special sights and scopes, or slings from your firearm before returning.
- Place the firearm in its original case or in a similarly secure container and pack it securely.
- The package must **NOT** bear any markings which indicate the identity of the contents.
- It is most important that you comply with federal, state, and local laws and regulations. The following guidelines are meant to help, but you must seek assistance from the appropriate authorities if necessary.
- If your firearm must be replaced, it may be necessary to ship the replacement to a dealer rather than directly to you. You will be requested to furnish a signed FFL (Federal Firearms License) from your dealer in such an instance.
- Warranty repair work will begin upon receipt and examination of the firearm. In the case of repairs or work not covered by the warranty, a quotation covering the cost of the work plus round trip transportation charges will be sent to you. Repairs or modification will be scheduled upon receipt of payment.
- A parts list can be obtained by contacting Smith & Wesson Customer Service.



WARNING: YOU MAY PURCHASE ACCESSORIES FOR YOUR SMITH & WESSON FIREARM. YOU MUST HAVE SOME OF THESE PARTS INSTALLED BY A GUNSMITH QUALIFIED TO PERFORM SERVICE ON SMITH & WESSON FIREARMS. YOU MUST NEVER ATTEMPT TO MODIFY YOUR FIREARM OR INSTALL REPLACEMENT PARTS IN YOUR FIREARM. ALWAYS USE A QUALIFIED SMITH & WESSON GUNSMITH EVEN IF THE REPAIR SEEMS TO BE SIMPLE.

CUSTOM SERVICE

We understand that Smith & Wesson gun owners may want to enhance their guns with custom gunsmithing, refinishing or accessories. Our gunsmiths offer specialized services and exclusive products to enhance your shooting experience.

Accessories for your Smith & Wesson firearm are available from your local Smith & Wesson Stocking Dealer, or directly from Smith & Wesson.

Contact the Customer Service Department at 1-800-331-0852, ext. 2905 for information about these services.

When ordering directly from the factory, please provide the following information:

- Model Number
- Dash Number
- Serial Number
- Approximate date of purchase
- Complete Return Address
- VISA/Discover/MasterCard Number & Expiration Date
- For Foreign Orders Only, Fax Number or E-mail Address

This handgun is not equipped with a device that fully blocks use by unauthorized users. More than 200,000 firearms like this one are stolen from their owners every year in the United States. In addition, there are more than a thousand suicides each year by younger children and teenagers who get access to firearms. Hundreds more die from accidental discharge. It is likely that many more children sustain serious wounds or inflict such wounds accidentally on others. In order to limit the chance of such misuse, it is imperative that you keep this firearm locked in a secure place and take other steps necessary to limit the possibility of theft or accident. Failure to take reasonable preventative steps may result in innocent lives being lost, and in some circumstances may result in your liability for these deaths.

The certification below is required only for handguns sold in the United States with a barrel length shorter than 3”.

Smith & Wesson Corp. hereby certifies average accuracy test results for all new handguns with a barrel shorter than 3” as follows:

7 yards	14 yards	21 yards
1.7”	3.9”	6.3”

This certification is based on tests conducted by Smith & Wesson Corp. using a fixed handgun, rest and firing ammunition manufactured by a member of the Shooting Arms and Ammunition Manufacturers Institute (SAAMI) as defined in ANSI/SAAMI Z299.3-1993.

This certification represents actual tests based on several handguns, selected at random. Your particular handgun may have accuracy better than the results stated in this certification.

WARRANTY CENTERS

NOTE: Addresses and other contact information for Warranty Centers are available on the Smith & Wesson website at www.smith-wesson.com or by calling Customer Service toll-free at 1-800-331-0852 ext 4125.

APPENDIX “A” CRIMSON TRACE® LASER

**OPERATOR MANUAL FOR THE LX-381 INTEGRATED
CRIMSON TRACE® LASER ON THE
M&P® BODYGUARD® 38 REVOLVER**



WARNING: ALWAYS KEEP YOUR FIREARM POINTED IN A SAFE DIRECTION. ALWAYS TREAT EVERY FIREARM AS IF IT IS LOADED AND WILL FIRE. DO NOT TAKE ANYONE’S WORD THAT THE FIREARM IS UNLOADED – ALWAYS CHECK FOR YOURSELF.



WARNING: ENSURE THAT YOUR FIREARM IS UNLOADED BEFORE ATTEMPTING ANY ADJUSTMENT, CLEANING OR MAINTENANCE TO THE CRIMSON TRACE® LASER. ALWAYS FOLLOW THE RULES OF SAFE GUN HANDLING.

CRIMSON TRACE® LASER OPERATION

This appendix is intended for use by operators of the M&P® BODYGUARD® 38 revolver Integrated Crimson Trace® Laser (when the revolver is so-equipped). It provides a system description, operational procedures, and maintenance responsibilities. Complete familiarization with this manual prior to using the equipment will ensure safe operation and maximum effectiveness of the Crimson Trace® Laser.

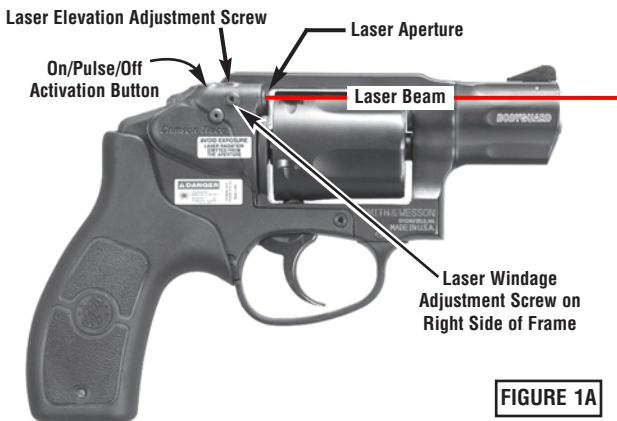

FIGURE 1A

MODEL NUMBER & EQUIPMENT NAME: LX-381
M&P® BODYGUARD® 38 REVOLVER
Integrated Crimson Trace® Laser
MANUFACTURER: Crimson Trace Corporation
9780 SW Freeman Dr., Wilsonville, OR 97070 USA
Tel: (800) 442-2406 Fax: (503) 783-5334
crimsontrace.com

PURPOSE OF EQUIPMENT: The Crimson Trace® Laser is a FDA Class IIIa (IEC Class 3R) Laser Product that emits visible light for precise aiming of the M&P® BODYGUARD® 38 revolver.

The Crimson Trace® Laser provides for quick and accurate target acquisition in low light and close quarters situations and features ambidextrous laser controls, three operating modes, and a five minute auto-off timer.

CRIMSON TRACE® LASER BATTERIES



WARNING: DO NOT USE THE CRIMSON TRACE® LASER WITH A MIX OF OLD AND NEW BATTERIES, OR BATTERIES OF DIFFERENT BRANDS – RISK OF FIRE, EXPLOSION AND BURNS.

CAUTION: Do not store the Crimson Trace® Laser with the batteries installed for extended periods of time without testing periodically during such periods of non-use to ensure that it is functioning properly. When anticipating use of and reliance upon the Crimson Trace® Laser, check beforehand to ensure it is in proper working order.

Battery Inspection: The Crimson Trace® Laser is powered by two (2) 357 silver oxide batteries (or equivalent). Before installation, inspect the batteries for any cracks, dents, leakage, or bulging. Never install a defective battery in the Crimson Trace® Laser.

NOTE: Replacing batteries once a year is recommended. Any battery has the potential to leak harmful chemicals that can damage skin, clothing, or the inside of the Crimson Trace® Laser. To avoid risk of injury, the following safety precautions apply when handling, storing, or disposing of batteries:

- Do not short circuit, puncture, incinerate, or disassemble.
- Do not attempt to recharge the batteries.
- Prior to use, inspect all batteries for cracks, dents, leakage, or bulging. Never install a defective battery in the Crimson Trace® Laser.

Performance of the batteries will vary depending on actual environmental conditions. Check beforehand to ensure that the laser is in proper working order.

NOTE: Proper functioning of the Crimson Trace® Laser is dependent upon fully charged batteries. Batteries typically last 4 hours of actual “ON” time under normal intermittent use. If the laser becomes dim or fades, replace the batteries.

NOTE: Dispose of all depleted batteries in accordance with applicable federal, state, and local environmental regulations.

CRIMSON TRACE® LASER SAFETY PRECAUTIONS



WARNING: VISIBLE LASER RADIATION EMITS FROM THE CRIMSON TRACE® LASER WHILE IN OPERATION – AVOID DIRECT EYE EXPOSURE.

- DO NOT STARE INTO THE LASER BEAM.
- DO NOT LOOK INTO THE LASER BEAM THROUGH BINOCULARS OR TELESCOPES.
- DO NOT POINT THE LASER BEAM AT MIRROR-LIKE SURFACES.
- DO NOT SHINE THE LASER BEAM INTO ANOTHER INDIVIDUAL'S EYES.

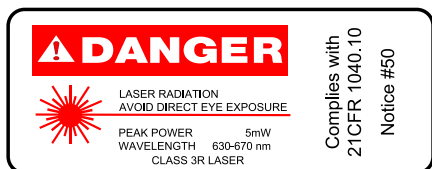

PRODUCT SPECIFICATIONS:

- BEAM INTENSITY: 5mW peak, Class 3R laser
- DOT SIZE: Approximately 0.5 inches diameter at 50 feet
- BATTERIES: Two (2) 357 silver oxide batteries; over 4 hours of continuous on time
- ACTIVATION: Instant Activation - on/pulse/off activation-button with auto shut off at five minutes
- WARRANTY: One-year limited warranty
- This product complies with 21 CFR 1040.10



WARNING: DO NOT USE THE CRIMSON TRACE® LASER IN ENVIRONMENTS CONTAINING AN EXPLOSIVE ATMOSPHERE OR IN AREAS WHERE GASOLINE, PAINTS, SOLVENTS, OR OTHER FLAMMABLE LIQUIDS ARE STORED.

Before use, inspect all pieces of equipment for any damage such as cracks, loose parts, or other visible defects. If any damage or defects are noted:

CONTACT SMITH & WESSON CUSTOMER SERVICE

Tel: 800-331-0852 • 413-781-8300 ext. 2905
E-mail: qa@smith-wesson.com

RETURNS FOR SERVICE -

FOR ISSUES INVOLVING THE LASER SIGHTING DEVICE:

Smith & Wesson
Customer Service Department
2100 Roosevelt Avenue,
Springfield, Massachusetts 01104

REMOVE / INSTALL CRIMSON TRACE® LASER



WARNING: ENSURE YOUR FIREARM IS UNLOADED BEFORE ADJUSTMENT OF THE CRIMSON TRACE® LASER. AT ALL TIMES FOLLOW THE BASIC FIREARMS SAFETY RULES IN THE SECTION ENTITLED “YOUR SAFETY RESPONSIBILITIES”.

The Crimson Trace® Laser must be removed from the firearm before inspecting, cleaning, replacing batteries, or performing other maintenance functions.

- Loosen the captive hex screw completely by turning it counterclockwise as viewed from the side of the sight (FIGURE A2). This screw holds the Crimson Trace® Laser to the frame.



FIGURE A2

- After the hex screw is fully loosened, remove the Crimson Trace® laser from the frame by pulling it out and away from the frame of the M&P® BODY-GUARD® 38 revolver (FIGURE A3).

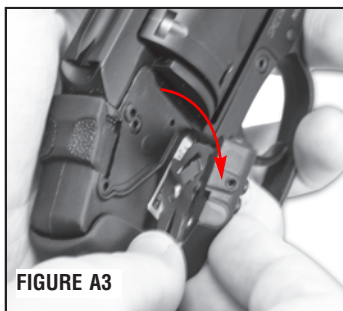
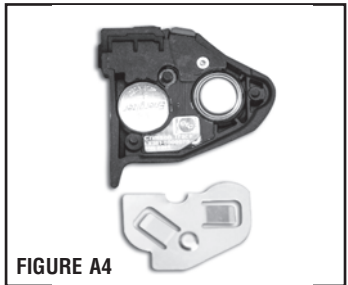

FIGURE A3

REMOVE / INSTALL CRIMSON TRACE® LASER CONTINUED

- Remove the Contact Cover from the back of the Crimson Trace® Laser housing to gain access to the batteries (FIGURE A4).



INSTALL THE Crimson Trace® LASER ONTO THE M&P® BODYGUARD® 38 REVOLVER.

- Install two (2) 357 silver oxide batteries as shown (FIGURE A4). Proper battery orientation is clearly marked on the battery pocket of the Crimson Trace® Laser.

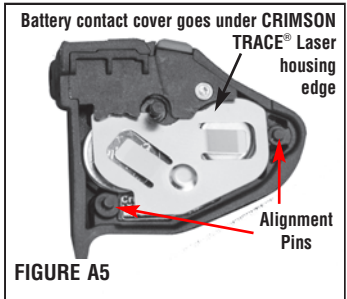

- Reinstall the battery contact cover by sliding it under the edges of the Crimson Trace® Laser housing as shown (FIGURE A5).

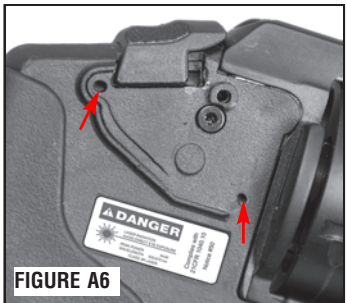

- Insert the Crimson Trace® Laser alignment pins (FIGURE A5) into the corresponding holes in the revolver's frame (FIGURE A6). Use the provided hex wrench to turn the hex screw in clockwise until snug. Make sure the Crimson Trace® Laser is secured and cannot move (FIGURE A7). Do not over-tighten the screw.



CRIMSON TRACE® LASER ACTIVATION BUTTON



WARNING: VISIBLE LASER RADIATION EMITS FROM THE CRIMSON TRACE® LASER WHILE IN OPERATION – AVOID DIRECT EYE EXPOSURE.

The activation-button to turn the laser on and off is located on the right side of the revolver (FIGURE A8).

The table below illustrates modes of operation for the Crimson Trace® Laser and the input required to activate them.



FIGURE A8

ON/PULSE/OFF ACTIVATION-BUTTON TABLE		
Activation-Button Behavior		
Mode	User Input	Result
On	Push-Button 1x	Constant Laser
Pulse	Push-Button 2x	Pulse Laser
Off	Push-Button 3x	Off

The Crimson Trace® Laser is equipped with a five minute auto-off timer. After five minutes (± 15 seconds) of continuous activation, the laser will begin to flash. This is true even if the Crimson Trace® Laser is being operated in Pulse Mode.

CRIMSON TRACE® LASER ADJUSTMENT & ZEROING



WARNING: ENSURE YOUR FIREARM IS UNLOADED BEFORE ADJUSTING YOUR SIGHT. AT ALL TIMES FOLLOW THE BASIC FIREARMS SAFETY RULES IN THE SECTION ENTITLED “YOUR SAFETY RESPONSIBILITIES”.



WARNING: VISIBLE LASER RADIATION EMITS FROM THE CRIMSON TRACE® LASER WHILE IT IS IN OPERATION – AVOID DIRECT EYE EXPOSURE.

The Crimson Trace® Laser is equipped with adjustment screws for independent movement of the laser beam for both windage and elevation. Adjustment screws can be turned using the provided hex wrench.

Laser Adjustment Table (below): This table shows the direction of adjuster rotation (as viewed from above and behind the firearm) and the resultant direction of the laser beam and the shot group movement.

LASER ADJUSTMENT TABLE			
Windage or Elevation	Adjustment Screw Rotation	Laser Beam Movement	Shot Group Movement
Windage Adjustment	Clockwise	Right	Left
	Counter-Clockwise	Left	Right
Elevation Adjustment	Clockwise	Up	Down
	Counter-Clockwise	Down	Up

ZEROING PROCEDURE

The Crimson Trace Laser is factory preset to be nearly parallel with the barrel of the firearm and is pre-sighted at 25'. It is ready to be zeroed at any distance via live fire.



WARNING: ALWAYS BE SURE OF YOUR TARGET AND WHAT IS BEYOND IT WHEN FIRING.

CAUTION: One complete rotation of the adjustment screws in either direction provides ample beam movement for zeroing purposes. Turning the adjustment screws more than one complete rotation in either direction may result in damage to the Crimson Trace® Laser.

NOTE: Direct sunlight may hinder the ability of the user to effectively see the laser beam on the target.

- Mount a target with a clearly visible aiming point downrange at the desired zeroing distance.
- Turn ON the Crimson Trace® Laser by pressing the activation-button once.

LASER ADJUSTMENT & ZEROING CONT'D

- While aiming the M&P® BODYGUARD® 38 revolver with its iron sights, rotate the adjustment screws as needed to superimpose the laser strike point over the M&P® BODYGUARD® 38 revolver's aiming point (FIGURE A9). To determine the required direction of rotation, refer to the Laser Adjustment Table on page 36.

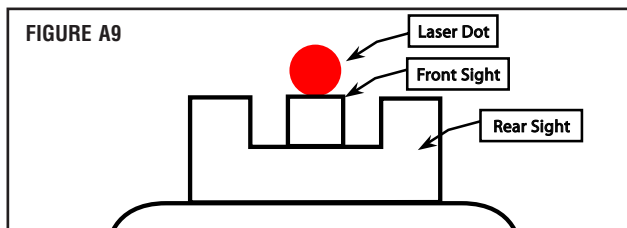

- Direct the Crimson Trace® Laser at the target aiming point.
- Fire a 3-round shot group and note the center of the shot group relative to the target aiming point.
- Rotate the adjustment screws (FIGURES A10 & A11) as needed to move the center of the shot group to the target aiming point. To determine the required direction of rotation, refer to the Shot Group Movement column in the Laser Adjustment Table on page 36.
- Fire another 3-round shot group to confirm zero.

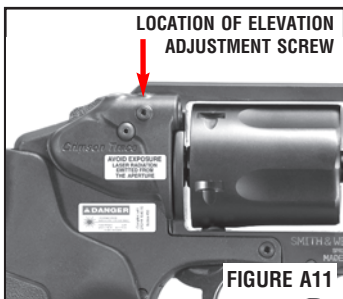

- Repeat these steps until the shot group falls within an acceptable radius around the target aim point.

The Crimson Trace® Laser is now zeroed to the M&P® BODYGUARD® 38 revolver. Press the activation-button twice to turn the laser OFF.

NOTE: As with any sighting device, the location of the shot group is dependent on distance to the target. A group that is shot using the laser aiming point at one distance will not necessarily be aligned with the aiming point at a different distance. The user needs to become familiar with the trajectory of the round being used and adjust accordingly.

CRIMSON TRACE® LASER MAINTENANCE



WARNING: ENSURE YOUR FIREARM IS UNLOADED BEFORE PERFORMING MAINTENANCE ON YOUR CRIMSON TRACE® LASER. AT ALL TIMES FOLLOW THE BASIC FIREARMS SAFETY RULES IN THE SECTION ENTITLED “YOUR SAFETY RESPONSIBILITIES”.

NOTE: Remove the Crimson Trace Laser from the M&P® BODY-GUARD® 38 before inspecting, cleaning or performing other maintenance functions.

The Crimson Trace® Laser should be inspected before each use and after prolonged periods of non-use. The following procedures will prolong the life of the laser and help ensure safe operation. Crimson Trace Laser sights require minimal attention and are designed to resist most common firearm chemicals and lubricants, however, excessive exposure to these chemicals can be detrimental. To ensure the safe and effective operation of your laser sights:

- Remove Laser Sight before cleaning gun.
- Do not use pressurized or compressed air.
- Do not immerse in cleaning fluid or lubricate firearm excessively. A firearm that has too much oil will foul the lens of the laser and result in an unfocused beam. This can be easily cleaned and causes no permanent damage.
- Do not allow cleaning solution to enter lens source.
- Do not allow solvents to contact your Laser that contain: VOCs or TCE such as: carburetor/brake cleaner, acetone, MEK, gasoline. Damage will result.
- Crimson Trace diodes are designed and positioned to minimize exposure. Occasional cleaning of the lens is recommended. After extensive shooting, you may notice a degradation of beam quality or “beam spread”. This is the result of fouling on the lens surface. This is normal and can be easily cleaned with the included cleaning swabs or a small cotton swab dipped in isopropyl alcohol or window cleaner.

Dry the lens with a clean dry swab. When cleaning the lens do not touch lens with any sharp objects.

Batteries: Inspect the batteries for cracks, dents, leakage or bulging. If a battery shows signs of damage, remove and dispose of properly. Replace batteries as required per battery handling section of this appendix.

Laser Aperture: The laser aperture may be cleaned using a soft cloth and water, alcohol or general purpose window cleaner. When cleaning the aperture do not touch with a sharp object that might scratch the surface.

CRIMSON TRACE® LASER LIMITED WARRANTY

Crimson Trace Corporation (CTC) warrants that the LX-381 Laser product on the M&P® BODYGUARD® 38 Revolver will be free from defects in materials and workmanship for a period of twelve (12) months from the date of purchase by the original owner. At its sole discretion, CTC will either repair or replace, at no charge, any LX-381 Laser product or part (with the exception of the batteries) which is found to be defective, under normal use and service, during the warranty period. CTC's obligation to either repair or replace shall be the owner's sole and exclusive remedy under this warranty. This warranty does not cover normal maintenance and service and does not apply to any products or parts that have been subject to modification, misuse, carelessness, accident, improper maintenance or repair other than by CTC.

This warranty also does not cover damage caused by faulty batteries. The battery manufacturer should be contacted in the event of a leak.

Warranty claims (in writing) and the Laser product concerned should be delivered to:

**Smith & Wesson
Customer Service Department
2100 Roosevelt Avenue,
Springfield, Massachusetts 01104**

Firearms cannot be shipped to Crimson Trace Corporation.

In addition, a copy of the bill of sale in the owner's name must be included. It is important that the owner comply with all applicable federal, state and local laws and regulations in the shipment of any firearm that is included with a Laser product.

Warranty claims should state the serial number (if any) of the Laser product and of the firearm included with the Laser product, and include a description of the difficulty experienced with the Laser product. It is recommended that shipments be insured by the owner, since neither CTC nor Smith & Wesson Corp. will accept any responsibility for loss or damage in transit.

This limited warranty extends only to the original owner of the LX-381 Laser product and there are no other warranties, expressed or implied other than as set forth in this limited warranty. CTC disclaims any warranties of merchantability and fitness for a particular purpose.

CRIMSON TRACE® LASER WARRANTY CONT'D

UNDER NO CIRCUMSTANCES SHALL CTC BE RESPONSIBLE FOR ANY INCIDENTAL, CONSEQUENTIAL OR SPECIAL DAMAGES ARISING OUT OF OR IN CONNECTION WITH PRODUCT USE OR PERFORMANCE, BREACH OF WARRANTY, NEGLIGENCE, OR OTHERWISE.

Some States do not allow the exclusion or limitation of incidental or consequential damages, so the above limitation or exclusion may not apply to you.

Note: All liability is excluded in the event that the instructions in this Appendix – “A” Operator Manual For The LX-381 Laser on the M&P® BODYGUARD® 38 revolver are not observed.

CRIMSON TRACE[®] LASER SERVICE & REPAIR

CONTACT SMITH & WESSON CUSTOMER SERVICE

Tel: 800-331-0852 • 413-781-8300 ext. 2905

E-mail: qa@smith-wesson.com

RETURNS FOR SERVICE - FOR ISSUES INVOLVING THE LASER SIGHTING DEVICE

Smith & Wesson
2100 Roosevelt Avenue
Springfield, MA 01104

Should your laser-equipped Smith & Wesson firearm require service specific to the laser device, it should be returned to the Smith & Wesson factory.

- Call or e-mail the Customer Service Dept. for authorization and shipping instructions.
- Ensure that the firearm is unloaded.
- **Do not attempt to ship a firearm via US Postal Service; only federally licensed dealers may ship a firearm by US Postal Service.**
- **DO NOT SHIP ANY AMMUNITION.**
- Enclose a letter which includes your full name and address (no P.O. Boxes, please), daytime telephone number, e-mail address, the serial number of the firearm, and details of the problem experienced (stating the brand and type of ammunition used when the problem occurred) or work desired.
- Record the serial number before shipping, in case you wish to check on the repair status of your firearm.
- Please remove all custom parts and accessories, such as stocks, special sights and scopes, or slings from your firearm before returning.
- Place the firearm in its original case or in a similarly secure container and pack it securely.
- The package must **NOT** bear any markings which indicate the identity of the contents.

CRIMSON TRACE® LASER LEGAL INFORMATION

The exportation of this product falls under the jurisdiction of the U.S. Commerce Department Bureau of Industry and Security and is subject to the Export Administration Regulations.

The LX-381 Laser is designed and produced by:

Crimson Trace Corporation, Wilsonville, Oregon, USA
www.crimsontrace.com



WARNING: THIS PRODUCT CONTAINS CHEMICALS KNOWN TO THE STATE OF CALIFORNIA TO CAUSE CANCER, OR BIRTH DEFECTS OR OTHER REPRODUCTIVE HARM.

Crimson Trace® holds several patents and may have other patents pending that cover its innovations. Please review individual products for patent numbers to determine the specific patent coverage.

Crimson Trace® trademarks are property of Crimson Trace Corporation, Portland, Oregon, and are used by permission

NOTES

NOTES

PATENT INFORMATION

This product may be covered by one or more patents. Visit www.smith-wesson.com for virtual patent information under the ***Resources*** tab.

Smith & Wesson®
2100 Roosevelt Avenue • Springfield, MA 01104
www.smith-wesson.com

P/N 3001410

REV:M&P® BODYGUARD38_042015