

UNIT

INSTRUCTION MANUAL

Model #: STC-U840IRS1

Toll Free 1-877-269-8490

WWW.STEALTHCAM.COM

Version 7.0_1628

03/2012

**** IMPORTANT NOTE ****

First, congratulations on purchasing one of the finest scouting cameras on the market today. We appreciate your business and want to prove to you we are committed to providing you the best product and support in the field.

By giving our customers a new state of the art web interface, which provides you with video tutorials and instruction on how to use the product in the most effective way.

TECHNICAL SUPPORT

EMAIL: stealthcam@gsmorg.com

Please allow 48hrs for response.

Stealth Cam, LLC

P.O. Box 539504

Grand Prairie, TX 75053-9504

CUSTOMER SERVICE

CONTACT & HOURS

Toll Free: 1-877-269-8490

Call Center Hours:

Mon - Fri / 8 AM – 6 PM (CST)

www.stealthcam.com

Stealth Cam Limited Warranty

Your Stealth Cam scouting camera is covered by a One Year Limited Warranty on parts and labor from the date of original purchase, and purchases must be made through an authorized dealer. The warranty covers defects in workmanship and materials. The warranty does not apply to units, which have been damaged or abused intentionally or unintentionally. A purchase from individuals or unauthorized internet sites such as eBay voids the warranty.

Tampering with or altering the unit will void the warranty. Any unauthorized service will void warranty. A copy of your original sales receipt must be produced for any warranty service and a Return Authorization (RA) number must be obtained from customer service at 877-269-8490 prior to returning product.

WWW.STEALTHCAM.COM
Toll Free 877-269-8490

**** IMPORTANT NOTE ****

TRIAD equipped cameras include FREE Image Scan Software download at: www.stealthcam.net/sc_image_scan.html

Stealth Cam Image Scan provides sophisticated motion searches based on targeted zones within a selected series of time-lapse images. Additional features include:

- Watch days of video in minutes with variable speed playback
- Import Time Lapse Photo sets from SD card to your computer
- Open existing Time Lapse Photo sets on your computer
- Process Photo Sets into high speed motion video
- Quickly jog through the time lapse frames, forwards and backwards
- Step frame forwards and backwards
- Create videos that you can watch, email or upload

To ensure optimum performance; your Stealth Cam (Wildview) camera may be eligible for periodical free software updates.

Please check http://stealthcam.net/sc_downloads_d.html for the latest firmware downloads & sign up for our weekly newsletter to stay informed on updates & new product news.

TABLE OF CONTENTS

Camera overview	5
Camera Kit contents	8
General Information	9
Quick Start Guide	10
Battery and Memory Installation	11
Setup and Programming	14
Using the Camera in PIR detection mode	27
Using the Camera in Time Lapse mode	28
Viewing & Deleting Files	29
Memory Compatibility chart	35
Technical Specifications	36
Image Capacity chart	37
Moon Phase chart	39
Frequently Asked Questions (FAQs)	40
FCC Compliance	42

CAMERA OVERVIEW

Front

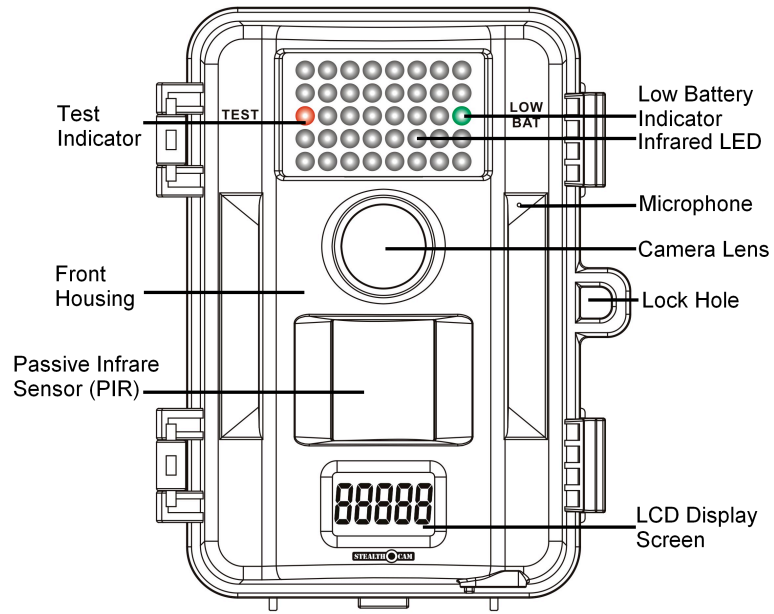

Inside

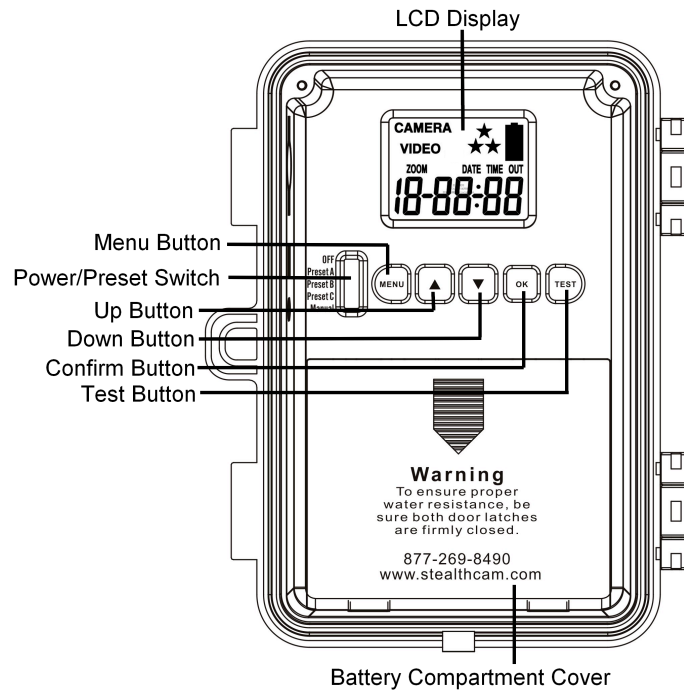

Side & Bottom view

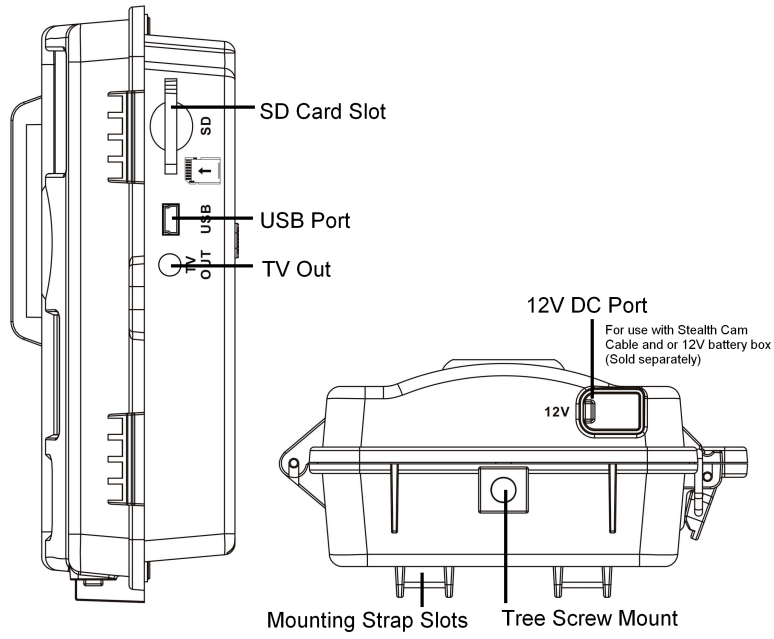

CAMERA KIT CONTENT

- Model STC-U840IRS1 Digital Scouting Camera
- User manual
- Strap

GENERAL INFORMATION

Storing conditions

- Operating Environment: 14 to 104 deg F (-10 to 40 deg C). 20-85% relative humidity, non-condensing.

Special care instructions!!

- The camera is designed to be weather resistant. Never attempt to immerse the unit in water or any other liquid. This will damage the unit and void the warranty.
- Use a soft lens cloth for cleaning lens. Avoid touching lens with fingers.
- Remove dirt or stains with a soft cloth dampened with water or neutral detergent. Keep your camera in a dry and cool dust-free environment or container when it is NOT used.
- Take the batteries out, when camera is NOT to be used over an extended period of time.
- Avoid dropping your camera on to a hard surface.
- Do not disassemble your camera.
- Do not mix new and old batteries.
- Do not open the camera for unauthorized service. This could cause serious damage to the unit and WILL void the warranty.

NOTE: This camera is a precision electronic device. Do not attempt to service this camera yourself, as opening or removing covers may expose you to dangerous voltage points or other risks.

QUICK START GUIDE

This guide is designed to get you up and running in a matter of moments. To get the most out of this advanced scouting tools, please read the manual thoroughly before operating the camera. If you would like to modify any of the factory Default Settings, except for the Time & Date, please see manual for instructions.

FACTORY DEFAULT SETTINGS:

Time Out: 30 Sec **Burst Mode:** 1 Still Image (1.3Mp Resolution)
Operation Mode: PIR **Video Mode:** 10 Seconds (VGA Resolution)
Time lapse setting: 18:00-8:00 (Next day)

Initial Camera Set-up:

1. Install 8 "AA" cell batteries in correct polarity (+/-) as indicated in battery compartment.
2. Insert SD card into the camera.
3. Turn Power/Preset switch to **Preset A** to adjust the Time and Date.
4. The internal LCD screen displays **TIME** blinking.
5. Press the **[OK]** button to start the Time settings.
6. Press the **[UP]** or **[DN]** button to adjust the Minute setting and press **[OK]** to confirm and move to the Hour setting.
7. Repeat to set the Hour and then press **[OK]** to confirm and move to Date.
8. Adjust the Month, Day, and Year by using **[UP]** or **[DN]** button. Each time you finish an adjustment you MUST press the **[OK]** button to confirm and move to the next field for adjustment.
9. Once done, the word - **dEL** - will be blinking, this stands for Delete menu and will allow you to format your SD Card. (This will delete ALL images).
10. Press the **[OK]** button, press the **[UP]** or **[DN]** button till you see the blinking **Ft**, then press **[OK]**. This will return you to the PIR screen.
11. Press the **[MENU]** button to exit and to start using the **Preset A** settings.

BATTERY AND MEMORY INSTALLATION

WARNING: Do not use different Voltage lead acid battery other than the one specified in this section. Doing so will damage the camera and will void the warranty.

WARNING: ALWAYS have the camera in the *OFF* position when installing or removing batteries and memory card. Removing batteries or memory card while the camera is *ON* may damage the camera.

Your Stealth Cam Advanced Digital Scouting Camera is designed to operate using two different types of battery power options.

Batteries “AA” cell

The internal battery compartment accepts 8 “AA” cell batteries. Be sure to use high quality brand name alkaline batteries. Install batteries with correct polarity (+/-) as noted inside the battery compartment.

12V Lead Acid external battery

The camera is equipped with an external power jack designed to accept a barrel plug cable attached to a sealed lead acid battery. (Sold separately). Battery cable and complete 12V Lead Acid battery kits are available wherever Stealth Cam scouting cameras are sold or call toll free 877-269-8490. Only Stealth Cam external battery accessories are recommended.

- Make sure camera is in the *OFF* position.
- Insert the external battery barrel plug into the DC 12V jack on the bottom of camera housing.
- Turn the camera to a **Preset** or **Manual** switch setting.

NOTE: Please make sure the voltage and polarity (+/-) are correct before connection. Incorrect voltage or polarity (+/-) will damage the camera. When both internal and external batteries are connected, the camera will draw power from the higher voltage source first.

Memory Options

The camera is also equipped with an expandable media card slot capable of accepting up to 16GB SD card with Class 6 or below speed rating (sold separately). The front counter display will show the number of images stored on the SD card. If no SD card is inserted the front counter display will show "NOSd".

WARNING: The above camera will not accept Class 10 or above speed rating SD memory cards.

Inserting SD memory card

NOTE: Make sure camera is in the OFF position whenever adding or removing memory.

- Insert SD memory card in to the SD card slot completely and in the correct direction as shown by the sticker located at the side of the housing.
- To remove the SD memory card, depress the SD card and pull out the card gently.
- SD cards must be clean (no images from other sources). If you are using the SD card from other cameras, please make sure to format the SD card in your computer prior to use in your camera. New cards are good to use straight from the package.

FORMAT – Definition: When you format a SD memory card, the operating system erases all information and files on the card. Then it creates an internal address tables that it later uses to locate information and files. Formatting also removes all Hidden System files as well. Basically it cleans your SD memory card just like if it was brand new. Please make sure to follow the guidelines listed below:

SD Card size: 2Gb or below, format using File System type “FAT”.

SD Card size: 4GB or above, format using File System type “FAT32”.

DO NOT USE File System type: “NTFS” or “exFAT”, these formats are not supported.

SETUP AND PROGRAMMING

When the camera is first turned in the **Manual** setting, the internal LCD screen displays the camera status. The following information is present on this screen.

(*Passive Infrared Mode*)



(*Time-Lapse Mode*)



If no buttons are pressed after 30 seconds the LCD screen will power down to conserve battery life and enter 1-minute count down to enter PIR detection mode. To re-power the display screen, press and hold the UP or DOWN button until you see the status screen.

Definitions

- **Day and Time:** Displays the date and time that you have set.
- **Operation mode:**
 - **PIR (Passive Infrared):** Camera takes Image/Video per PIR trigger.
 - **Time Lapse (tLS):** Camera takes the still image per preset time.
- **Capturing Sequence mode / Burst mode:**
 - **1P - 9P:** 1 to 9 burst mode image capturing per PIR trigger.
 - **Video:** 10 to 180 seconds' adjustable video per PIR trigger.
- **Resolution for Images:** Color Daytime / Black & White Nighttime
 - **3 Stars (8Mp):** Select this option to capture an 8.0M pixels image. (High image quality interpolated from 5M sensor)
 - **2 Stars (3Mp):** Select this option to capture a 3.0M pixels image. (Low image quality)



- **1 Star (1.3Mp):** Select this option to capture a 1.3M pixels image. (Base image quality) (Default) 
- **Resolution for Video:** Color Daytime / Black & White Nighttime
 - **VGA:** 640 x 480
- **Time out:** Sets the amount of time in Seconds / Minutes the camera will sleep between PIR triggering or Time Lapse.
- **Temp stamp:** Temperature stamp will display on all still images and first frame “only” on video files.
- **Moon phase:** Displays the moon phases.
- **Zoom:** Adjusts the digital zoom enhancement level.
 - 1X: Normal – the word “ZOOM” will not display.
 - 2X: Two times zoom – the word “ZOOM” will display.
 - 4X: Four times zoom – The word “ZOOM” will blink.
- **Battery Status:** Shows the battery life status. Icon is always present.
 - FULL: The battery is full; the battery icon shows full.
 - HALF: The battery is half; the battery icon shows full and blinking.
 - LOW: The battery is low, the battery icon is on, empty and blinking.



Icon on



Icon in blinking



Icon off

NOTE: When the camera detects low batteries, the camera unit will power off within 30 seconds automatically. Please replace with new batteries; otherwise the camera may not work properly.

Setting the Preset Program Selection Mode:

This camera is equipped with 4 Program selection toggle switch settings. Make sure camera is in the OFF position **BEFORE** changing any toggle switches.

NOTE: If you choose one of the Preset settings, your camera will only function in PIR mode not Time Lapse mode.

- **PRESET A** - This bypasses all user defined settings and uses the following settings: (PIR mode / Resolution: 1.3MP / Burst: 3P / Time out: 30 seconds).



- **PRESET B** - This bypasses all user-defined settings and uses the following settings: (PIR mode / Resolution: 1.3MP / Burst: 6P / Time out: 30 seconds).



- **PRESET C** - This bypasses all user-defined settings and uses the following settings: (PIR mode / Video: VGA / Video clip: 10s / Time out: 30 seconds).



- **MANUAL** - This allows the user to define what setting the camera will use.

Programming the Stealth Cam using *MANUAL* mode

Setting the Camera's Operation Mode:

Your Stealth Cam can be programmed to operation either in PIR Detection mode or Time Lapse / PIR mode.

- Switch the camera to the *Manual* position.
 - LCD screen will display the camera status screen.
- Press the [MENU] button once within 30 seconds to enter the programming mode, the word **PIR** or **tLS** will be blinking.



- Press the [UP] or [DN] button to select **PIR** mode.
- Press [OK] to save your selection.
- Press [MENU] button to exit.

Setting the Resolution in PIR mode:

Your Stealth Cam can be programmed to 3 different resolutions: High (3 Stars-8Mp), Low (2 Stars-3Mp), Base (1 Star-1.3Mp).

- Switch the camera to the *Manual* position.
 - LCD screen will display the camera status screen.
- Press the [MENU] button once within 30 seconds to enter the programming mode.

- The word **PIR** will be blinking, press **[OK]** to confirm the camera's operation is PIR detection.
- The word **CAMERA** and the **STARS** will be blinking.
- Press the **[OK]** button ONCE to choose the selection.
- Press the **[UP]** or **[DN]** button to select the desired resolution.
- Press **[OK]** to save your selection.
- Press **[MENU]** button to exit.

Setting the Capturing Sequence in PIR mode:

Your Stealth Cam can be programmed to shoot 1-9 pictures per triggering.

- Switch the camera to the *Manual* position.
 - LCD screen will display the camera status screen.
- Press the **[MENU]** button once within 30 seconds to enter the programming mode.
- The word **PIR** will be blinking, press **[OK]** to confirm the camera's operation is PIR detection.
- Press the **[UP]** button ONE time to enter the Capturing Sequence setting mode.
- The word **CAMERA** will be blinking.
- Press **[OK]** button and the current number of burst mode images will blink.
- Press the **[UP]** or **[DN]** button to select the desired burst mode setting or number of pictures per triggering.
- Press **[OK]** to save your selection.
- Press **[MENU]** button to exit.

Setting the Video in PIR mode:

Your Stealth Cam can be programmed to record 10-180 seconds of video per triggering. The Video mode is only workable under PIR mode.

- Switch the camera to the **Manual** position.
 - LCD screen will display the camera status screen.
- Press the **[MENU]** button once within 30 seconds to enter the programming mode.
- The word **PIR** will be blinking, press OK to confirm the camera operation by PIR detection.
- Press **[UP]** button TWO times to enter Video setting mode.
- The word **VIDEO** will be blinking.
- Press **[OK]** button and the video length in seconds will be blinking.
- Press **[UP]** or **[DN]** button to select the desired video length from 10 to 180 seconds in 5-second increments.
- Press **[OK]** to save your selection.
- Press **[MENU]** button to exit.

Set the Digital Zoom in PIR mode:

Your Stealth Cam can be programmed to have 3 different zoom levels.

- Switch the camera to the **Manual** position.
 - LCD screen will display the camera status screen.
- Press the **[MENU]** button once within 30 seconds to enter the programming mode.
- The word **PIR** will be blinking, press OK to confirm the camera operation by PIR detection.

- Press **[UP]** button THREE times to enter Zoom setting mode.
- The word **ZOOM** will be blinking.
- Press **[OK]** button and the zoom level number will now blink.
- Press the **[UP]** or **[DN]** button to select the desired zoom level setting 1 (1X Normal) / 2 (2X Zoom) / 4 (4X Zoom).
- Press **[OK]** to confirm your selection
- Press **[MENU]** button to exit.

NOTE: *The use of the digital zoom feature may degrade image & video quality, as this tells the camera to focus on a specific are of the image and increase its size. This will cause dithering of the image.*

Setting the Time Out in PIR mode:

Your Stealth Cam can be programmed to set the amount of time in seconds or minutes the camera will sleep between PIR triggers.

- Switch the camera to the **Manual** position.
 - LCD screen will display the camera status screen.
- Press the **[MENU]** button once within 30 seconds to enter the programming mode.
- The word **PIR** will be blinking, press **[OK]** to confirm the camera operation by PIR detection.
- Press **[UP]** button FOUR times to enter Time Out setting mode.
- The word **TIME OUT** will be blinking.
- Press **[OK]** button and the MINUTES digits will be blinking.
- Press **[UP]** or **[DN]** button to increase or decrease the time value in minutes from 00 to 59 seconds in 1-minute increments.

- Press **[OK]** to save the seconds setting and the SECONDS digits will be blinking.
- Press **[UP]** or **[DN]** button to increase or decrease the time value in seconds from 05 to 59 minutes in 1-second increments.
- Press **[OK]** to save the minutes setting.
- You'll then see the word **TIME** blinking.
- Press **[MENU]** button to exit.

Setting the Time and Date in PIR operation mode:

Your Stealth Cam uses the 24hr military time format.

- Switch the camera to the **Manual** position.
 - LCD screen will display the camera status screen.
- Press the **[MENU]** button within 30 seconds to enter the programming mode.
- The word **PIR** will be blinking, press OK to confirm the camera operation by PIR detection.
- Press **[DOWN]** button TWO times to enter Time and Date mode.
- The word **TIME** will be blinking.
- Press **[OK]** to enter Minute setting first.
- The **MINUTE** digits will be blinking.
- Press **[UP]** or **[DN]** to increase or decrease the minute value (00 – 59).
- Press **[OK]** to save your selection and enter Hour setting.
- The **HOUR** digits will be blinking.
- Press **[UP]** or **[DN]** to increase or decrease the hour value (00 – 23).
- Press **[OK]** to save your selection and enter Month setting.

- The **Month** digits will be blinking.
- Press [**UP**] or [**DN**] to increase or decrease the Month value (1 - 12).
- Press [**OK**] to save your selection and enter Day setting.
- The **Day** digits will be blinking.
- Press [**UP**] or [**DN**] to increase or decrease the Day value (01 – 31).
- Press [**OK**] to confirm the Date setting and enter Year setting.
- The **YEAR** digits will be blinking.
- Press [**UP**] or [**DN**] to increase or decrease the Year value (01 – 99).
- Once this is all done, press [**OK**].
- You'll then see the word - **dEL** - blinking.
- Press [**MENU**] button to exit the program setting and back to the status screen.

Setting the Time Lapse Mode:

The Time Lapse default setting value is from 18:00 to 08:00 the next day. When the camera is set to use the Time-Lapse mode (tLS), the program settings will follow the Time Lapse settings. Outside of the Time Lapse time frame; the camera will follow the user defined PIR settings.

The user can set the program for a pre-determined time period [such as 18:00 to 08:00]. The user then sets the frequency of still images only (video function not available in Time Lapse mode). The camera will remain in Time Lapse mode until the user has changed the program setting.

- Switch the camera to the **Manual** position.
 - LCD screen will display the camera status screen.
- Press the [**MENU**] button once within 30 seconds to enter the programming mode.

- Press **[UP]** button until you see the word tLS blinking.
- Press **[OK]** to confirm and go into TLS Mode "Start Time" setting.
- The display will show TIME + S 88:88 (S = Start, 88:88 = time in HH:MM)
- Press **[OK]** to set the "Start Time" setting. At this point you can adjust the time from 00:00 to 23:59.
- The **MINUTE** digits will be blinking.
- Press **[UP]** or **[DN]** to increase or decrease the minute value (00 – 59).
- Press **[OK]** to save your selection and enter Hour setting.
- The **HOUR** digits will be blinking.
- Press **[UP]** or **[DN]** to increase or decrease the hour value (00 – 23).
- Press **[OK]** to save the "Start Time" setting and move to the "End Time" setting.
- After completing the start time setting, camera will go into TLS Mode "End Time" setting.
- The display will show TIME + E 88:88
- (E = End, 88:88 = time in HH:MM)
- At this point you can adjust the time from 00:00 to 23:59 by pressing the **[UP/DN/OK]** buttons same as Start Time settings.
- Press **[OK]** to save the "End Time" settings and move directly to the TIME OUT setting.



- Please complete the TIME OUT, Still image resolution, Burst Mode, Zoom settings like the settings on the PIR operation mode.
- Then press **[MENU]** button to exit.

EXAMPLE:

#1: *If a user selected the Time Lapse mode, and sets the Start Time to 07:00 and End Time at 20:30, then selects the Timeout to be 3 mins with a Burst mode of 3 pictures, this means that the camera will keep taking 3 pictures for every 3 minutes within the time frame of 7:00AM to 8:30PM. When not within the Time Lapse time frame, the camera will follow the normal PIR detection settings.*

#2: *If a user selected the Time Lapse mode setting as Start Time 00:00 and End Time 00:00, then selected the Timeout to be 5 mins with a Burst mode of 3 pictures, this means the camera will keep taking 3 pictures for every 5 minutes, 24 hours a day non-stop.*

TIME LAPSE SETUP RECOMMENDATIONS:

We recommend that if your using the Time Lapse feature and what to extend your battery life and get the most pictures possible, use the following settings:

Batteries: Energizer Lithium Batteries

Resolution: Base (1 Star-1.3Mp)

Time Out: 15 seconds

Setting up the camera in the field:

Once all program settings have been setup properly, your Stealth Cam is ready for field use.

Getting started

Listed below are some helpful pointers on how to use your camera to get the best results.

- Mount the camera about 4-5 feet high with the camera pointed at a slight downward angle.
- Mount the camera facing north or south **NOT** east or west due to the rising and setting of the sun could produce false triggers and overexposed images.
- If you're covering a trail, face the camera down or up the trail. Most commercial cameras take 1-3 seconds to sense motion/heat and take a picture.
- Clear out any brush or weeds in front of camera. This will cause false pictures caused wind or high temperature days.
- Double check battery before turning on the camera for use.
- Make sure to insert the memory card after setting up the game camera.
- Make sure to turn the camera to **Preset** or **Manual** mode (or take out of Test Mode) before you leave.
- Verify time and date is correct.

(Example: Mounting)

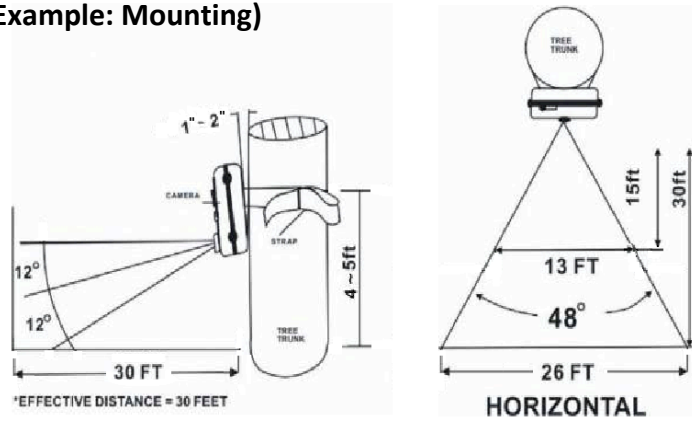

(Example: Trail Setup)

Incorrect

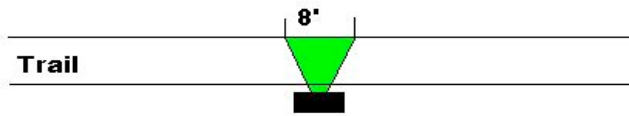

Correct

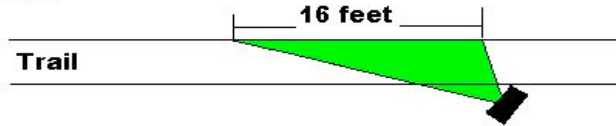

USING THE CAMERA IN PIR DETECTION MODE

- Mount the camera to the tree or other sturdy object using either a tree screw (optional accessory) or supplied mounting strap.
- Open the front housing and move the switch to either one of the **Preset** modes or **Manual** mode. At this point, you have 30 seconds to make any mode selection changes before camera is ready to use.
- If you chose **Manual** mode then make sure your camera is in the **PIR** mode and not Time Lapse (tLS). If your not sure, please follow the “**Setting the Camera’s Operation Mode**” above to set the camera into the proper mode.

To Capture Images, make sure display reads CAMERA:

- Once in Manual mode, if the display does **not** read CAMERA then,
 - Press the **[MENU]** button once.
 - Press the **[OK]** button once.
 - The word **CAMERA** will blink.
 - Press the **[UP]** button ONE time to toggle to Camera mode.
 - Press the **[OK]** button TWO times.
 - Press the **[MENU]** button once to exit.

To Capture Videos, make sure display reads VIDEO:

- Once in Manual mode, if display does **not** read VIDEO then,
 - Press the **[MENU]** button once.
 - Press the **[OK]** button once.
 - The word **CAMERA** will blink.

- Press the **[UP]** button TWO times to toggle to Video mode.
 - Press the **[OK]** button TWO times.
 - Press the **[MENU]** button once to exit.
- 30 seconds after you've made your adjustments, the camera's green LED light will begin blinking and enter count down mode. This is your indication to leave the coverage area within one minute.
 - After one minute, the camera will enter either Burst mode or Video mode based on your program setting. The camera will then time out between 05-59 seconds or 1-59 minutes, depending on your program setting.

NOTE: The time between motion detection and the camera taking the pictures may vary due to lighting conditions, program settings, and battery power level. The IR Emitter will only activate in low light conditions.

USING THE CAMERA IN TIME LAPSE MODE

- Mount the camera to the tree or other sturdy object using either a tree screw (optional accessory) or supplied mounting strap.
- Open the front housing and move the switch to the **Manual** mode.
- Make sure your camera is in Time Lapse (**tLM**) mode and not PIR mode. If your not sure, please follow the "**Setting the Camera's Operation Mode**" above to set the camera into tLM mode.
- The camera's green LED light will begin blinking and enter count down mode. This is your indication to leave the coverage area within one minute. After one minute, the camera will enter Time Lapse mode.

VIEWING AND DELETING FILES

The STC-U840IRS1 cam offers the user different options for viewing their images. You can view images or videos through either on your computer, a handheld LCD monitor or even your home TV that's equipped with an RCA Input jack. The external LCD display on the front of the housing will show the number of images stored on the SD memory card.

NOTE: The instructions below are based on starting with a camera that's power is turned off.

Viewing files by computer

Your Stealth Cam Digital Scouting Camera is a plug and play USB storage device for users of Windows 2000 / ME / XP / Vista / Windows 7 operating systems. This camera is not MAC compatible.

Viewing files on your computer via USB connection.

- Make sure the camera's power switch is in the *OFF* position.

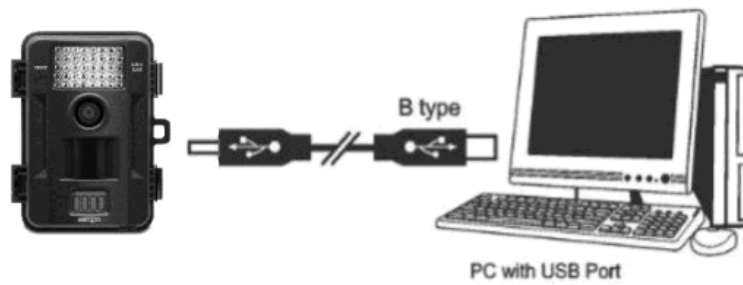

- Plug the larger end of the USB cable into an available USB port on your computer.
- Plug the smaller end of USB cable into the camera's side panel.
- The camera will *automatically* power *ON* and display the word **USB** on the display screen.



- At the same time, your computer will recognize the camera as a Removable Storage device. You will find it under MY COMPUTER.
- At this point you have several options:
 - **To view your images or play your videos:** Click on the Removable Storage device and then drill down to the file you want to see and double click on the file name.
 - **To save your images and videos:** Highlight the file or files you want to save and drag them to your hard drive.
 - **To delete your images and videos:** Highlight the files or files you want to delete and press the **[DELETE]** button.
 - **To erase all files and reformat you SD memory card:** Right click on the Removable Storage device under My Computer and select **FORMAT** then click **START**. You will receive a Warning message press **[OK]**. Then **CLOSE** to exit.

NOTE: Make sure before you FORMAT you are certain it is the Removable Storage device for the camera.

- Once you're done, simply unplug the cable from both your computer and the camera. The camera will turn OFF automatically.

For viewing on handheld LCD monitor:

- Attach the appropriate cable to the TV port on the side of the camera.
- Insert the other end into the VIDEO IN jack on the handheld LCD video monitor.
- Turn on both the camera and the monitor.
- You will see a series of thumbnail images on your monitor.
- Press the **[UP]** or **[DN]** button to navigate through your thumbnail images.
- On the upper left hand corner of your TV monitor, it will either display the image OR the image with a video icon which indicates it's a video clip.
- To view in full screen, press the **[OK]** button.
- Press the **[OK]** button again, it will return to the thumbnail view from the full screen image.



For viewing on your home TV monitor:

- Attach the appropriate cable to the TV port on the side of the camera.
- Insert the other end into the RCA VIDEO IN jacks on the TV.
- Turn on both the camera and the TV monitor.
- Make sure to switch to AUX / VIDEO IN mode on your TV.
 - (See your TV owner's manual for directions).
- The camera's TV OUT is set to NTSC by default. (NTSC – Standard North American TV format)
 - If the TV monitor doesn't flicker, then you do not need to change your camera's TV OUT setting. Proceed to the next section called **Thumbnail Images**.

➤ If the TV monitor does flicker, then you will need to proceed to the next step to change your camera's TV OUT from NTSC to PAL (Standard European TV format).

- Press the **[MENU]** button once.
- The word “**tu**” on the camera's internal screen will be blinking.
- Press the **[OK]** once and now you'll see “**tu - n**” blinking.
- Press the **[DN]** button to set the camera's TV OUT to PAL.
- The word “**tu - P**” will now be blinking.
- Press the **[OK]** to confirm this setting.
- The word “**tu - P**” will be blinking and then stops.
- Once the blinking stops, power off the camera. Wait for 5 seconds and then power up your camera again.



Viewing Video Clips on handheld LCD monitor or home TV monitor

- Follow the cable attaching instruction listed in previous section.
- You will see a series of thumbnail images on your monitor.
- Press the **[UP]** or **[DN]** button to choose the video clip you want to watch.
- Press the **[OK]** button to play the video clip.
- You may pause the video clip by pressing the **[OK]** button during the playback. Press **[OK]** button to resume playing.

- At the end of the video clip, press the **[UP]** or **[DN]** button to proceed to the next video or image. If it is a video clip file, then it will automatically start to play. If it is still image file then it will show the image in full screen.
- When you view still images in full screen, you can return to thumbnail image selection view by pressing the **[OK]** button.

NOTE: All videos are recorded with audio but only have sound when viewing playback on a PC.

Deleting files in the field

- Switch the camera to the *ON* position.
 - LCD screen will display the camera status screen.
- Press the **[MENU]** button within 30 seconds to enter the programming mode.
- Press the **[DN]** button ONCE to enter the delete mode.
- You'll see the word - **dEL** - blinking.
- Press **[OK]** button to enter the DELETE & FORMAT menu.
- Press **[UP]** or **[DN]** button to select the desired function.
 - NO-dL (No Delete) - No images get deleted.
 - d-ONE (Delete One) - Only the last file will get deleted.
 - d-ALL (Delete ALL) - Deletes ALL images on the SD card.
 - Ft (Format) - Deletes all files and reformats the SD card.

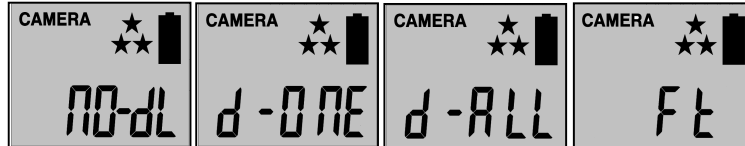

- Press **[OK]** to confirm your selection.
- Press **[MENU]** button to exit the program setting and back to the status screen.

MEMORY COMPATIBILITY CHART

The following cards have been tested and approved for use with the STC-U840IRS1 model.

Kingmax	2G
Sandisk	2G, 4G, 8G, 16G
Toshiba	2G
PNY	2G, 4G, 8G, 16G
Kingston	2G, 4G, 8G, 16G
First Champion	1G, 2G, 4G, 8G, 16G
Digilux	1G, 2G
Lexar	4G, 8G, 16G
DANE-ELEC	4G, 8G, 16G
Kodak	16G

NOTE: Proper camera operation cannot be guaranteed when using memory cards NOT listed above.

TECHNICAL SPECIFICATIONS

System Requirements and Compatibility

- Windows Me/2000/XP/Vista/Windows 7
- Pentium 4, 2GHz or above
- 1GB RAM (2GB recommended)
- 32 bits color, Resolution 800x600 or above w/ 256MB
- 2GB free hard disc space
- An available USB 1.1 port (USB 2.0 recommended)
- Direct X 9.0 or above – Should come with your operating system already.
- Optional: Windows compatible sound card and speaker.

NOTE: If you have any questions regarding your PC specifications please contact your PC manufacturer.

Camera Features and Specification

- High precision multi-layer glass lens with coating.
- Built in 1.85" B&W LCD display.
- External memory support: SD memory card up to 16GB.
- Resolution Options: 8.0M, 3.0M, 1.3M.
- Image interpolated from 5M Sensor
- Capturing Options: 1 - 9 image burst mode or video recording with audio.
- Time Lapse Mode: Sets the frequency of pictures during a time period.
- Hybrid mode: PIR capture and Time Lapse mode auto changing.
- Time Out Feature: 5 secs – 59:59 mins
- Image format: Standard JPEG
- Auto white balance and auto expose.
- Auto IR emitter light control.
 - Effective Range for Still picture (up to 50 ft).
 - Effective Range for Video clip (up to 50 ft).
- Real time clock for date and time stamping.
- 4 digits LCD Image counter.
- Low Battery LED indicator.
- Green TEST LED indicator.
- Focusing: 5 ft to infinity.
- Effective viewing angle: 50 degrees
- PIR detection angle: 48 degrees
- Interface type: USB 1.1
- Power: AA size alkaline or lithium Batteries x 8
- External power: 12 volts battery pack

IMAGE CAPACITY CHART

SD card	High Color	High B&W	Low Color	Low B&W	Base Color	Base B&W	AVI Color	AVI B&W
Based on File size of	5MB	3MB	2.0MB	1MB	1MB	0.5MB	70MB (30sec.)	30MB (30sec.)
1GB	204	340	512	1024	1024	2048	14	34
2GB	408	680	1024	2048	2048	4096	28	68
4GB	816	1360	2048	4096	4096	8192	56	136
8GB	1632	2720	4096	8192	8192	16384	112	272
16GB	3264	5440	8192	16384	16384	32768	224	544

**Subject to card compatibility under different brands.





































NOTE: Image Capacity Chart provides approximate number of images or AVI movies based on resolution settings and the size of the memory card. These figures may vary depending on the amount of detail in the image.

When the SD card is **NOT FULL**, but camera's front counter already reaches 9999, the camera will create a new folder to save the next data. Camera's front counter will reset to 0000. On the other hand, when SD card is full, camera's counter will then change the display to read "**FULL**". Images and Videos under each folder will be named from 00001 up to 99999.

SD Card Capacity and Compatibility

Due to the rapidly changing memory card market please consult www.stealthcam.com for the most up to date information regarding memory cards.

MOON PHASE SYMBOL CHART

Symbol	Lunation from to		Actual phase				
	1	5					
	6	10					
	11	14					
	15	16					
	17	20					
	21	25					
	26	29 or 30					

FREQUENTLY ASKED QUESTIONS

Q: *What does it mean when I have all 8's on my LCD screen?*

A: *This usually refers to an incompatible memory card or memory card damaged. Make sure your card has been properly formatted.*

Q: *Is the infrared flash invisible?*

A: *The infrared flash will give off a low glow red light it is not invisible.*

Q: *Is my game camera Mac compatible?*

A: *Yes, This camera model works with 10.6 and above.*

Q: *Can I use rechargeable batteries in the camera?*

A: *Rechargeable batteries are fine for the unit, regular alkaline batteries designed for digital electronics are recommended for best performance.*

Q: *When I use a memory card can I view the pictures on my personal digital camera?*

A: *We do not recommend viewing SD memory card images taken in your game camera on any other digital camera, you may experience compatibility issues.*

Q: *Will I lose my images and setting when the batteries die?*

A: *The images are stored on your external SD memory card so your images will be intact only on your card. However you will need to reset your settings.*

Q: *What are my options if my camera is past it warranty?*

A: *We have an out of warranty program in which you may purchase a refurbished/reconditioned replacement unit for 50% or more off (based on retail price of unit) discount exchange of your old unit.*

Q: *Can I use my game camera through a window or glass door?*

A: *Glass may disrupt your sensor beam we don't advise using the camera in this fashion.*

Q: *Do I need to recharge my 12V Battery Kit during the seasons it's not in use?*

A: *The 12V Battery Kit should be recharge at least every 3 months, regardless if it is being used or not, in order to preserve the working condition of the battery inside the unit.*

NOTE: *For the latest updates and information please check our website regularly.*

WARNING: *Modification not approved by the party responsible for compliance could void user's authority to operate.*

FCC Compliance

This equipment has been tested and found to comply with the limits for Class B digital device, pursuant to part 15 of the FCC Rules. These limits are designed to provide reasonable protection against harmful interference in a residential installation. This equipment generates uses and can radiate radio frequency energy and, if not installed and used in accordance with the instructions, may cause harmful interference to radio or television receptions, which can be determined by turning the equipment off and on, the user is encouraged to try to correct the interference by one or more of the following measure:

- Reorient or relocate the receiving antenna.
- Increase the separation between the equipment and the receiver.
- Connect the equipment into an outlet on a circuit different from that to which the receiver is connected.
- Consult the dealer or an experienced radio/TV technician for help.
- Shield USB cable with ferrite must be used with this unit to ensure compliance with the Class B FCC limits.

This device complies with part 15 of the FCC Rules. Operation is subject to the following two conditions: (1) This device may not cause harmful interference, and (2) this device must accept any interference received, including interference that may cause undesired operation.

Product specifications are subject to change. Stealth Cam is not responsible for any photographic or typographical errors.

May be protected by one or more U.S. Patent numbers: 6,735,387 / 6,768,868 / 6,834,162 / 7,149,422 / 7,308,196 / 7,593,632 / 7,710,457 / 7,873,266

WWW.STEALTHCAM.COM
Toll Free 877-269-8490