



92

PISTOL  
USER MANUAL



BERETTA



# TABLE OF CONTENTS

BASIC SAFETY RULES .....	4
DESCRIPTION .....	10
MAIN CHARACTERISTICS .....	10
GENERAL OPERATION .....	13
TECHNICAL FEATURES AND DATA .....	14
LOADING AND FIRING .....	16
MAINTENANCE .....	21
HOW TO ASSEMBLE THE ADJUSTABLE REAR SIGHT .....	24
ADJUSTING THE REAR SIGHT .....	25
HOW TO REVERSE THE MAGAZINE RELEASE BUTTON .....	25
TROUBLESHOOTING .....	26
AMMUNITION .....	27

WARNING, CAUTION and Notice headings are defined as follows:

 **WARNING:**

The purpose of a **WARNING** is to draw attention to a potential dangerous situation that could result in personal injury.

 **CAUTION:**

A **CAUTION** concerns potential damage to firearm.

 **Notice:**

A **NOTICE** highlights important procedures and statements that require more emphasis than general text.

Illustrations in the manual refer to CX4 Storm.

The references “left” or “right” always refer to the firearm as hold by the user.

**The contents of this manual are subject to change without notice.**

**⚠ Notice:** always keep this manual with your firearm. Include it with the pistol when it changes ownership or when it is loaned or presented to another person.

**⚠ Notice:** The Manufacturer and/or its Local Official Distributors assume no responsibility for product malfunction or for physical injury or property damage resulting in whole or in part from criminal or negligent use of the product, improper or careless handling, unauthorized modifications, use of defective, improper, hand-loaded, reloaded or remanufactured ammunition\*, customer abuse or neglect of the product, or other influences beyond manufacturer's direct and immediate control.

\* See paragraph "Ammunition".

**⚠ WARNING:** always ensure safety is engaged – if present until ready to fire. A safety, which is not fully engaged, will not prevent firearm discharge.

**⚠ WARNING:** ALL FIREARMS HAVE LETHAL POTENTIAL. READ THE BASIC SAFETY RULES CAREFULLY AND UNDERSTAND THEM FULLY BEFORE ATTEMPTING TO USE THIS FIREARM.

**⚠ Notice:** In addition to the Basic Safety Rules, there are other Safety Rules pertaining to the loading, unloading, disassembly, assembly and use of this firearm, located throughout this manual.

**⚠ WARNING:** READ THE ENTIRE MANUAL CAREFULLY BEFORE USING THIS FIREARM. MAKE SURE THAT ANY PERSON USING OR HAVING ACCESS TO THIS FIREARM READS AND UNDERSTANDS ALL OF THIS MANUAL PRIOR TO USE OR ACCESS.

**⚠ Notice:** we recommend the use of original Beretta spare parts and accessories. The use of other manufacturer's spare parts and accessories could cause malfunctions and/or breakages that will not be covered by the Beretta warranty.

# BASIC SAFETY RULES

**⚠ WARNING: PLEASE READ THIS MANUAL BEFORE HANDLING YOUR FIREARM.**

**⚠ WARNING: FIREARMS CAN BE DANGEROUS AND CAN POTENTIALLY CAUSE SERIOUS INJURY, DAMAGE TO PROPERTY OR DEATH, IF HANDLED IMPROPERLY. THE FOLLOWING SAFETY RULES ARE AN IMPORTANT REMINDER THAT FIREARM SAFETY IS YOUR RESPONSIBILITY.**

## 1. NEVER POINT A FIREARM AT SOMETHING THAT IS NOT SAFE TO SHOOT.

Never let the muzzle of a firearm point at any part of your body or at another person. This is especially important when loading or unloading the firearm. When you are shooting at a target, know what is behind it. Some bullets can travel over a mile. If you miss your target or if the bullet penetrates the target, it is your responsibility to ensure that the shot does not cause unintended injury or damage.



## 2. ALWAYS TREAT A FIREARM AS IF IT WERE LOADED.

Never assume that a firearm is unloaded. The only certain way to ensure that a firearm has the chamber(s) empty is to open the chamber and visually and physically examine the inside to see if a round is present. Removing or unloading the magazine will not guarantee that a firearm is unloaded or cannot fire. Firearms can be checked by

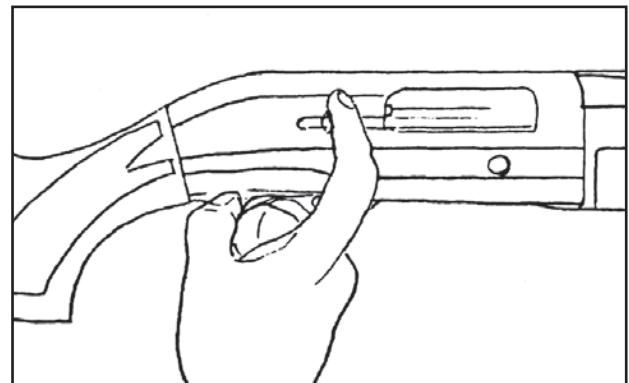
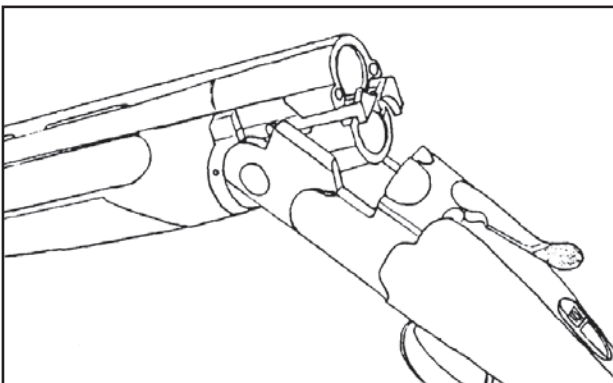
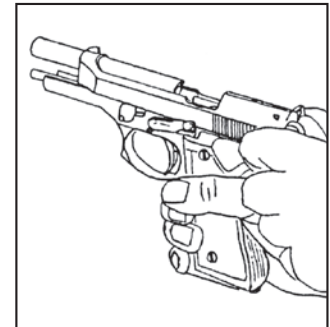

cycling or removing all rounds and by then opening and inspecting the chamber so that a visual inspection of the chamber for any remaining rounds can be made.

### **3. STORE YOUR FIREARM SO THAT CHILDREN CANNOT GAIN ACCESS TO IT.**

It is your responsibility to ensure that children under the age of 18 or other unauthorized persons do not gain access to your firearm. To reduce the risk of accidents involving children, unload your firearm, lock it and store the ammunition in a separate locked location. Please note that devices intended to prevent accidents - for example, cable locks, chamber plugs, etc. - may not prevent use or misuse of your firearm by a determined person. Firearm storage in a steel gun safe may be more appropriate to reduce the likelihood of intentional misuse of a firearm by an unauthorized child or person.

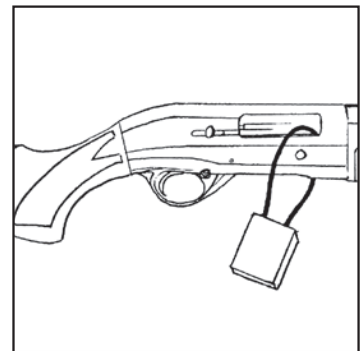
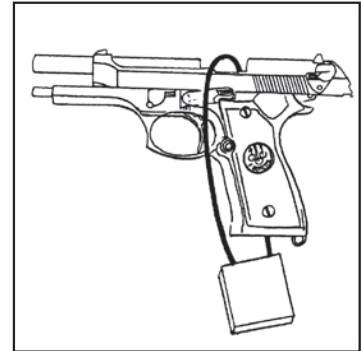

### **4. NEVER SHOOT AT WATER OR AT A HARD SURFACE.**

Shooting at the surface of water or at a rock or other hard surface increases the chance of ricochets or fragmentation of the bullet or shot, which can result in the projectile striking an unintended or peripheral target.

### **5. KNOW THE SAFETY FEATURES OF THE FIREARM YOU ARE USING, BUT REMEMBER: SAFETY DEVICES ARE NOT A SUBSTITUTE FOR SAFE HANDLING PROCEDURES.**

Never rely solely on a safety device to prevent an accident. It is imperative that you know and use the safety features of the particular firearm you are handling, but accidents can best be prevented by following the safe handling procedures described in these safety rules and elsewhere in the product manual. To further familiarize yourself with the proper use of this or other firearms, take a Firearms Safety Course taught by an expert in firearms use and safety procedures.

### **6. PROPERLY MAINTAIN YOUR FIREARM.**

Store and carry your firearm so that dirt or lint does not accumulate in

the working parts. Clean and oil your firearm, following the instructions provided in this manual, after each use to prevent corrosion, damage to the barrel or accumulation of impurities which can prevent use of the gun in an emergency. Always check the bore and chamber(s) prior to loading to ensure that they are clean and free from obstructions. Firing with an obstruction in the barrel or chamber can rupture the barrel and injure you or others nearby. In the event you hear an unusual noise when shooting, stop firing immediately, engage the manual safety and unload the firearm. Make sure the chamber and barrel are free from any obstruction, like a bullet blocked inside the barrel due to defective or improper ammunition.



## **7. USE PROPER AMMUNITION.**

Only use factory-loaded, new ammunition manufactured to industry specifications: CIP (Europe and elsewhere), SAAMI® (U.S.A.). Be certain that each round you use is in the proper caliber or gauge and type for the particular firearm. The caliber or gauge of the firearm is clearly marked on the barrels of shotguns and on the slide or barrel of pistols. The use of reloaded or remanufactured ammunition can increase the likelihood of excessive cartridge pressures, case-head ruptures or other defects in the ammunition that can cause damage to your firearm and injury to yourself or others nearby.

## **8. ALWAYS WEAR PROTECTIVE GLASSES AND EARPLUGS WHEN SHOOTING.**

The chance that gas, gunpowder or metal fragments will blow back and injure a shooter who is firing a gun is rare, but the injury that can be sustained in such circumstances can be severe, including the possible loss of eyesight. A shooter must always wear impact resistant shooting glasses when firing any firearm. Earplugs or other high-quality hearing protectors help reduce the chance of hearing damage from shooting.



## **9. NEVER CLIMB A TREE, FENCE OR OBSTRUCTION WITH A LOADED FIREARM.**

Open and empty the chamber(s) of your firearm and engage the manual safety before climbing or descending a tree or before climbing a fence or jump-





ing over a ditch or other obstruction. Never pull or push a loaded firearm toward yourself or another person. Always unload a firearm, visually and physically check to see that the magazine, loading mechanism and chamber are unloaded, and action is open before handing it to another person. Never take a firearm from another person unless it is unloaded, visually and physically checked to confirm it is unloaded, and the action is open.

### 10. AVOID ALCOHOLIC BEVERAGES OR JUDGMENT/REFLEX IMPAIRING MEDICATION WHEN SHOOTING.

Do not drink and shoot. If you take medication that can impair motor reactions or judgment, do not handle a firearm while you are under the influence of the medication.



### 11. NEVER TRANSPORT A LOADED FIREARM.

Unload a firearm before putting it in a vehicle (chamber empty, magazine empty). Hunters and target shooters should load their firearm only at their destination, and only when they are ready to shoot. If you carry a firearm for self-protection, leaving the chamber unloaded can reduce the chance of an unintentional discharge.



### 12. LEAD WARNING.

Discharging firearms in poorly ventilated areas, cleaning firearms, or handling ammunition may result in exposure to lead and other substances known to cause birth defects, reproductive harm, and other serious physical injury. Have adequate ventilation at all times. Wash hands thoroughly after exposure.

**⚠️ WARNING:** It is **YOUR** responsibility to know and abide by Federal, State and Local laws governing the sale, transportation and use of firearms in your area.

**⚠️ WARNING:** This firearm has the capability of taking your life or the life of someone else! Always be extremely careful with your firearm. An accident is almost always the result of not following basic firearm safety rules.

### ESPECIALLY FOR U.S. CONSUMERS:

For information about Firearm Safety Courses in your area, please visit the National Rifle Association's web site at [www.nra.org](http://www.nra.org).

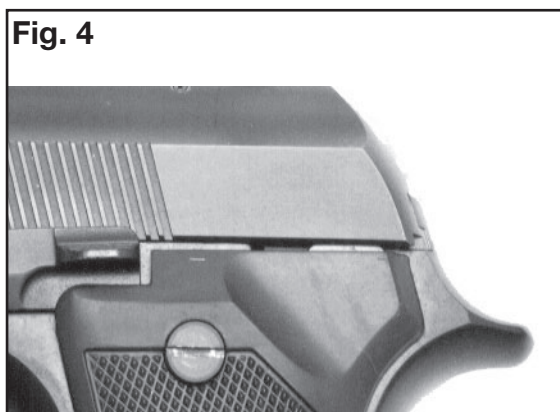
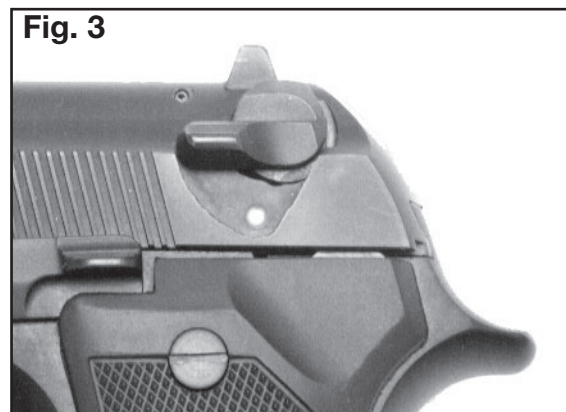
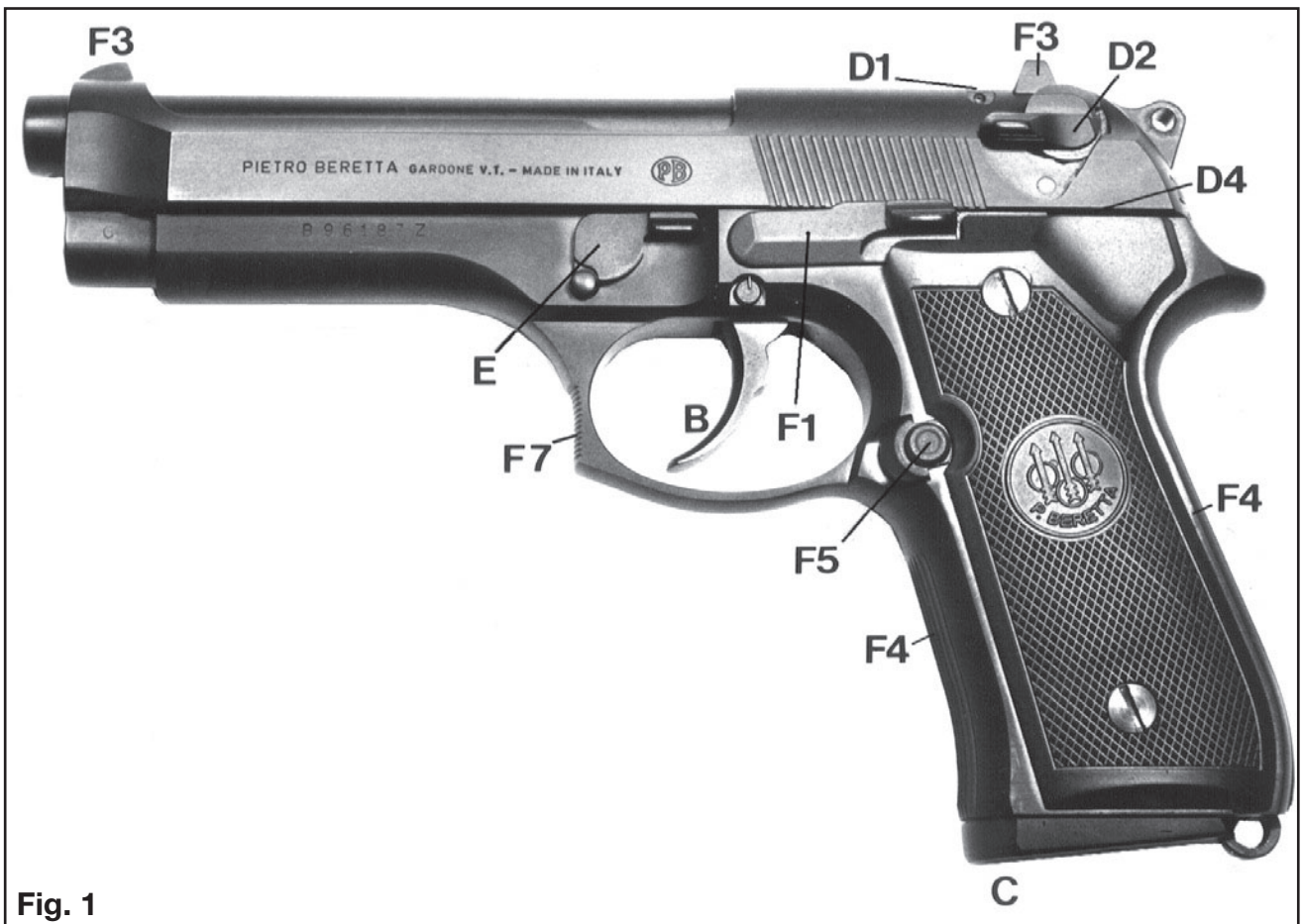

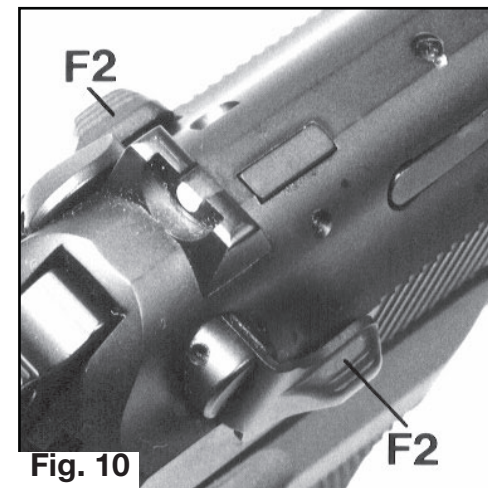
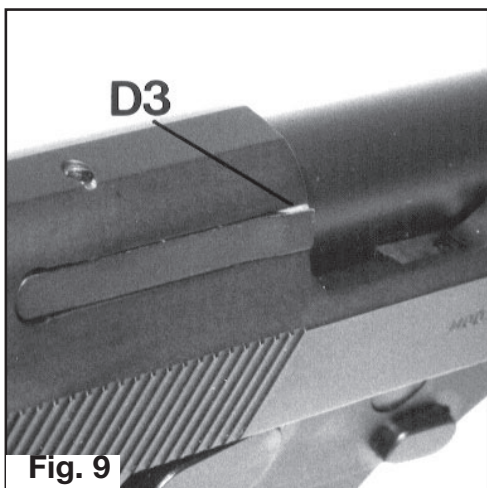
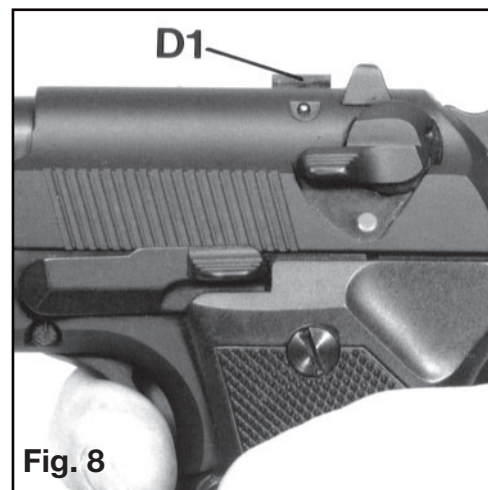

## DESCRIPTION

The Beretta 92 Series semi-automatic pistols are primarily designed for military and police use. Due to excellent performance in competitive testing 92 Series pistols are the choice of Military and Police Forces.

The characteristics of flawless reliability, complete handling safety, great fire capacity and high accuracy, proper of the basic model, have been maintained on the 98 FS versions (cal.9 mm x 21 IMI) and on the models 96 cal. .40 S & W.

Other recent additions to the 92 series are the special versions developed with the needs of some U.S. Police Forces in mind.

## MAIN CHARACTERISTICS

**A. THE LOCKING SYSTEM** with falling locking block and the barrel short recoil operation are a warranty of long-life and shooting accuracy

**B. THE DOUBLE ACTION** offers the advantages of the revolver. In the rare instance of misfire due to a faulty primer, it is sufficient to pull the trigger again to repeat the percussion on the cartridge and fire the round.

**C. THE GREAT FIRE CAPACITY**  
**Models 92 and 98** = 15 round, staggered magazine

**Model 92 FS Compact** = 13 round, staggered magazine

**Model 92 FS Compact "Type M"** = 8 round, single line magazine

**Models 96** = 11 round, staggered magazine

**Model 96 Compact** = 9 round, staggered magazine

The staggered magazine, of the same length as a traditional single line magazine, allows greater fire capacity. (**Fig. 7**)

**D. THE COMPLETE SAFETY SYSTEM**

**D1. Automatic firing pin safety:**  
when the trigger is not pulled

completely back, a blocking device secures the firing pin and prevents it from moving forward, even if the weapon should fall from a height and strike the ground muzzle-down.

**D2. Manual safety-decocking lever:** allows safe hammer lowering over a chambered round. The safety rotation interrupts and shields the firing pin unit from hammer strike. With the safety ON, the linkage between trigger and sear is disconnected.

**D3. Chamber-loaded indicator:** when a cartridge is chambered, the extractor head protrudes outside the slide breech, exposing a red warning signal. In the dark, the protrusion can be felt by touch. This makes it unnecessary to pull back the slide to verify if the chamber is loaded. (**Fig. 9**)

**D4. Slide overtravel stop:** on the FS models, the hammer pin head has been enlarged to enter a matching groove cut into the slide rail to stop slide breech recoil overtravel.

## **E. THE GREAT SIMPLICITY OF FIELD STRIPPING.**

The disassembly device is designed to allow an extremely

quick and simple field stripping of the pistol and also to avoid casual or involuntary disassembly.

## **F. THE FUNCTIONAL AND ANATOMICAL FEATURES**

**F1. Slide catch:** when the last round has been fired, the slide locks open signalling that the magazine is empty.

**F2. Ambidextrous safety decocking lever:** allows easier and quicker handling by left and right - handed shooters. (**Fig. 10**)

**F3. Special sights:** both front and rear sights are designed for swift target acquisition. To aid sighting under low light conditions, the sights are equipped with white inlays.

**F4. Grooved frame:** the front and back straps of the grip are longitudinally grooved to secure a firm hold even with wet hands, or under conditions of rapid, unaimed fire.

**F5. Reversible magazine release button (Model 92 FS Compact "Type M" excluded):** it can easily be assembled on the right side of the pistol for left handed shooters.

**F6. Checkered grips:** they ensure a better hold and give to the pistol a touch of el-

egance. Walnut checkered grips or black rubber grips are available on request.

**F7. Combat trigger-guard:** the trigger-guard is shaped and grooved to allow a functional rest of the index finger when shooting with two hand hold.

## G. SPECIAL MODELS

The G models (designed for the French “Gendarmerie Nationale”) feature a manual decocking lever only instead of the safety-decocking lever of the 92 FS. When the decocking lever is released, it automatically returns to the ready to fire position. There is no manual safety (**Fig. 4**).

**MODEL DS.** The new DS models are “double action only” pistols: the hammer always follows the slide forward to come to rest in the double action position (the hammer never stays cocked).

The hammer spur has been removed, and is flush with the rear of the slide. The manual safety lever on the slide provides the same function as it does on the 92 FS (**Fig. 3**).

**MODEL D.** The D models are also “double action only” pistols. They are identical to the DS models but without the manual safety (the lever has also been

eliminated).

**CENTURION MODELS.** These pistols offer the frame (and same magazine capacity) of the basic 92 FS model and the reduced length of the Compact version. Special G Centurion, DS Centurion and D Centurion models are available in some countries.

**COMPETITION CONVERSION KIT MODELS.** The standard model can be converted, with a special conversion kit, into a competition target pistol. The kit includes a 7.3" (185 mm) barrel with counterweight and elevated front sight, a fully adjustable target rear sight and ergonomic walnut grips. The kit comes, only with the standard pistol, in a special carrying case (**Fig. 5**).

**TARGET MODELS.** Designed to offer the ultimate performance in competition shooting, these models meet all U.I.T.S. standards for large caliber pistols (P.G.C.). They differ from basic 92 FS in the following aspects:

- 150 mm. barrel, with aluminum counterweight sleeve
- Fully adjustable target rear sight
- Ergonomic walnut grips, with “orange peel” anti-slip finish (**Fig. 6**)

## INOX MODELS

The Inox models feature the following parts made in stainless steel:

- The barrel
- The slide (including the extractor, the safety and the right-side manual safety lever)
- The trigger (and trigger pin)
- Slide stop lever
- Grip screws

The light alloy frame is anodized grey to match the other parts.

Some parts are chromium-plated matte (the hammer, the outside of the magazine, etc) and the rear sight is Bruniton coated.

A special model with gold inlays is also available (Inox Golden).

## DE LUXE MODELS

The new De Luxe models are available in three different versions: blued, engraved; silver-plated, engraved; gold-plated, engraved.

All versions have special smooth-finish walnut grips featuring an inlaid gold plate for initials, and come in an elegant cowhide covered case.

# GENERAL OPERATION

The series 92 Beretta pistols are semi-automatic firearms functioning on the short barrel recoil principle and using a falling block locking system.

Upon firing, the pressure developed by combustion gas recoils the slide-barrel assembly. After a short run of slide-barrel assembly, the locking block falls and releases the slide letting it recoil while the barrel stops against frame. The slide, during its rearward movement, extracts and ejects the fired cartridge case, cocks the hammer and activates the recoil spring.

Pushed by the recoil spring, the slide then moves forward feeding the next cartridge from the magazine into the chamber and causing barrel-slide locking.

The slide is designed to stay open after the last cartridge has been fired and ejected.

**⚠ Notice:** Some models are equipped with hammer half-cock position. It is not recommended to carry the hammer half cocked. This device is intended as an accidental discharge preventive hammer drop catch.

# TECHNICAL FEATURES AND DATA

	92 series			
<b>Models</b>	92 FS 98 FS 96	92 FS 96 Compact	92 FS 96 Centurion	92 FS Compact Type M
Overall Length mm/in.	217 - 8.5	197 - 7.8	197 - 7.8	197 - 7.8
Barrel Length mm/in.	125 - 4.9	109 - 4.3	109 - 4.3	109 - 4.3
Overall Width mm/in.	38 - 1.5	38 - 1.5	38 - 1.5	38 - 1.5
Overall Height mm/in.	137 - 5.4	135 - 5.3	137 - 5.4	137 - 5.3
Weight Unloaded (approx.) gr./oz.	975 - 34.4	910 - 32	940 - 33.2	875 - 30.9
Sight Radius mm/in.	155 - 6.1	147 - 5.8	147 - 5.8	147 - 5.8
Magazine Capacity rounds	15 - 11 (96)	13 - 9 (96)	15 - 11 (96)	8
<b>Models</b>	92 FS 98 FS 96 Inox	92 FS 98 FS 96 Deluxe	92 FS Compact Conv.kit	98 FS 96 Target
Overall Length mm/in.	217 - 8.5	217 - 8.5	277 - 10.9	242 - 9.5
Barrel Length mm/in.	125 - 4.9	125 - 4.9	185 - 7.3	150 - 5.9
Overall Width mm/in.	38 - 1.5	38 - 1.5	46 - 1.8	46 - 1.8
Overall Height mm/in.	137 - 5.4	137 - 5.4	147 - 5.8	137 - 5.4
Weight Unloaded (approx.) gr./oz.	975 - 34.4	975 - 34.4	1120 - 39.5	1050 - 37
Sight Radius mm/in.	155 - 6.1	155 - 6.1	230 - 9	176 - 6.9
Magazine Capacity rounds	15 - 11 (96)	15 - 11 (96)	15 - 11 (96)	15 - 11 (96)
<b>Models</b>	92 G 96 G	92 DS 96 DS	92 D 96 D	
Overall Length mm/in.	217 - 8.5	217 - 8.5	217 - 8.5	
Barrel Length mm/in.	125 - 4.9	125 - 4.9	125 - 4.9	
Overall Width mm/in.	38 - 1.5	38 - 1.5	38 - 1.5	
Overall Height mm/in.	137 - 5.4	137 - 5.4	137 - 5.4	
Weight Unloaded (approx.) gr./oz.	975 - 34.4	970 - 34.2	960 - 33.8	
Sight Radius mm/in.	155 - 6.1	155 - 6.1	155 - 6.1	
Magazine Capacity rounds	15 - 11 (96)	15 - 11 (96)	15 - 11 (96)	



**⚠ Notice: Competition Conversion Kit models: specifications of converted pistol.**

**CALIBER:**

- Models 92: 9 mm Parabellum.
- Models 98: 9 mm x 21 IMI.
- Models 96: .40 S & W.

**OPERATION:** Semi-automatic, short recoil of barrel.

**LOCKING SYSTEM:** Falling block.

**HAMMER:** Exposed hammer. Models DS, D: Without spur.

**ACTION:** Double and single action.

- Models DS, D: Double action only.

**RIFLING, PITCH:** R.H., 6 grooves. Pitch: 250 mm/9.8".

- Cal. .40 S & W: Pitch 400 mm./15.7".

**FRONT SIGHT:** Blade, integral with slide.

- Competition Conversion Kit models: High front sight dovetailed to counterweight.

**REAR SIGHT:** Notched bar dovetailed to slide.

- Models Comp Conv. Kit, Target: Fully adjustable.

**SAFETIES:** All models: automatic firing pin safety. When the trigger

is not pulled completely back, a blocking device secures the firing pin and prevents it from moving forward. Manual safety which separates the firing pin from the hammer, lowers the hammer, when cocked, and interrupts, the connection between trigger and sear.

- Models G: when the manual safety lever is released after having been activated to lower the hammer, it automatically returns to the ready-to fire position.
- Models DS: The manual safety separates the firing pin from the hammer and interrupts the connection between trigger and sear.
- Models D: Without safety.

**FRAME:** Light alloy. Sandblasted and Anodized black.

- Models De Luxe: Anodized black or Silverplated or Gold-plated.
- Models Inox: Anodized grey.

**SLIDE, BARREL:** Steel, phosphatized and Brunton coated. Inside chromium-plated barrel.

- Models De Luxe: Blued or silver-plated or gold-plated.
- Models Inox: Stainless steel, sand-blasted.

**GRIPS:** Plastic, checkered and sand-blasted matte. On request,

Walnut grips, checkered or anti-slip rubber grips.

- Mod. De Luxe: Walnut briar grips with gold plate for initials.
- Mod. Comp. Conv. Kit, Target: Ergonomic walnut grips with antislip finishing.

**SPECIAL FEATURES:** Mod. De Luxe are available in three versions: engraved black, engraved silver-plated, engraved gold-plated. All models are equipped with spare magazine, cleaning rod, ABS case. De luxe models are issued in a neat's leather case, cloth lined.

## LOADING AND FIRING

**! WARNING:** Always keep your finger away from the trigger whenever you do not intend to fire. Retract the slide to inspect the cartridge chamber to make sure it is empty.

### LOADING THE MAGAZINE

- To load the magazine remove it from the pistol by depressing the magazine release button (**Fig. 11**).
- Hold the magazine in the left hand. With your right hand place a cartridge on the follower in front of the lips, press down and slide the cartridge completely back under the lips (**Fig. 12**).
- Repeat until the magazine is fully loaded. Holes on the back or on sides of the magazine allow for visual counting of cartridges (**Fig. 7**).
- Do not try to force more than the maximum indicated rounds into the magazine.

### LOADING THE PISTOL AND THE CARTRIDGE CHAMBER

**! WARNING:** Always keep your finger away from the trigger whenever you do not intend to fire.

**⚠ Notice:** For the greatest insurance against accidental discharge due to inadvertent trigger pull, keep the manual safety engaged “ON” during loading or unloading.

- Engage the manual safety D2, if present, by pushing the safety decocking lever down all the way, so as to cover the red warning dot (**Fig. 13**). This safety lever rotation separates the firing pin from the hammer, lowers the hammer if cocked and interrupts the connection between trigger and sear.

**⚠ Notice:** Pistols model G and D have no manual safety. The G model has a decocking lever only which, when released, returns to the ready to fire position.

- Push the loaded magazine into the pistol grip completely to insure catch engagement.
- Grasping the slide serrations with thumb and index finger, fully retract and release the slide (**Fig. 14**) to load the chamber.

**⚠ WARNING:** THE PISTOL IS NOW CHAMBER LOADED, DECOCKED ("G" models are cocked), MANUAL SAFETY ENGAGED (if present). Always

keep your finger away from the trigger whenever you do not intend to fire.

**⚠ WARNING:** MODELS "G" ARE NOW CHAMBER LOADED AND COCKED. Lower the hammer rotating the decocking lever downward.

**⚠ Notice:** All Beretta 92 Series pistols described in this manual are equipped with an Automatic Safety D1, which prevents firing pin inertia breech protrusion. This safety is overcome only by trigger pull.

To replace the round which has been chambered from the magazine:

- Remove the magazine from the pistol by depressing the magazine release button.
- Insert one more cartridge into the magazine.
- Push the loaded magazine into the pistol grip completely to insure catch engagement.

**⚠ WARNING:** REMEMBER THAT YOU ARE HANDLING A LOADED WEAPON, WITH A LIVE ROUND IN THE CHAMBER. Keep your finger away from the trigger whenever you do not intend to fire.

**FIRING WHEN READY TO FIRE:**

- Aim the pistol and align front and rear sight on target.
- Release the manual safety (if present) by simply rotating the manual safety lever with a fully upward thumb pressure. The red warning dot can be seen when the manual safety is disengaged.
- Fire by squeezing the trigger.

**⚠ Notice:** Since the hammer is uncocked, the pull on the trigger will first cock the hammer and then release it. This firing mode is called **DOUBLE ACTION**.

The discharge will recoil the slide which, in turn, will eject the fired cartridge case, cock the hammer and activate the recoil spring. Then the slide will automatically close, feeding the next cartridge from the magazine into the chamber.

**⚠ WARNING: THE PISTOL IS NOW CHAMBER LOADED, COCKED AND READY TO FIRE AGAIN. Keep your finger away from the trigger whenever you do not intend to fire.**

- Squeeze the trigger to fire again.

**⚠ Notice:** Since the hammer is cocked, the pull on the trig-

ger simply releases the hammer. This firing mode is called **SINGLE ACTION**. After the first shot the pistol will fire always in the single action mode.

- If the hammer is fully-lowered, the safety OFF, and you want to fire the first shot by the single action mode, manually retract the hammer to its fully-cocked position. **WHEN READY TO FIRE**, squeeze the trigger.

**⚠ Notice:** Pistols model DS and D are designed to fire in the **DOUBLE ACTION** mode only. The hammer never stays cocked thus following the slide forward to come to rest in the **uncocked position**.

- When the last round has been fired the slide remains open (**Fig. 15**).
- To fire again remove the empty magazine and insert a loaded one.
- Press the slide catch, to close the slide and to load the chamber (**Fig. 16**).

**⚠ WARNING: THE PISTOL IS NOW CHAMBER LOADED, COCKED AND READY TO FIRE AGAIN. Keep your finger away from the trigger whenever you do not intend to fire, engage the manual safety (if present) and/or lower the hammer ro-**



Fig. 11

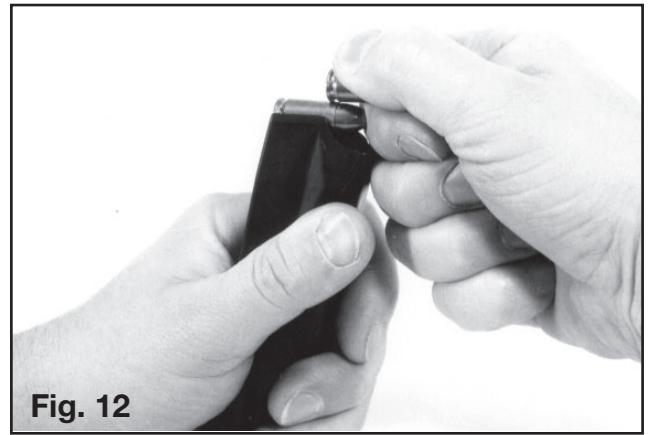

Fig. 12



Fig. 13



Fig. 14



Fig. 15



Fig. 16



Fig. 17



Fig. 18

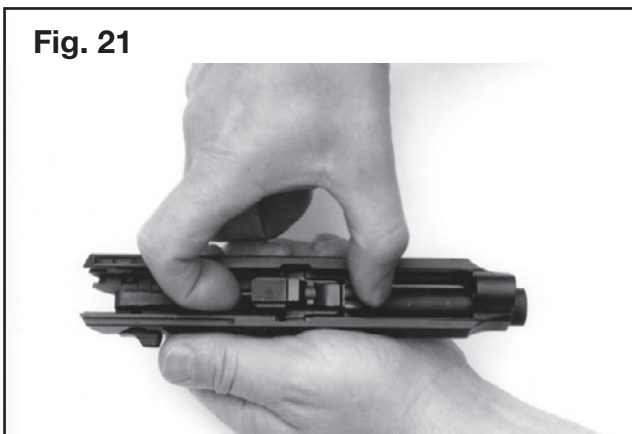
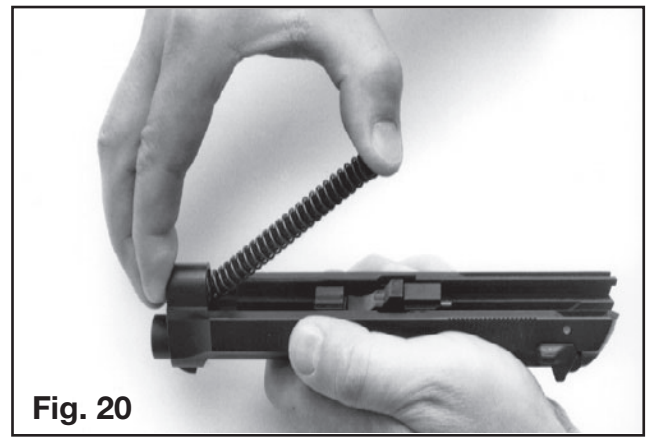

tating downward the decocking lever.

## UNLOADING THE PISTOL AND THE CARTRIDGE CHAMBER

- Engage the manual safety (fully down; red dot covered), if present and/or lower the hammer, if cocked, rotating the decocking lever downward.
- Depress the magazine release button as to remove the magazine from the pistol.
- Grasping the slide serrations with thumb and index finger, fully retract the slide to remove the chambered cartridge.
- WHEN SURE THE CHAMBER IS EMPTY AND THE CARTRIDGE HAS BEEN EJECTED, quickly release the slide.
- Model G pistols only: lower the hammer rotating downward the decocking lever.

## UNLOADING THE MAGAZINE

- To unload the magazine, grasp with one hand around the magazine box, bottom down and front end forward. With the tip of the thumb firmly press down on the cartridge rim and push. As the bullet moves forward, tip it slightly upward with the index finger.
- Repeat until the magazine is unloaded.

# MAINTENANCE

Every time the pistol is fired or at least once a month, cleaning and lubricating is recommended.

## FIELD STRIPPING

**! WARNING:** Make sure the pistol is unloaded. If not, unload it following the “UNLOADING THE PISTOL” procedure.

- Remove magazine by depressing magazine release button.
- Hold pistol in the right hand; with left forefinger press disassembling latch release button and with left thumb rotate disassembling latch clockwise until it stops (**Fig. 17**).
- Pull the slide barrel assembly forward with locking block, recoil spring and spring guide (**Fig. 18**).
- Slightly press recoil spring and spring guide (**Fig. 19**).

**! WARNING:** Spring and spring guide are under tension.

- Lift spring guide and recoil spring, letting the latter stretch slowly (**Fig. 20**).
- Press locking block plunger (**Fig. 21**).
- Take out the barrel locking assembly from slide (**Fig. 22**).

## NO FURTHER DISASSEMBLY IS RECOMMENDED UNLESS DONE BY A COMPETENT GUNSMITH

### Target and Competition Conversion Kit Models:

**⚠ Notice:** The counterweight sleeve G is locked to the barrel by the ring nut G1 and the locking screw G2 (Fig. 5, Fig. 6). Therefore, if separation of barrel from slide is required, it is first necessary to separate the counterweight sleeve from the barrel. (It is advisable to carry out this operation when pistol is assembled).

Proceed as follows:

- Remove magazine
- Unscrew the ring nut anticlockwise using the multiple spanner supplied and separate it from the barrel.
- With the Allen key of the multiple spanner loosen the locking screw (at least 2 turns)
- Pull forward the counterweight sleeve.

**⚠ Notice:** Slip out of barrel also the barrel - counterweight spacer.

- Follow the normal field stripping procedure.

## CLEANING AND LUBRICATING BARREL CLEANING AND LUBRICATING

- Spray the supplied brush with a good grade of CLP (cleaner lubricant-preservative) gun oil. Insert the brush into the barrel from the chamber and scrub the chamber and bore thoroughly.
- Dry chamber and bore by pushing a flannel patch through the chamber and bore with the brush. Keep changing the patch until it emerges clean.
- Clean the locking block with a cloth soaked in gun oil; if necessary use the brush supplied.
- Lightly oil the inside and outside of the barrel, passing through it a clean flannel soaked in gun oil. Lightly oil the locking block.

## SLIDE CLEANING AND LUBRICATING

- Clean slide with a cloth and/or brush soaked in gun oil, paying special attention to the breech face and extractor, slide rails and underside of breech. Wipe clean.
- Lightly oil the slide. Drop a few drops of oil around the extractor, firing pin block and safety and finger activate the parts to



insure oil penetrations and free movement.

### **RECOIL, SPRING AND SPRING GUIDE LUBRICATING**

- Lightly oil recoil spring and spring guide with gun oil. After
- Long use it may be necessary to first clean with gun oil and the brush supplied.

### **FRAME CLEANING AND LUBRICATION**

- WITH OIL SOAKED RAG OR BRUSH, CLEAN ALL AREAs covered by gunpowder residue and field dirt.
- Wipe clean and lightly lubricate rails and moving parts. Be sure to oil the disassembling latch, magazine catch, slide stop, trigger system, hammer, sear, and the levers in front of the hammer.

### **MAGAZINE CLEANING AND CARTRIDGE ROTATION**

- Be sure to thoroughly clean the magazine(s). After cleaning, wipe with a lightly oil moistened rag.
- If the pistol is carried chamber and magazine loaded, it is important to periodically unload all magazines for cartridge inspection.

### **Target and Competition Conversion Kit models:**

After having cleaned and lubricated the pistol, if necessary lean and lightly oil the inside of the counterweight sleeve.

### **ASSEMBLY**

Assemble following the Field Stripping procedure in reverse order. It is advisable to pay attention to the following points:

- Engage safety
- The barrel should rest perfectly flush against the slide (the extractor must lodge in its groove in the barrel)
- The locking block lugs should rest in their housing (the locking block plunger should protrude from the barrel base).
- The recoil spring guide head should lodge in the center of its groove in the locking block.
- When rotating disassembling latch, the slide should be in the closed position (aligned with or beyond the rear side of frame).

### **Target and Competition Conversion Kit models**

To assemble the counterweight sleeve (with barrel assembled to slide):

- Check that the barrel-counterweight spacer is placed in position
- Insert the counterweight sleeve

on the barrel and screw the locking screw to the end with the Allen key of the multiple spanner supplied, taking care that the counterweight sleeve is aligned with the slide.

- Screw on the ring nut and lock it using the multiple spanner supplied.

## HOW TO ASSEMBLE THE ADJUSTABLE REAR SIGHT

### COMPETITION CONVERSION KIT MODEL

This operation should be carried out by a gunsmith.

- With a suitable hammer and the aluminum plate supplied push the fixed sight out of the slide slot (operating from the right to the left side of the slide)
- Insert the dovetail base of the adjustable rear sight into the slide slot (from the left to the right side of the slide).

** Notice: The slide lock slot is conical. Respect the right way of extraction and insertion of the rear sight.**

When the adjustable rear sight base is centered in the slide, lock it in position screwing the two dowels to the end, without forcing, using the Allen key supplied.

** Notice: To approach the dowels, it is necessary first to unscrew to the end the upper rear sight screw. Be careful not to lose the springs.**

## ADJUSTING THE REAR SIGHT

### Target and Competition Conversion Kit models

Adjustment of rear sight is done aligning front and rear sight on the mark (as shown in the ill, below).

To modify the rear sight adjustment, proceed as follows:

### ADJUSTMENT FOR ELEVATION (UP).

To raise the point of impact on target, turn the upper screw anti-clockwise using a suitable screwdriver (follow the arrow marked on the sight). Proceed one sector (click of the screw) at a time so that the finest adjustment is obtained.

To lower the point of impact, proceed in reverse.

### ADJUSTMENT FOR WINDAGE.

To move the point of impact on target to the right, turn the side screw clockwise following the arrow marked on the right side of sight. Proceed one sector (click of the screw) at a time so that the finest adjustment is obtained.

To move the point of impact to the left, proceed in reverse.

## HOW TO REVERSE THE MAGAZINE RELEASE BUTTON

(FOR LEFT-HANDED SHOOTERS)

(Not possible on the Type M versions)

This operation should be carried out by a gunsmith.

- With a suitable screwdriver unscrew and remove the grips.
- Press the back (flat side) of the magazine release button down and away. The magazine release assembly will then drop out.
- Reverse the magazine release assembly and insert the button (grooved side) in position tilting it slightly.
- Holding the button (grooved side) of the magazine release assembly firmly in place, press its flat side and push it until it clicks into place. The operation is done correctly when the magazine slides easily into its housing.
- Replace grips with screws.

# TROUBLESHOOTING

MALFUNCTION	PROBABLE CAUSE	REMEDY
Mis-introduction of a cartridge into the chamber	Defective cartridge	Inspect and replace cartridge
Mis-fire	Defective cartridge	Pull the trigger once more or replace cartridge
Mis-extraction or defective extraction	Dirty cartridge chamber	Clean and lubricate cartridge chamber
	Defective or dirty ammunition	Replace or clean cartridges
	Dirt under the extractor	Clean the extractor seat

**⚠ WARNING:** Do not attempt to make repairs to any firearm without proper knowledge or training. Do not alter parts or use substitute parts not made by Beretta. Any necessary alterations or adjustments to the operating mechanism should be performed by the Manufacturer.

**⚠ WARNING:** Do not attempt to alter the internal parts of your pistol's firing mechanism. Altering internal parts can cause unsafe condition.

# AMMUNITION

Using good quality ammunition combined with preventive maintenance will make the pistol perform flawlessly through years of service. To prevent malfunctioning always visually inspect each cartridge for external damage before loading.

The pistol is designed and tested to withstand continued shooting with all brands and types of commercial ammunition manufactured to standard (C.I.P., S.A.A.M.I.®, etc.) specifications. We do not recommend extended use of +P, +P+ or submachine gun ammunition because the chamber pressure may reach or exceed proof load pressure decreasing the major components service life expectancy.

The warranty does not cover the use of reloaded and/or hand loaded ammunition.

**⚠ WARNING:** If using reloaded cartridges containing solid lead bullets, take the following precautions:

- DO NOT use any ammunition on which the case mouth is CRIMPED into the bullet.

- Make sure the bullets are of the right caliber size according to international specifications (C.I.P., S.A.A.M.I.®, etc.).
- Avoid the use of bullets having sharp contour step close to case mouth.
- Lead bullets have a tendency to cause bore leading which may dramatically increase the discharge pressure.
- Make sure to remove all chamber and bore lead accumulation after each shooting.
- DO NOT ever shoot cartridges with jacketed bullets through a barrel previously fired with lead bullets before the bore is thoroughly delead.
- Repeated reloading will structurally weaken the case head/web section which may result in case rupture.

## DRY FIRING / "DUMMY" ROUNDS

If you want to practice aim and trigger pull, insert a FIRED cartridge case or "DUMMY" cartridge in the chamber to cushion the fall of the firing pin and eliminate the chance of firing pin breakage.

Hammer fall in connection with the normal use of the manual safety-decocking lever DOES NOT cause firing pin breakage.

Your dealer can supply different “DUMMY” cartridges:

** Notice:** “DUMMY” cartridges with spring loaded “Primer” are excellent but expensive. “DUMMY” cartridges with solid heads are good for loading/unloading and dry firing practice.

** Notice:** “DUMMY” cartridges with empty primer pockets are good for loading/unloading practice but **DO NOT** protect the firing pin when dry firing.



-----

-----

-----

-----

-----

-----

-----



-----

-----

-----

-----

-----

-----

-----

-----

-----

-----

-----

-----

-----

-----

**3rd ISSUE: February 2021**

92  
PISTOL  
USER MANUAL



FABBRICA D'ARMI P. BERETTA S.P.A.  
VIA PIETRO BERETTA, 18  
I 25063 GARDONE VAL TROMPIA, BRESCIA, ITALY

[BERETTA.COM](http://BERETTA.COM)

C60373