

Stealth Cam STC-AD3 User's Manual



Toll Free Customer Support 1-877-269-8490
www.stealthcam.net

STC-AD3

For Customer Service or Warranty Information Call Toll Free

877-269-8490

Stealth Cam, LLC
P.O. Box 211662
Bedford, Texas 76095
www.stealthcam.net

Stealth Cam Limited Warranty

Your Stealth Cam is covered by a One Year Limited Warranty on parts & labor from the date of purchase. The warranty covers defects in workmanship & materials. The warranty does not apply to units, which have been damaged or abused intentionally or unintentionally.

Tampering with or altering the unit will void the warranty. Any unauthorized service will void warranty. Original sales receipt must be produced for any warranty service. Questions call 877-269-8490

Manual Contents

Warranty	2
Camera overview	4
Camera kit contents	8
Battery and memory installation	9
Set up and programming	13
Using the camera	24
Manual shooting mode	32
Viewing and deleting images	34
Using external power	42
Memory compatibility chart	43
Technical specs	44
General information	48

STC-AD3

Camera overview

Front housing image with major parts indication.

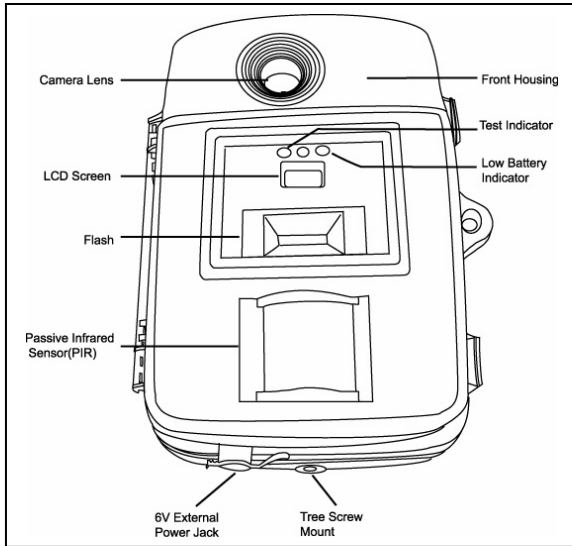

STC-AD3

Open view image with major parts indication

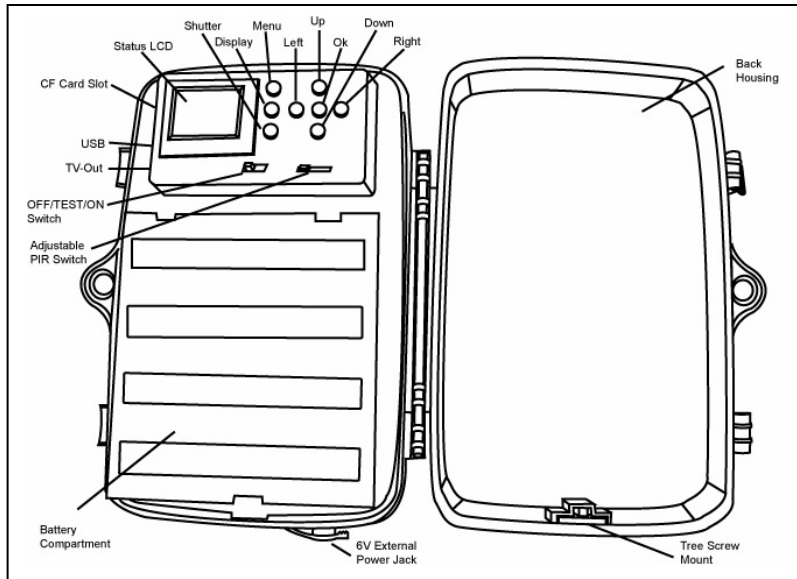

STC-AD3

Side view with major parts indication

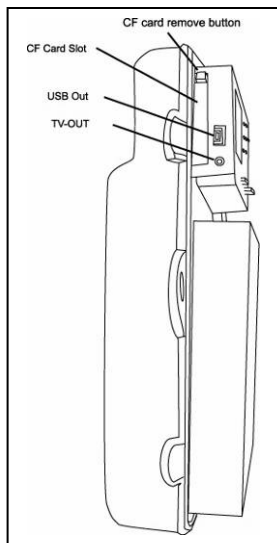

STC-AD3

Picture / Image Capacity

CF card	High	Low	AVI
16MB	30	120	20
32MB	60	240	40
64MB	120	480	80
128MB	240	960	160
256MB	480	1920	320
512MB	960	2048	640

NOTE: Picture / Image Capacity Chart provides approximate number of images or AVI movies based on resolution setting and the size of memory card. These figures may vary depending on the amount of detail in the image.

STC-AD3

Camera kit contents

- Model STC-AD3 Digital Scouting Camera
- CDROM (Contains Lover's Eye image editing software and camera driver)
- User Manual
- 1.2M USB cable
- 1.5M TV out cable for TV (RCA Jack)
- 1.5M TV out cable for handheld TV (Mini Jack)
- Strap
- Tree screw with nut
- Washer x 2
- Lock plate

Battery & memory installation

Warning: Do not use different Voltage lead acid battery other than the one specified in this section. Doing so will damage the camera and will void the warranty.

The Stealth Cam STC-AD3 Advanced Digital Scouting Camera is designed to operate using two different types of battery power options.

NOTE: Always have camera in OFF position when installing or removing batteries.

Batteries “D” cell

The internal battery compartment accepts 8 “D” cell batteries. Be sure to use high quality brand name alkaline batteries. Install batteries in correct polarity (+/-) as noted inside battery compartment.

STC-AD3

6V Lead Acid external battery

The STC-AD3 is equipped with an external power jack designed to accept a barrel plug cable to attach to a sealed lead acid battery. (Sold separately) Battery cable and complete 6V Lead Acid battery kits are available wherever Stealth Cam scouting cameras are sold or call toll free 877-269-8490. Only Stealth Cam external battery accessories are recommended.

- Make sure the camera power switch is OFF.
- Insert the battery pack plug into the DC 6V jack of the bottom of camera housing
- Turn the camera power on.

❖ ***Please make sure the voltage and polarity (+/-) are correct before connection. Incorrect voltage or polarity (+/-) will damage the camera.***

www.stealthcam.net

Toll Free 877-269-8490

STC-AD3

Memory Options

Your STC-AD3 camera is equipped with 32MB built in flash memory. The camera is also equipped with an expandable media card slot capable accepting up to 512MB Compact Flash card (sold separately). With no memory card inserted into the slot, the camera will use the built in 32MB memory. If a Compact Flash card is inserted into the slot then the camera will bypass the built in memory and utilize the compact flash memory. The front counter display will show the number of images on the built in memory unless the expansion card is inserted at which point the counter will only show the number of images in the expansion card.

Inserting CF card

Make sure camera is in the OFF position when ever adding or removing memory.

- Insert CF memory card in to the CF card slot completely and in the correct direction as shown by the sticker located at the top of the housing.
 - To remove the CF memory card by press the eject button which is on the upper of the card.
- ❖ ***Compact flash cards must be clean (no images from other sources), if you are using the CF card from other cameras, please make sure to format the CF card prior use in the camera. New cards are good to use straight from the package.***
- ❖ **To ensure proper CF card formatting, insert the CF card into the card slot and use your STC-AD3 cam to format the CF card. Please follow the steps in Section “Format Memory” on page 17 to format the CF card.**



Set up and Programming

Internal LCD screen displays the camera program status as you go through each program setting.





- **Time out:** To set the amount of time in minutes the camera will sleep between PIR triggering.
- **Flash Control:**
 - Auto: In low light conditions the flash will activate automatically. ⚡^A
 - Flash Off: Turn off flash light
- **Capture mode:** The capture mode that you have selected.
 - **1P:** Single image capturing per PIR triggering.

STC-AD3

- **2P:** Two images continuous capturing per PIR triggering.
- **3P:** Three images continuous capturing per PIR triggering.
- **Video:** Taking 10 seconds video per PIR triggering.
- **Manual:** Manual capturing by pressing shutter button to operate. (use as point and shoot camera or video camera under Test Mode)
- **Image Resolution:** The resolution selection that you have selected.
 - **2048 x 1536:** Select this option to capture a high image resolution. 
 - **1024 x 768:** Select this option to capture a low image resolution. 
 - **320 x 240** Video resolution: This is the resolution during video capturing.
 - **Image Quality:** The quality selection that you have

STC-AD3

selected.

- ◆ One star = Low Quality ★
- ◆ Two stars = Normal Quality ★★
- ◆ Three stars = Fine Quality ★★★
- **Batteries Status:** It shows the battery status.
 - **Full:** It shows the batteries are full. 
 - **Half:** It shows the batteries are half. 
 - **Low:** It shows the batteries are low and front battery indicator will be on also. 
- ***When the camera has detected low batteries, (Both set of batteries are lower than 4.5 +/-0.2Volts) the camera unit will power off within 30 seconds automatically. Please replace with new batteries; otherwise the camera will not work properly.***

STC-AD3

Precaution: When replacing batteries, replace the upper 4 batteries in the battery compartment with new ones first. **After you done this then replace the lower 4 batteries.** Removing all 8 batteries at one time will result in the loss of date / time setting.



- **Date and Time:** It shows the date and time that you have set.

Programming the Stealth Cam STC-AD3

Slide the power switch to TEST position. You will hear one initial beep. Wait for the 2nd beep before you press the MENU button. Once you hear the 2nd beep, you are ready to program the camera. Press MENU button once to start your programming sequence.

Manual Capture Mode

To capture images using manual shutter button

The camera icon or movie icon will be blinking  

Press Left/Right button to select between manual Camera capture mode or manual Movie capture mode

Press OK to confirm setting and the icon will be freeze

Press Menu to exit setting (***see page 31 for manual mode operating instruction***)

Press Up button to change the last setting or Down button to continue with the next setting.

Format Memory

To erase images stored in internal memory or to format a CF card.

Basket icon will be blinking 

Press OK to confirm format the memory

STC-AD3

Press OK again to start formatting process (the time it requires to format the memory will very depend on the size of the CF card memory capacity.)

Once you hear the beep sound, it indicates formatting process is complete.

Press Menu to exit Setting

Press Down button and scroll through the program icon to resolution setting and continue with the next setting.

Flash Control

Default setting is set on auto Flash.

Auto Flash icon will show on top right screen



STC-AD3

To turn off Flash light, Press Right button once. The flash icon will disappear.



Resolution

The Resolution icon will be blinking 

Press Left/Right button to select high resolution (2048 x 1536) or low resolution (1024 x 768)

Press OK to confirm setting and the icon will be freeze

Press Menu to exit setting

Or press Up button to change the last setting or Down button to continue with the next setting.

STC-AD3

Quality

The Quality icon will be blinking 

Press Left/Right button to select between Fine – Normal – Low quality

One star = Low quality

Two star = Normal quality

Three Star = Fine quality

Press OK to confirm setting, the icon will be freeze

Press Menu to exit setting

Or press Up button to change the last setting or Down button to continue with the next setting.

TV (NTSC/PAL)

The PAL or NTSC icon will be blinking 

Press Left/Right button to select PAL or NTSC.

STC-AD3

(NTSC is the correct setting for all North America. Your Stealth Cam STC-AD3 comes pre-programmed for NTSC.)

Press OK to confirm setting and icon will freeze

Press Menu to Exit

Or press Up button to change the previous setting or Down button to continue with the next setting.

Date Time setting Date
 Time

This camera uses the 24hr military time format.

Press O.K. button to enter into setting mode.

Set date and time

The date will be shown on the LCD with the setting digit blinking.

Month - Day - Year ↔ Hour - Minute - Second

1. Press Up/Down button to select the appropriate month
2. Press Right button to select the day setting
3. Press Up/Down button to select the appropriate date

STC-AD3

4. Press Right button to select the year setting
5. Press Up/Down button to select the appropriate year
6. Press Right button to enter the time setting
7. Press Up/Down button to select the appropriate hour
8. Press Right button to select minute setting
9. Press Up/Down button to select the appropriate minute
10. Press Right button to select the second setting
11. Press Up/Down button to select the appropriate second

At the end of time setting, press OK to confirm the date/time setting and exit the setting menu.

NOTE: If you press Menu before pressing the OK button, you will exit the setting menu without confirm the date time setting

Set the Capturing sequence. *The Stealth Cam STC-AD3 can be programmed to shoot 1-3 pictures per triggering or 10 seconds of video.*

Stealth Cam Setting

Press Menu button to scroll through the program setting icon until the setting with number of photo digit blinking.

Press Left/Right to set the number of photo to be taken each times as sequence 1P – 2P – 3P – AVI. If you do not wish to change the picture setting, press Down button to proceed to Time Out Setting.

AVI will display “Au”; it will record a 10 sec AVI movie

Press OK to confirm the number of Photo setting

After setting the number of photo each time, press Down button to select time interval in minute (1-60 min) to active PIR detection for ON. Time digit will be blinking.

Press Right button to increase the time interval by one min

Press Left button to decrease the time interval by one min

Press OK to confirm

Once all settings have been completed press the MENU button to return to CAMERA STATUS screen.

Using the camera

Once all program setting has been completed your Stealth Cam is ready for field use. Slide the power toggle switch from Test setting mode to Off position if you are not ready to use the camera or slide to On position if you are ready to begin scouting.

- ❖ *Please note that when you power off the camera, the front LCD counter will remain on. This is normal. Do not be alarmed.*

Getting started

Mounting the Camera. It is recommended to mount the camera 4~5 ft off the ground with the camera pointed at a slight downward angle. Be sure to avoid mounting the camera facing east or west as the rising and setting of the sun could produce false triggers

STC-AD3

and overexposed images. Clear branches and other debris away from the front of the camera so as not to block the camera lens or PIR sensor.

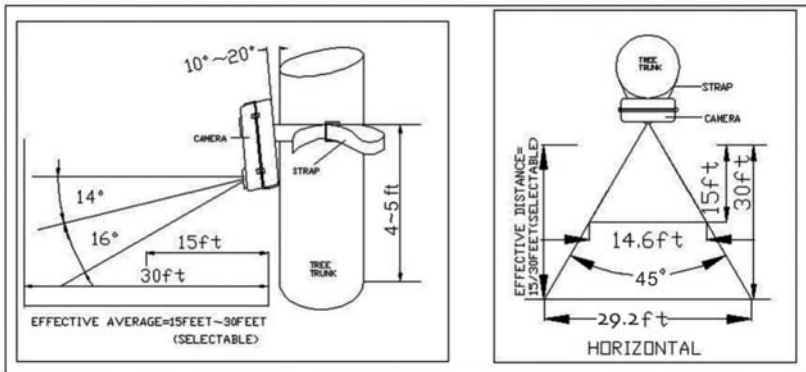

PIR Cover Area Diagram

STC-AD3

Mounting the camera with the supplied Tree Screw

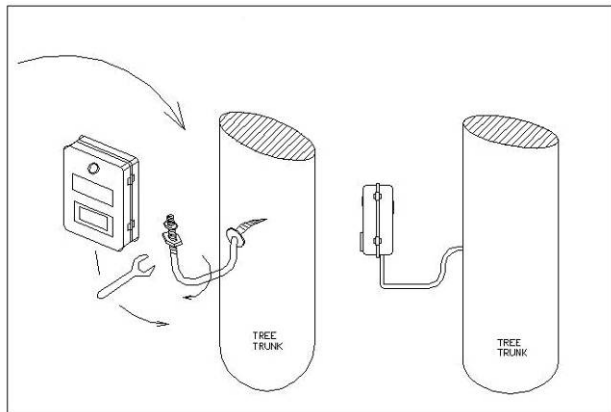

- Hand twist the screw into the tree or post at the desired position.
- Attached the camera to the screw by turning the camera onto the mounting screw to the desired position.
- Tighten the stabilizer nut.

STC-AD3

- ***Attached camera to tree screw. Do not over tighten as this may cause damage to camera housing. Using the supplied nut and washer, tighten to the bottom of camera for greater stability.***

Mounting the camera with the supplied strap

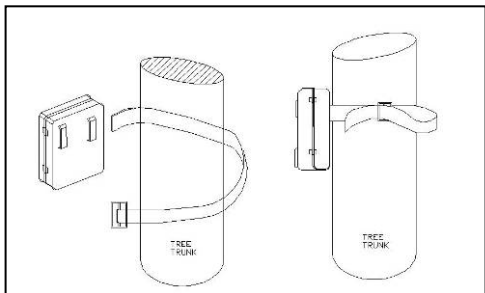

- Insert the strap through the strap slots on the rear housing.
- Wrap the strap around the mounting surface. Secure the strap

STC-AD3

and tighten the buckle in order to secure the camera.

Stealth Cam offers a Security Lock Bracket for uses exclusively with this camera. See included accessory card or call toll free 877-269-8490.

- ❖ ***In order to obtain proper weather resistance, please make sure that both door latches are securely locked in place.***

Adjust the PIR coverage distance.

- This Stealth Cam offers the user a variable PIR distance.
- The PIR dial has a near to far designation.
- NEAR is approximately 15ft and FAR is approximately 30ft.
- Select the desired coverage distance. (see PIR Coverage Diagram on page 24 for reference.)

STC-AD3

Testing the camera coverage area

One of STC-AD3 Cam's many features is the ability to test the coverage area.

- After mounting the camera, open front housing and slide the power toggle switch to TEST.
- Close the front housing.
- Walk around in the front of the camera to see if you have mounted camera in the proper position. A green indicator light on the front will blink on when you have intruded the coverage area.
- Adjust the camera position as needed and repeat testing until the desired coverage area is achieved.
- When you have completed the testing the coverage area, open the front housing and slide the power toggle switch from TEST to ON position. This will exit the test mode. The camera will then enter count down mode for 1 minute and front green indicator will start continuous blinking giving you one minute to leave the coverage area. Then the camera will enter PIR detection mode.

STC-AD3

Using the camera in PIR detection mode

- Mount the camera to tree or other sturdy object using either two supplied tree screw or mounting strap (Please refer to the mounting suggestions section in this manual)
- Open the front housing and move the switch to the ON position.
- The camera's green test light will begin blinking and enter count down mode. This is your indication to leave the coverage area within one minute.
- After one minute the camera will take between 1~3 pictures or a 10 seconds AVI video based on your program setting. The camera will then time out between 1 ~ 60 minutes also based on your setting.
- ❖ ***The time between motion detection and the camera taking the pictures may vary due to lighting conditions, charging of the flash, program setting and battery power level.***
- ❖ ***The flash light will only activate in low light conditions when set in Auto Flash.***
- ❖ ***When the camera is set to AVI capturing, the 10 seconds***

STC-AD3

clips will only turn out well in good daytime lighting conditions.

- ❖ ***When using the AVI function, the camera cannot use the flash. Time/Date stamp will not appear on the AVI video clips.***

Manual shooting mode

Using manual shoot option for Camera mode

- Slide the power toggle switch to TEST position. Wait for 2 beeps. Picture icon will show as default on LCD screen to indicate Camera mode. 
- Once you hear the 2nd beep, you may point the camera in the direction where you want to capture the image and press SHUTTER button once. You will hear two fast beeps after you press the SHUTTER button. This indicates the image has been captured and the LCD counter on the front of the housing will update the number of images in memory.
- When taking night time pictures allow approximately 7 seconds between shots to allow the flash to charge. In case of low battery power, it will take longer to charge the flash between pictures.

STC-AD3

Using manual shoot option for AVI mode

- Slide the power toggle switch to TEST position. Wait for 2 beeps.
- Once you hear the 2nd beep press the MENU button. The Camera icon will flash.
- Press RIGHT button to select manual Movie capture mode. Movie icon will show on LCD screen to indicate AVI mode. 
- Press OK to confirm setting and the icon will freeze.
- Press MENU to exit setting.
- You may now point the camera in the direction where you want to capture the video and press SHUTTER button to start the video recording.
- Press the SHUTTER button the 2nd time to stop video recording.

(Note: if you forget to press the SHUTTER button the 2nd time to stop video recording, it will record the video indefinitely until the memory capacity is full or until you power off the camera.)

STC-AD3

Viewing and deleting the images

The STC-AD3 cam offers the user three different options for viewing the images. The external LCD display screen on the front housing will show the number of images in memory

The instructions below are based on starting from a camera that is turned off.

Viewing the image on a handheld LCD TV video monitor (cable included)

- Attach the appropriate cable to the video out jack on the camera. Insert the other end into the video in jack on handheld LCD TV monitor. Turn on the TV monitor and slide the camera power toggle switch to TEST. Wait for Camera image to show up on monitor.
- Press the OK button on the camera. This will display the last image captured.
- Using the LEFT and RIGHT buttons to select the image you wish to view. Image number and total number of image in the

STC-AD3

memory will display on the center bottom of the screen.

- Once you have selected the image you wish to view, press the UP button. This will magnify the image on the screen.
- Using LEFT/RIGHT/UP/DOWN button, you can move the image to display different area of the image.
- To return to the image selection view from the magnified image screen press the OK button.

Viewing the images on your home TV equipped with an RCA input jack. (Cable included)

- Attach the appropriate cable to the video out jack on the camera. Insert the other end into the RCA video in jack on the TV. Turn on the TV and slide the camera power toggle switch to TEST. Wait for Camera image to show up on monitor. **Make sure to switch to VIDEO IN mode on your TV. (See your TV owner's manual for directions.**
- Press the OK button on the camera. This will display the last image captured.

STC-AD3

- Using the LEFT and RIGHT buttons to select the image you wish to view. Image number and total number of image in the memory will display on the center bottom of the screen.
- Once you have selected the image you wish to view, press the UP button. This will magnify the image on the screen.
- Using LEFT/RIGHT/UP/DOWN button, you can move the image to display different area of the image.
- To return to the image selection view from the magnified image screen press the OK button.

Viewing AVI Clip on hand held TV monitor or home TV

- Follow the cable attaching instruction listed in hand held TV monitor or home TV described in previous section.
- Press the OK button on the camera. This will display the last image captured.
- Press LEFT / RIGHT button to scroll through the images in memory. An AVI motion clip image will have a move icon showing on the upper left hand corner of the image.

STC-AD3

- Press SHUTTER button to play back the AVI motion clip
- To return to image selection view, press LEFT / RIGTH button at the end of the AVI clip.

Viewing images by computer download

The Stealth Cam STC-AD3 advanced Digital Scouting Camera is a plug and play USB storage device. This means users of Windows 2000 / ME / and XP operating system need not install the camera driver. This camera is not MAC compatible. The disc included in this package contains the camera driver for older operating systems as well as Lover's Eye photo imaging software for image enhancement and manipulation.

Attention:

The software CD-ROM packaged with the camera is designed for PC's only (not MAC compatible). Playing this CD-ROM on a stereo or CD player may cause damage to it.

Software installation

- Unplug the USB cable from PC.
- Insert the CDROM in CD driver of your PC.
- The auto-run program will execute.
- Follow the instructions shown on screen from your PC to completely install the driver and application program.
- Restart windows.
- Successful installation will create “Lover’s Eye” photo imaging icon on you desktop.
- Connect your camera to the PC using the USB cable provided, the PC will recognize the new device and set UP the configuration of the PC automatically.
- ***NOTE: Users of Windows 98SE or earlier must install camera driver prior to connecting the USB cable.***

STC-AD3

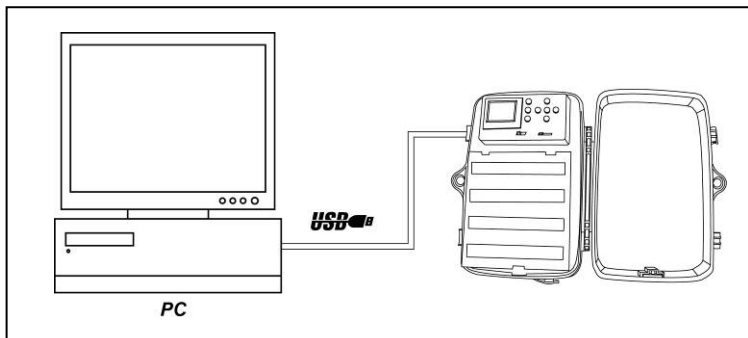

- If your computer doesn't run automatically, please click "Start" button and choose "Run", and then browse the CD drive and click "Setup".
- Operation manual of Lover's Eye Photo Imaging software is contained on the provided CDROM.

Viewing the images on your computer using the provided software

Please refer to Installation section on above to install the software and application program properly.

STC-AD3

- Slide the power switch to test location.
- To view the images simply plug one end of the USB cable into an available USB port on your computer.
- Plug the other end of USB cable into the camera. The camera will automatically power ON and display a USB icon on the LCD screen.
- At the same time, your computer will recognize the camera as mass storage device and found under MY COMPUTER.

Deleting images

At any time while viewing images on the Handheld TV or Home TV you may delete images one at a time or all at once.

- While viewing images in normal view press MENU to enter the DELETE menu.
- Using the LEFT and RIGHT buttons to choose desired function. Delete 1 or Delete ALL.
- Press OK to enter delete mode.

STC-AD3

- Press OK again to confirm deleting image or MENU to exit without deleting images.

After selection has been made the screen will go back to image view mode.

Using the external power

This Stealth Cam is designed to be used with an optional external 6V lead acid battery kit. (Sold separately)

- Make sure the camera is turned to OFF.
 - Insert the barrel plug cable to the external power jack at the bottom of the camera.
- ❖ ***Make sure to install the cables in correct polarity (+/-) for the lead acid battery. Incorrect voltage or polarity (+/-) will result in damaging the camera.***

STC-AD3

CF Card Compatibility Chart

The following cards have been tested and approved for use in the STC-AD3

Digital Media	256 MB
Viking	256 MB, 512 MB
PNY	256 MB, 512 MB
San Disk	64 MB, 128 MB, 256 MB, 512 MB
Kingston	512 MB
MUSE	64 MB, 128 MB

Technical Specifications

System Requirements and Compatibility

- Windows 98SE (with driver), 2000/NT, Me, XP.
 - Pentium 200MHz or above.
 - 64MB SDRAM or above.
 - VGA Video Card with 32MB RAM for minimum, Color 16 bit or higher.
 - An available CDROM driver and an available USB Port.
 - 300 MB free hard disc space.
 - Optional: Windows compatible sound card, Microphone and speaker.
- ❖ ***If you have any questions regarding your PC specifications please call your PC manufacturer.***

STC-AD3

Camera Features and Specification.

- Image sensor: 3.0 mega-pixels RGB color.
- Built in 1.8" B&W LCD display.
- Built in 32MB flash memories for image storage
- External memory support: CF memory card up to 512MB
- Resolution Options: High (2048 x 1536), Low (1024 x 768)
- Quality Options: Low, Normal, Fine
- 4 Capturing Options:
 - ❖ Manual : Single or Video (AVI)
 - ❖ PIR activate : 1,2,3 Continuous or Video (AVI)
- Image performance for video stream: 10fps in 320 x 240 pixels, approx 10 seconds per section.
- Auto white balance and auto expose.
- Flash light strobe Auto / Off control.
- Real time clock for date and time stamping.

STC-AD3

- 4 digits LCD Image counter.
- Battery low indicator.
- Green Test LED indicator
- TV out support for NTSC and PAL system.
- Focusing: 3M to Infinity.
- High precision 3P glass lens with IR coating.
- Effective viewing Angle: 52 deg.
- PIR detection angle 45 deg.
- Adjustable PIR detection range up to 9 meter.
- Low power consumption:
 - Standby current: < 5 mA
 - Capture current <250 mA
- Interface type: USB 1.1.
- Power: D size alkaline Batteries x 8. (not included)

STC-AD3

- Ext power: 6 volts battery pack. (not included)
- Image format: Standard JPEG. And Motion JPEG (AVI)

General Information

Storing conditions

- Operating Environment: 14 to 104 deg F (-10 to 40 deg C). 20-85% relative humidity, non-condensing.

Special care instructions!!

- The camera is designed to be weather resistant. Never attempt to immerse the unit to water or any other liquid. This will damage the unit and void the warranty.
- Use a soft lens cloth for cleaning lens. Avoid touching lens with fingers.
- Remove dirt or stains with a soft cloth dampened with water or neutral detergent. Keep the camera in a dry and cool dust-free environment or container when it is NOT used.
- Take the batteries out, when the camera is NOT to be used over a long period.
- Avoid dropping the camera on to hard surfaces. Do not disassemble the camera.

STC-AD3

- Do not mix new and old batteries.
- Do not open the camera for unauthorized service. This could cause serious damage to the unit and will void the warranty.

This camera is a precision electronic device. Do not attempt to service this camera yourself, as opening or removing covers may expose you to dangerous voltage points or other risks.