

Owner's Manual

Instruction Book for:

MODEL 552™
AUTOLOADING RIMFIRE RIFLE &
MODEL 572™
PUMP ACTION RIMFIRE RIFLE

IMPORTANT!

This manual contains operating, care, and maintenance instructions. To ensure safe operation, any user of this firearm must read and understand this manual before using the firearm. Failure to follow the instructions and heed the warnings in this manual can cause property damage, personal injury, and/or death.



This manual should always accompany this firearm, and be transferred with it upon change of ownership.

WARNING! Keep this firearm out of the reach of children, unauthorized individuals, and others unfamiliar with safe handling of firearms.

- PAGE 2.....THE TEN COMMANDMENTS OF
FIREARM SAFETY
- PAGE 7.....IMPORTANT PARTS OF THE FIREARM
- PAGE 10.....HOW TO LOAD AND UNLOAD
- PAGE 13.....LUBRICATION AND MAINTENANCE
- PAGE 20.....HOW TO OBTAIN PARTS AND SERVICE

Remington®



Model 572™
Shown

A Tradition of Performance and Safety.

In 1816 Eliphalet Remington was confident he could make a flintlock that was as good or better than any he could buy. His confidence was well founded. The barrel he handcrafted set a new standard for firearm accuracy and spawned generations of products that have made Remington® Arms America's leading gunmaker. While performance and style are certainly hallmarks of Remington firearms, one factor ultimately drives their performance. Safety. Eliphalet Remington never lost sight of the fact that his rifles were potentially lethal and could kill someone if handled improperly. And after more than 180 years the same holds true for any firearm, including your new Remington. Eliphalet Remington's first flintlock launched a proud tradition of accuracy and responsibility.



Eliphalet Remington's first flintlock launched a proud tradition of accuracy & responsibility.

Safety is Critical to Performance.

A superbly crafted gun is only as good as the hands that hold it. You can never be too careful. Shooting accidents are often caused by careless oversights such as failing to control the direction of the muzzle, failing to fully engage the safety, leaving ammunition in the chamber or using improper loads. These oversights can result in the destruction of life, limb or property. There's no calling back a bullet once it's been fired, so it's critical that you know the principles of safe gun handling and storage before you ever take your new Remington firearm out of the box.

The proper use and performance of your firearm depends on correct assembly and maintenance, so it's critical that you familiarize yourself with the information in this instruction book. Even if you're a veteran shooter with a collection of Remington firearms, take the time to read this literature. Not all firearms are the same. That means the first step in safe handling is to learn the features and requirements of your new Remington.

THE TEN COMMANDMENTS OF FIREARM SAFETY

The Ten Commandments of Firearm Safety should be etched in your memory forever. Let them govern your action wherever and whenever you're involved with firearms. In the field. On the range. Or in your home. Please take the time to review and understand these rules.

1st COMMANDMENT

Always Keep the Muzzle Pointed in a Safe Direction.

This is the most important firearm safety rule. A safe direction is one in which an accidental discharge will not cause injury to yourself or others. Never allow your firearm to point at anything you don't intend to shoot. Be especially careful when you're loading or unloading. Treat every firearm as if it were loaded. And make it a habit to know where the muzzle is pointed at all times, even when your firearm is un-loaded. No one will be injured by an accidental discharge if you keep your firearm pointed in a safe direction. It's as simple as that.



2nd COMMANDMENT

Firearms should be Unloaded When Not Actually in Use.

Load your firearm only when you're in the field or on the target range and ready to fire. Never let a loaded firearm out of your sight or out of your hands. Unload it as soon as you're finished shooting - before you bring it into your car, camp or home. Remember, unloading your firearm means unloading it completely, so there is no ammunition in the chamber or in the magazine. Before handling a firearm or passing it to someone else, visually check the chamber, receiver and magazine to be certain they do not contain ammunition. Always keep the firearm's action open when not in use. Never assume a firearm is unloaded even if you were the last person to use it. Always check for yourself.

- *Let common sense rule* when you carry a loaded firearm. If you're in a situation that could risk accidental discharge - such as crossing a fence, wading through a stream or climbing a tree - always unload your firearm. Never pull or push a loaded firearm toward yourself or another person. And never carry a loaded firearm in a scabbard, detached holster or gun case.

- *Certain firearms* (including some Remington® rifles and shotguns) are equipped with internal security devices to prevent unauthorized use. In addition, some firearms owners use external devices, such as cable locks and trigger blocks, for the same purpose. Even if you use such a device, you should still keep your firearm unloaded when stored or not in use. And using internal or external devices cannot substitute, however, for securing your firearms and ammunition in a separate, locked location.



Firearms should be stored in a secure place where children cannot access them. A gun safe is an ideal way to secure your firearm

- *Safe storage* of firearms is just as critical as safe handling. Never store firearms loaded. Be sure to keep your firearms in a secure place where unauthorized persons cannot get their hands on them without your knowledge.

- *Take special care* if there are children around. Children are fascinated by firearms. It's a natural curiosity that can have tragic consequences when not properly supervised. Store your firearms in a locked firearm safe or some other location that physically bars a child from gaining access.

- *Ammunition* should be stored and locked in a location separate from your firearm. Never leave an unsecured firearm or ammunition in a closet, dresser drawer or under the bed. Remember, it is your responsibility to make sure that children and others unfamiliar with firearms cannot get access to your firearm and ammunition.



3rd COMMANDMENT

DON'T RELY ON YOUR GUN'S SAFETY

Treat every firearm as if it can fire at any time, whether or not there's pressure on the trigger. Your firearm has been carefully designed to maximize performance and safety. However, because a firearm's safety is a mechanical device, it could fail.

Human error is a more likely reason for a firearm safety to fail. By mistake, you may think the safety is on when it really isn't. Or the safety may have been disengaged without your knowledge. Or you could think your firearm is unloaded when there's actually a cartridge or shell in it. A mechanical safety is not a substitute for common sense. It's merely a supplement to your proper handling of a firearm.

Never touch the trigger on a firearm until you are ready to shoot. Keep your fingers away from the trigger when you're loading or unloading. And don't pull the trigger when the safety is engaged or positioned between safe and fire.

Before using your firearm, read this instruction book to understand the exact location and operation of your firearm's safety. Even when the safety is on, maintain control of your loaded firearm and control the direction of the muzzle. In other words, don't rely on your safety to justify careless handling. If your firearm's internal mechanisms are broken or have been altered, your firearm may fire even when the safety is on. Remember, you and your safe firearm handling practices are your firearm's best safety.



4th COMMANDMENT

BE SURE OF YOUR TARGET AND WHAT'S BEYOND IT.



You can't stop a shot in mid-air, so never fire unless you know exactly where your shot is going and what it will strike. Never fire at a sound, a movement or a patch of color. Before you pull the trigger be absolutely sure of your target and what's behind it.

Make sure the shot has a backstop such as a hillside or dense material like sand. Remember, bullets can travel great distances with tremendous velocity. Know how far your shot will go if you miss your target or the bullet ricochets.



5th C O M M A N D M E N T

Use Proper Ammunition

Every firearm is designed to use a certain caliber or gauge of ammunition. Using the wrong ammunition, mixing ammunition or using improperly reloaded ammunition can cause serious personal injury or death. And it only takes one cartridge or shotshell of the incorrect caliber or gauge, or which has been improperly reloaded, to destroy your firearm. It's your responsibility to make sure the ammunition you use exactly matches the caliber or gauge of your firearm. Refer to this instruction book to find out the specific requirements of your firearm. Always read and heed the instructions on ammunition boxes.

Confusing shells or cartridges can cause serious personal injury or death and destroy your firearm. Examine your shells or cartridges closely and use only the precise caliber or gauge for your specific firearm. For example, suppose you accidentally loaded a 20 ga. shell into a 12 ga. shotgun. Because the 20 ga. shell is too small for the chamber, the 20 ga. shell could travel down the barrel and get lodged in the bore. If you then loaded a standard 12 ga. shell behind it and fired, the 12 ga. shot will slam into the lodged 20 ga. shell and may cause the barrel to explode right in your hand. This is commonly called a 12/20 burst, and it can kill you.

Check all ammunition before you load it to make sure it matches your firearm's requirements. Every Remington® cartridge and shell is head-stamped with its caliber or gauge for easy identification. Likewise, you'll find the caliber or gauge of your new Remington firearm imprinted on the barrel.

Reloading Requires Extra Diligence.

If you're an ammunition reloader, you are responsible for personally assuring that the loads and components of your reloaded ammunition meet your firearm's factory-tested standards. Never use ammunition, which has been reloaded by someone else!

Many shooters handload as a hobby or to save money on commercial, factory-made ammunition. However, it requires a thorough knowledge of reloading procedures and a deep respect for the explosive potential of gunpowder.

Firearms are designed, manufactured and proof-tested to standards based on factory-loaded ammunition. Handloaded or reloaded ammunition that deviates, either intentionally or accidentally, from load or component recommendations can be very dangerous.

Reloaders must observe all possible safety precautions and practices related to the proper handling of explosives. Whether you're a seasoned reloader or just starting out, you should study the subject, watch reloading demonstrations and talk to experienced reloaders.

The first rule of reloading is to always follow the manufacturer's instructions for the components you're using. They'll tell you to follow certain guidelines. Namely:

1. Don't mix or substitute powders or primers.
2. Don't use unknown or substandard components.
3. Use only suitable components that have been factory-tested by reputable ammunition, powder and bullet manufacturers.
4. Always be sure to use the manufacturer's recommended recipe when reloading.

Not following these guidelines could result in severe injury to yourself or severe damage to your firearm. Dangerously high pressure and explosions can result from an overcharge of powder or other deviations from established reloading guidelines. Be very careful. The process of reloading exposes you to environmentally hazardous material. Lead, which is known to cause cancer and birth defects, is the most common substance in bullets and shot. It is important to handle lead bullets and shot with extreme care. Work only in a well-ventilated area and always wash your hands after exposure and before eating. Never smoke while reloading.

Primers and powders are also highly toxic and flammable. So after reloading be sure to clean up all materials from your work area. Don't leave primer or powder spills anywhere on the floor or bench top. Dispose of all waste material in accordance with the manufacturer's recommendations.

Finally, when reloading or handloading concentrate on what you're doing at all times. Do not be distracted by talking to others, listening to the radio or watching TV while reloading. Never reload after consuming alcoholic beverages or drugs of any kind. You are working with extremely hazardous materials and you can't risk even a few seconds of distraction. Remember, if you reload, you are the ammunition manufacturer and you are responsible for the performance and safety of your reloaded ammunition.

6th C O M M A N D M E N T

IF YOUR FIREARM FAILS TO FIRE WHEN THE TRIGGER IS PULLED, HANDLE WITH CARE.

If for some reason the ammunition doesn't fire when you pull the trigger, stop and remember the 1st Commandment of Firearm Safety - always keep the muzzle pointed in a safe direction. Keep your face away from the breech, then put the safety on, carefully open the action, unload the firearm and dispose of the cartridge safely. Remember that anytime there's a shell in the chamber, your firearm is loaded and ready to use. Even if you tried to shoot and your firearm didn't fire, treat your firearm as if it could still discharge.

7th C O M M A N D M E N T

ALWAYS WEAR EYE AND EAR PROTECTION WHEN SHOOTING.

Your sight and hearing risk injury from shooting and should be protected at all times. Wear protective shooting glasses to guard against falling shot, clay target chips, powder residue, ruptured cartridge cases and even twigs and branches in the field. Also be sure to wear eye protection when you're disassembling or cleaning a firearm so that tensioned parts (like springs) and cleaning solvents don't come in contact with your eyes. Continued exposure to shooting noise can permanently damage your hearing. On the range, where shooting volume is the loudest, be sure to use the maximum protection of a headset. Learn to use ear protection at all times.



8th C O M M A N D M E N T

BE SURE THE BARREL IS CLEAR OF OBSTRUCTIONS BEFORE SHOOTING.

Before loading your firearm, open the action and make sure there's no ammunition in the chamber or magazine. Check the barrel for any obstructions or debris. Even a small amount of snow, mud, excess lubricant or grease in the bore can dangerously increase pressure and cause the barrel to bulge or burst when firing. Use a cleaning rod and patch to wipe away anti-rust compounds or any other residues or obstructions in the barrel. Never try to shoot out an obstruction by loading another shell and firing!

When firing, rely on your instincts. If the noise or recoil of your firearm seems weak, stop everything, unload your firearm and be sure nothing is lodged in the barrel. Remember the 12/20 burst? That's what can happen when the barrel is obstructed. Always be sure you're using the correct ammunition in your firearm and that it's free of obstructions.

9th C O M M A N D M E N T

DON'T ALTER OR MODIFY YOUR FIREARM. HAVE IT SERVICED REGULARLY.

Your firearm has been designed to operate according to certain factory specifications. You'll jeopardize your safety and that of others around you by attempting to alter its trigger, mechanical safety or other mechanisms. So never alter or modify your firearm in any way.



Like any mechanical device, a firearm is subject to wear. It must be maintained and periodically serviced to assure optimum safety and performance. Only a qualified service facility should service, repair or modify your Remington® firearm. Consult your instruction book for instructions on how to send your firearm to the factory or for the location of the nearest Remington Authorized repair station.

Proper cleaning and lubrication are also important to firearm maintenance and are necessary to assure accuracy, safety and reliability. Before cleaning, always make sure that your firearm is completely unloaded. And always clean

the barrel from the chamber end to the muzzle when possible.

Make it a practice to clean your bore every time you're going to shoot. Be sure to clean your entire firearm before and after long-term storage and no less than once a year. It's also important to clean your firearm whenever it's been exposed to adverse conditions such as rain, dirt, mud, snow, sleet or saltwater.

For safe and dependable operation of your firearm, all parts of your firearm must be properly cleaned and lubricated. Periodically inspect the internal workings of your firearm to be sure they're clean and free of rust, unwanted dirt and debris.

Use recommended lubricants on your firearm and do not over-lubricate. The use of a non-recommended lubricant could adversely affect the function and safe operation of your firearm. Remember, you are responsible for the proper care and maintenance of your firearm. Failure to properly maintain your firearm cannot only damage or ruin your firearm, it can expose you and others to unnecessary risks of personal injury or death.

Remington® has a wide range of firearm care products and resources for best results when cleaning your firearm. Everything from solvents and lubricants to rods and patches. They're all available from your Remington dealer.

10th C O M M A N D M E N T

LEARN THE MECHANICS AND HANDLING CHARACTERISTICS OF YOUR FIREARM.

Not all firearms are alike. They have different mechanical characteristics that dictate how you should carry and handle them. Anyone who plans to use a firearm should first become totally familiar with the type of firearm it is and the safe handling procedures for loading, unloading, carrying, shooting and storing it.

Before you even unpack your new Remington firearm, read this instruction book from cover to cover and familiarize yourself with the different component parts of the firearm. Then read, understand and follow the Ten Commandments of Firearm Safety in this book.

WARNING! Discharging firearms in poorly ventilated areas, cleaning firearms or handling ammunition may result in exposure to lead, a substance known to cause birth defects, reproductive harm, cancer and other serious physical injury. Have adequate ventilation at all times. Wash hands thoroughly after exposure.



SHOOT SOBER!!

There's one other rule that must be followed when handling firearms. In fact, respect for this rule is necessary in order to effectively practice the Ten Commandments of Firearm Safety. The rule is: SHOOT SOBER! Firearms and alcohol or drugs make a deadly combination. Never consume anything that would mildly impair your judgment or physical coordination when you're using a firearm. A staggering percentage of the shooting accidents that occur every year involve alcohol or drugs. Be smart. Always shoot sober and stay alive.

WARNING! Failure to follow any of these safety rules may cause personal injury or death to the shooter or bystander and damage to property. Do not use a firearm until you fully understand and practice the Ten Commandments of Firearm Safety. If you have any questions about the safe use of a Remington firearm, write to us at Remington Arms Company, LLC, Consumer Service, P.O. Box 700, Madison, NC 27025-0700, or call us at 1-800-243-9700.

DON'T KEEP THIS TO YOURSELF.

Now that you're a firearm owner you have the obligation to help ensure that shooting sports are safe for everyone - participants and bystanders alike. You can do that by practicing these principles of firearm safety and passing them on to others - especially new shooters. Set an example for beginners. Be a guide to their safe entry into the exciting world of shooting sports. Invest your time and patience for the love of the sport and for its future. After all, it's your love of the sport that led you to buy a new Remington.

Firearm ownership is a right and privilege. It's a right guaranteed in this nation's Constitution. It's a privilege, which carries with it a personal responsibility to use your firearm in a way which will ensure your safety and the safety of others. The preservation of this right and privilege depends on the personal commitment of you and your fellow shooters to the safe and responsible use of firearms. Let the Ten Commandments of Firearm Safety outlined in the book guide you at all times. Teach and promote these rules whenever you can. Remember, firearm safety depends on you! That's the only way to really enjoy your new Remington firearm and to preserve sport shooting as we know it today.

Remington® Model 572™ Pump Action Rimfire Rifle and Model 552™ Autoloading Rimfire Rifle

Congratulations on your choice of a Remington.® With proper care, it should give you many years of dependable use and enjoyment. For best results, we recommend that you use Remington Ammunition – the ammunition used in factory testing your firearm against our exacting function and performance standards.

PICTURE 1 A These pictures show the main parts of the REMINGTON MODEL 572™ PUMP ACTION RIMFIRE RIFLE AND THE MODEL 552™ AUTOLOADING RIMFIRE RIFLE. The picture will aid in understanding the instructions in this book.

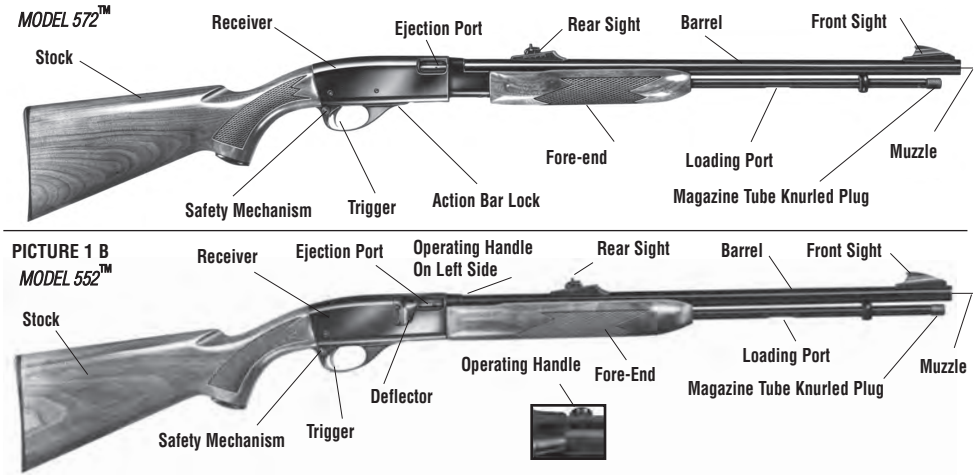

PICTURE 2 This picture shows the main parts of the ammunition. 22 CALIBER CARTRIDGE



Important Parts of the Firearm

The Safety Mechanism

The safety mechanism on the Model 572™ and Model 552™ Rimfire Rifle is a button located behind the trigger. See Pictures 3 and 4.

The safety mechanism provides protection against accidental or unintentional discharge under normal usage when properly engaged and in good working order.

To engage the safety mechanism, push the button so that the **RED BAND MARKING CANNOT BE SEEN.**

Always engage the safety mechanism when the firearm is loaded and you do not intend to shoot.

Never pull the trigger when the safety mechanism is engaged.

When you are ready to fire the firearm, press the safety mechanism so that the **RED BAND MARKING IS SHOWING.** Do not touch the trigger while moving the safety mechanism. Your fingers and all other objects should be kept outside the trigger guard and away from the trigger until you are actually ready to fire by pulling the trigger.

WARNING: The firearm will fire when the trigger is pulled and the **RED BAND IS SHOWING.**

Even when the safety mechanism is engaged, careless handling can cause the firearm to fire. See the *Ten Commandments of Firearm Safety* on page 2.

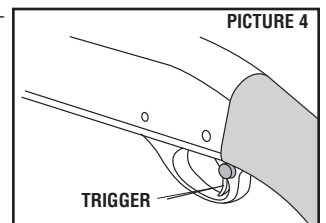
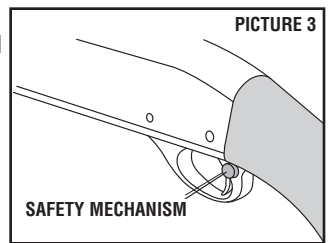

The Security System

The firearm you have purchased is equipped with either an integrated security system or with a separate locking device.

The separate locking device included with your firearm will be packaged with its own instructions.

The integrated security system locking device instructions are described below.

The security system enables the owner to lock the safety mechanism on the firearm in the "SAFE" position with the use of a special key.

THIS SECURITY SYSTEM DOES NOT ELIMINATE THE NEED FOR SAFE GUN HANDLING AND STORAGE, INCLUDING KEEPING THIS AND EVERY GUN UNLOADED AND LOCKED IN A SECURE PLACE WHEN NOT IN USE. READ AND FOLLOW THESE AND OTHER SAFETY RULES IN THIS INSTRUCTION BOOK. FAILURE TO READ, UNDERSTAND AND OBEY THESE RULES CAN RESULT IN SERIOUS PERSONAL INJURY OR DEATH TO YOU OR OTHERS. SEE THE TEN COMMANDMENTS OF FIREARM SAFETY ON PAGE 2.

Integrated Security System:

On the safety mechanism there is a "J" shaped slot. See Picture 5. This "J" slot is the key hole for securing your safety mechanism. Also on the safety mechanism is a pointer which will point and line up with either the **RED** or **WHITE DOT** on the trigger plate when the safety mechanism is turned. See Picture 5. The position of the pointer indicates whether or not the security system is engaged. The existence of the security system does not change the basic operation of the safety mechanism, nor does it change the manner in which the safety mechanism should be used.

With your new firearm you will receive a capped key. To use the key remove the cap. On the key is an indicator line which will line up with the pointer on the safety mechanism. See Picture 5.

To engage the security system, press the safety mechanism to the "SAFE" position so the **RED BAND DOES NOT SHOW**. Insert the key into the "J" slot as far as it can go. Next, turn the key counter-clockwise so that the indicator line on the key and the pointer on the safety mechanism line up with the **WHITE DOT** on the trigger plate.

THE SECURITY SYSTEM IS NOW ENGAGED.

In operating the security system, **NEVER** use excessive force to turn the key. If the key will not turn freely, contact a Remington® Authorized Service Center.

Keep your security system engaged and your safety mechanism in the "SAFE" position when your firearm is not in use. Keep your key in a secure place, inaccessible to others. **DO NOT** leave your key or any ammunition with your firearm, which should be kept unloaded and locked in a safe place.

If you lose the key, **DO NOT** attempt to disengage the safety mechanism using a foreign object. This will damage your firearm. Contact your Remington Authorized Service Center for a replacement key.

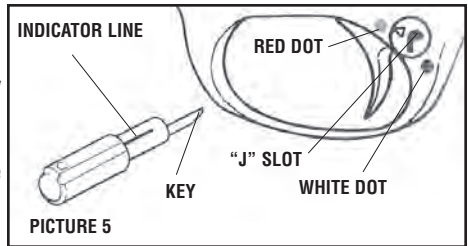

Even if you think the security system and safety mechanism are engaged, careless handling can cause the firearm to fire. See the *Ten Commandments of Firearm Safety* on page 2.

The Operating Handle (Model 552)

The operating handle is on the left-hand side of the Model 552 and is used to pull the bolt rearward to open the action. See Picture 6.

WARNING: When the operating handle is forward as shown in Picture 6, the bolt is closed and is in the ready-to-fire position.

The Fore-End

The fore-end on the Model 572 is used to pull the bolt rearward. To open the action, push up on the action bar lock and pull the fore-end rearward. See Picture 7.

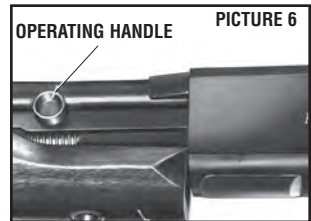

WARNING: When the fore-end is fully forward as shown in Picture 7, the bolt is closed and is in the ready-to-fire position.

TO REMOVE THE INNER MAGAZINE TUBE:

WARNING: Check the chamber and magazine to make sure there are no cartridges in the firearm.

1. Point the firearm in a safe direction.
2. Engage the safety mechanism. **RED BAND WILL NOT SHOW.**
3. Unlock the inner magazine tube by turning the knurled plug at the end of the tube. See Picture 8.
4. Pull the inner magazine tube from magazine tube.

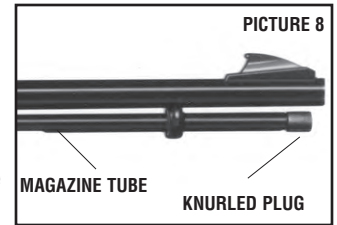
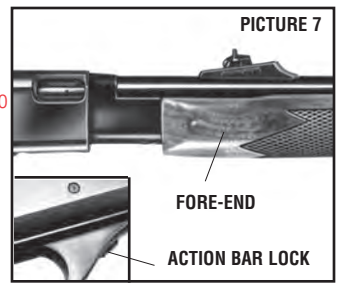

The Trigger Assembly

Pulling the trigger fires the firearm.

The weight of the trigger pull is preset at the factory.

All adjustments to the trigger and trigger plate assembly must be made by the factory or a REMINGTON® AUTHORIZED SERVICE CENTER.

WARNING: NEVER put your finger on the trigger unless you are going to fire the firearm.

The Barrel

The inside of the barrel must be clean and free of obstructions.

TO CHECK THE INSIDE OF THE BARREL ON THE MODEL 552:

WARNING: Look into the ejection port. Check the chamber and magazine to make sure there are no cartridges in the firearm.

1. Point the firearm in a safe direction.
2. Engage the safety mechanism. Make sure the **RED BAND IS NOT SHOWING.**
3. Pull the operating handle fully rearward and hold fully rearward.
4. Insert a cleaning rod into the muzzle. Push the rod completely through the barrel until the rod can be seen in the ejection port.

TO CHECK THE INSIDE OF THE BARREL ON THE MODEL 572:

WARNING: Look into the ejection port. Check the chamber and magazine to make sure there are no cartridges in the firearm.

1. Point the firearm in a safe direction.
2. Engage the safety mechanism. Make sure the **RED BAND IS NOT SHOWING.**
3. Pull the fore-end fully rearward.
4. Insert a cleaning rod into the muzzle. Push the rod completely through the barrel until the rod can be seen in the ejection port.

TO REMOVE OBJECT FROM INSIDE THE BARREL:

WARNING: Never try to remove an object from the barrel by loading another cartridge and firing. This may cause the barrel to burst or a cartridge case to rupture and cause serious personal injury.

1. Use the correct size cleaning rod.
2. Insert the cleaning rod into the muzzle and lightly tap rod to free object.
3. Push the cleaning rod all the way through the barrel, until the rod can be seen in the ejection port.
4. If an object cannot be easily pushed out of the barrel with a cleaning rod, return the firearm to the factory or a REMINGTON AUTHORIZED SERVICE CENTER.

TO CLEAN THE BARREL FOLLOW THE INSTRUCTIONS SHOWN ON PAGE 12.

BEFORE LOADING THE FIREARM: Make sure the inside of the barrel is free of dirt or other objects.

To Load The Model 552

WARNING: Always check the cartridges for the correct caliber before loading the firearm.

I. TO LOAD ONE CARTRIDGE ONLY:

NOTE: The chamber should be cleaned before loading and firing the firearm the first time. Follow cleaning instructions shown on page 12.

1. Check the chamber and magazine to make sure there are no cartridges in the firearm.
2. Point the firearm in a safe direction throughout the loading process.
3. Engage the safety mechanism. **RED BAND WILL NOT SHOW.**
4. Pull the operating handle fully rearward and hold.
5. Put one cartridge of the correct caliber through the ejection port and into the chamber. See Picture 9.
6. Keep your fingers away from the ejection port.
7. Release the operating handle to close the action.

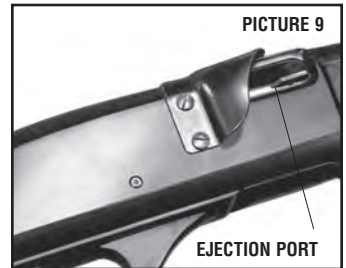

THE FIREARM IS NOW LOADED WITH A ROUND IN THE CHAMBER.

8. To prepare to fire, disengage the safety mechanism. **RED BAND WILL SHOW.**

THE FIREARM IS NOW READY TO FIRE.

9. Pull the trigger to fire the firearm.
10. Engage the safety mechanism when you are finished firing. **RED BAND WILL NOT SHOW.**

II. TO LOAD THE CHAMBER AND MAGAZINE:

1. Check the chamber and magazine to make sure there are no cartridges in the firearm.
2. Point the firearm in a safe direction throughout the loading process.
3. Engage the safety mechanism. **RED BAND WILL NOT SHOW.**
4. Unlock the inner magazine tube by turning the knurled plug at the end of the tube.
5. Pull the inner magazine forward from the magazine tube until the loading port is open. See Picture 10.
6. Insert cartridges through the loading port, bullet end forward towards the muzzle.
7. Load magazine to capacity, tubular magazine will hold 20 shorts, 17 long or 15 long rifle cartridges.
8. Close the loading port in the magazine by sliding the inner magazine tube back into the magazine.

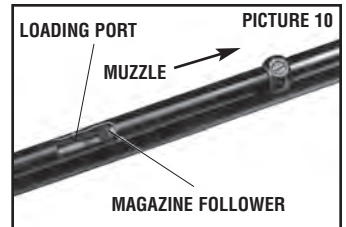

NOTE: Turn the tube slightly to ease passage over loaded cartridges.

9. Turn the tube clockwise to lock the inner magazine to the magazine tube.

IMPORTANT: Inner magazine tube will not lock properly if too many cartridges are loaded into the magazine.

10. Pull the operating handle fully rearward and release. This will load a cartridge from the magazine into the chamber.

THE CHAMBER AND MAGAZINE ARE NOW FULLY LOADED.

11. To prepare to fire, disengage the safety mechanism. **RED BAND WILL SHOW.**

THE FIREARM IS NOW LOADED AND READY TO FIRE.

12. The firearm will fire each time the trigger is pulled until the magazine and chamber are empty.
13. Engage the safety mechanism when you are finished firing. **RED BAND WILL NOT SHOW.**

To Load The Model 572

I. TO LOAD ONE CARTRIDGE ONLY:

WARNING: Always check the cartridge for the correct caliber before loading the firearm.

NOTE: The chamber should be cleaned before loading and firing the firearm the first time. Follow cleaning instructions shown on page 12.

1. Check the chamber and magazine to make sure there are no cartridges in the firearm.
2. Point the firearm in a safe direction throughout the loading process.
3. Engage the safety mechanism. **RED BAND WILL NOT SHOW.**
4. Pull the fore-end fully rearward to open the action.
5. Put one cartridge of the correct caliber through the ejection port and into the chamber. See Picture 11.
6. Keep your fingers away from the ejection port.
7. Push the fore-end forward close the action.

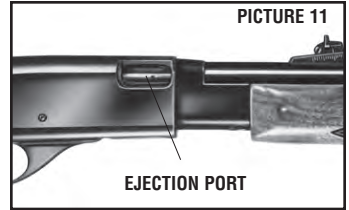

THE FIREARM IS NOW LOADED WITH A ROUND IN THE CHAMBER.

8. To prepare to fire, disengage the safety mechanism. **RED BAND WILL SHOW.**

THE FIREARM IS NOW READY TO FIRE

9. Pull the trigger to fire the firearm.
10. Engage the safety mechanism when you are finished firing. **RED BAND WILL NOT SHOW.**

II. TO LOAD THE CHAMBER AND MAGAZINE:

WARNING: Always check the cartridge for the correct caliber before loading the firearm.

1. Check the chamber and magazine to make sure there are no cartridges in the firearm.
2. Point the firearm in a safe direction throughout the loading process.
3. Engage the safety mechanism. **RED BAND WILL NOT SHOW.**
4. Unlock the inner magazine tube by turning the knurled plug at the end of the tube.
5. Pull the inner magazine forward from the magazine tube until the loading port is open. See Picture 10.
6. Insert cartridges through the loading port, bullet end forward towards the muzzle.
7. Load magazine to capacity, tubular magazine will hold 20 shorts, 17 long or 15 long rifle cartridges.
8. Close the loading port in the magazine by sliding the inner magazine tube back into the magazine.

NOTE: Turn the tube slightly to ease passage over loaded cartridges.

9. Turn the tube clockwise to lock the inner magazine to the magazine tube.

IMPORTANT: Inner magazine tube will not lock properly if too many cartridges are loaded into the magazine.

10. Pull the fore-end fully rearward and then push the fore-end fully forward. This will close the action and load a cartridge from the magazine into the chamber.

THE CHAMBER AND MAGAZINE ARE NOW FULLY LOADED.

11. To prepare to fire, disengage the safety mechanism. **RED BAND WILL SHOW.**

THE FIREARM IS NOW READY TO FIRE.

12. Pull the trigger to fire the firearm.
 13. Pull the fore-end fully rearward to eject the empty cartridge. forward to chamber the next cartridge. 15.
- Engage the safety mechanism when you are finished firing. **RED BAND WILL NOT SHOW.**

To Unload the Firearm (Model 552 and Model 572)

1. Point the firearm in a safe direction throughout the unloading process.
2. Engage the safety mechanism. **RED BAND WILL NOT SHOW.**
3. Turn the knurled plug to unlock the inner magazine tube from the magazine tube.
4. Pull the inner magazine tube completely from the magazine tube.
5. Tilt the muzzle down to allow the cartridges to slide from the mag-

14. Slide the fore-end

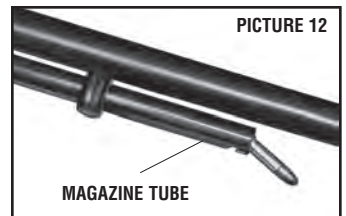

azine.

Shake the firearm slightly to make sure all cartridges slide from the magazine. See Picture 12.

6. Replace and lock the inner magazine tube.

WARNING: Two cartridges may remain in the rifle after the magazine is unloaded - one in the chamber and one in the action. To unload those cartridges:

7a. **Model 552**

Pull the operating handle fully rearward to extract and eject the round from the chamber and repeat as many times as necessary to unload any rounds from the action.

7b. **Model 572**

Pull the fore-end fully rearward and repeat as many times as necessary to extract and eject the round from the chamber and any rounds from the action.

WARNING: Visually check the chamber, action and magazine to make sure there are no cartridges in the firearm.

NOTE: The end of the magazine follower can be seen when the action is open and the last cartridge is removed from the action. See Picture 13 and 14.

To Adjust the Sights

WARNING: NEVER adjust the sights on a loaded firearm. Make sure the chamber and magazine are completely unloaded before adjusting the sights. Also make sure the safety mechanism is engaged. RED BAND WILL NOT SHOW.

TO ADJUST THE REAR SIGHT:

For elevation (up and down adjustments) and windage (left and right adjustments), move the rear sight in the same direction as you need to move the bullet on the target. See Picture 15.

NOTE: For more information on ballistics and trajectory, see the REMINGTON® catalog.

TELESCOPIC SIGHTS:

The receiver is designed with two long dovetail grooves cut into the top panel. A receiver type mount may be used. Slide the mount into the grooves and tighten in the desired location.

TO CLEAN THE BARREL:

WARNING: NEVER attempt to clean the barrel on a loaded firearm. Check the chamber and magazine to make sure there are no cartridges in the firearm.

1. Use the instructions and the equipment provided in a good cleaning kit. For recommendations, see your Remington Authorized Service Center.
2. Select the correct caliber cleaning brush and attach the brush to the cleaning rod.
3. Put the cleaning brush into the gun cleaning solvent.
4. Push the cleaning brush through the barrel several times.

NOTE: Always clean the barrel from the muzzle to the chamber.

5. Remove the brush from the rod. Attach tip with correct size cleaning patch and push through the bore.
6. Repeat several times using a new cleaning patch each

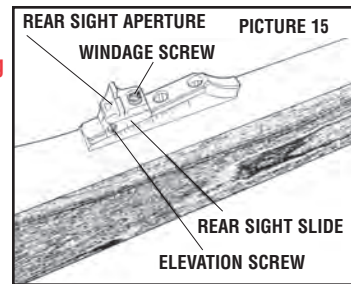
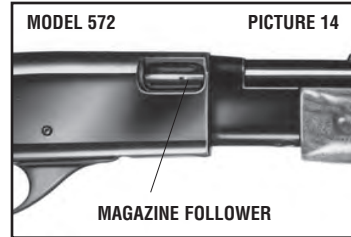
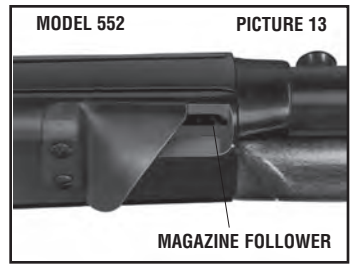

POSITION ON TARGET	ADJUSTMENTS
<p>Bullets hits above the center.</p>	<ol style="list-style-type: none"> Loosen the elevation screw on the rear sight. Slide the rear sight down (backward) on the ramp. Tighten the elevation screw.
<p>Bullets hits below the center.</p>	<ol style="list-style-type: none"> Loosen the elevation screw on the rear sight. Slide the rear sight up (forward) on the ramp. Tighten the elevation screw.
<p>Bullets hits to the left.</p>	<ol style="list-style-type: none"> Loosen the windage screw on the rear sight. Slide the rear sight aperture to the right. Tighten the windage screw.
<p>Bullets hits to the right.</p>	<ol style="list-style-type: none"> Loosen the windage screw on the rear sight. Slide the rear sight aperture to the left. Tighten the elevation screw.

time, until the patch is not dirty.

7. Push a clean patch saturated with Rem™ Oil through the barrel.
8. Push a clean, dry patch through the barrel to remove excess lubricant.
9. Apply a thin coat of Rem™ Oil to the outside of the barrel with a soft, clean cloth.

WARNING: After cleaning, make sure the barrel is free of obstructions.

How To Disassemble

To Disassemble The Model 552:

WARNING: NEVER attempt to disassemble a loaded firearm.

Check the chamber and magazine to make sure there are no cartridges in the firearm.

1. Point the firearm in a safe direction.
2. Engage the safety mechanism. **RED BAND WILL NOT SHOW.**
3. Tap out the front and rear trigger plate pins. See Picture 16.
4. Lift and remove the trigger plate assembly from the receiver.
5. Unscrew the take-down screw. See Picture 17.
6. Separate the fore-end slightly from the receiver.
7. Grasp the fore-end firmly to the barrel and pull the barrel and bolt assembly from the receiver. See Picture 17.
8. Slide the action bar from the bolt slot. See Picture 18.
9. Pull the bolt assembly from the barrel.

To Disassemble The Model 572:

WARNING: NEVER attempt to disassemble a loaded firearm.

Check the chamber and magazine to make sure there are no cartridges in the firearm.

1. Point the firearm in a safe direction.
2. Engage the safety mechanism. **RED BAND WILL NOT SHOW.**
3. Tap out the front and rear trigger plate pins. See Picture 16.
4. Lift and remove the trigger plate assembly from the receiver.
5. Unscrew and remove the barrel dowel screw and washer. See Picture 19.
6. Unscrew and remove the barrel lock screw.
7. Separate the fore-end slightly from the receiver.
8. Grasp the fore-end firmly to the barrel and pull the barrel and bolt assembly from the receiver. See Picture 20.
9. Lift the action bar lug from the bolt. See Picture 21.
10. Pull the bolt assembly from the barrel.

CLEANING AND LUBRICATION:

WARNING: NEVER attempt to clean or lubricate a loaded firearm.

Check the chamber and magazine to make sure there are no cartridges in the firearm.

Action Bar

1. Brush with gun cleaning solvent and wipe dry with a clean cloth.
2. Apply a thin coat of Rem™ Oil to prevent rusting.

Bolt Assembly

1. Brush with gun cleaning solvent and wipe dry with a clean cloth.
2. Apply a thin coat of Rem™ Oil to prevent rusting.

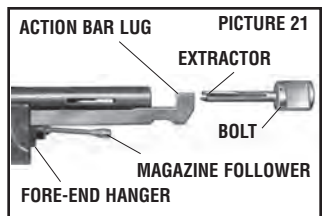
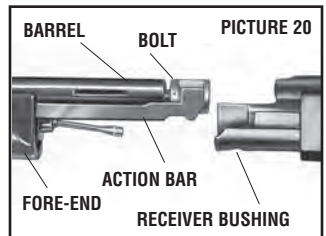
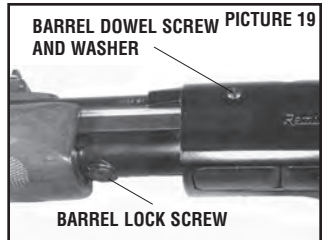
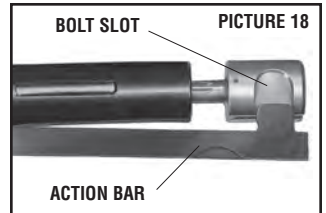
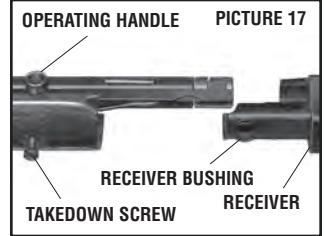
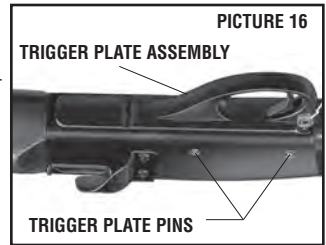

Receiver Assembly

1. Brush the inside of the receiver with gun cleaning solvent and wipe dry with a clean cloth.
2. Apply a thin coat of Rem™ Oil to prevent rusting.

Trigger Plate Assembly

NOTE: Clean the trigger plate assembly as a unit.

1. Spray the trigger plate assembly with Rem™ Oil as shown. See Picture 22.
2. Let stand for 15 minutes.
3. Spray again to wash off components.
4. Shake off excess lubrication.

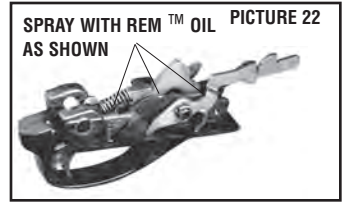

WARNING: Excessive use of a non-recommended lubricant could adversely affect the function and safe operation of your firearm.

To Reassemble

To Reassemble The Model 552:

Bolt to Barrel

1. Align the extractors in the bolt to re-enter the extractor slots in the barrel.
2. Slide the bolt into the barrel.

NOTE: The bolt must be replaced into the barrel with the action bar lug slot facing the action bar.

3. Position the action bar lug in the matching slot in the bolt.
4. With the action bar engaging the the bolt, hold the fore-end and barrel firmly together.
5. Slide the barrel, assembled bolt, and action bar into the receiver.
6. Seat the fore-end hanger (within the fore-end) firmly into the receiver.

NOTE: If the inner magazine tube is in the rifle, make sure the flexible magazine follower re-enters the receiver freely.

7. Align the fore-end hanger screw hole with the take-down screw hole in the receiver.
8. Replace and tighten the take-down screw.
9. Replace the trigger plate assembly. Make sure the hammer is in the cocked position. See Picture 21.
10. Carefully guide projecting carrier and disconnecter into the receiver. See Picture 23.

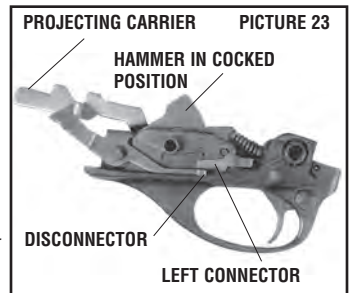

NOTE: Check to make sure that the end of the disconnecter is below the end of the left connector. See Picture 23.

11. Tap in the front and rear trigger plate pins.

To Reassemble The Model 572:

Bolt to Barrel

1. Align the extractors in the bolt to re-enter the extractor slots in the barrel.
2. Slide the bolt into the barrel.

NOTE: The bolt must be replaced into the barrel with the action bar lug slot facing the action bar.

3. Position the action bar lug in the matching slot in the bolt.
4. With the action bar engaging the the bolt, hold the fore-end and barrel firmly together.
5. Slide the barrel, assembled bolt, and action bar into the receiver.
6. Seat the fore-end hanger (within the fore-end) firmly into the receiver.

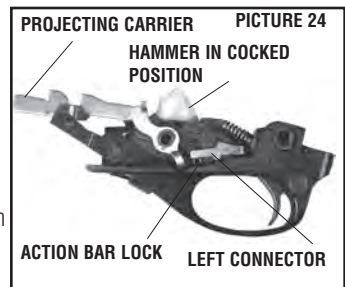

NOTE: If the inner magazine tube is in the rifle, make sure the flexible magazine follower re-enters the receiver freely.

7. Align the fore-end hanger screw hole with the barrel lock screw hole in the receiver.
8. Replace and tighten the take-down screw.
9. Replace and tighten barrel dowel screw and washer.
10. Replace the trigger plate assembly. Make sure the hammer is in the cocked position. See Picture 24.
11. Carefully guide projecting carrier and action bar lock into the receiver. See Picture 22.

NOTE: Check to make sure that the end of the action bar lock is below the end of the left connector. See Picture 24.

12. Tap in the front and rear trigger plate pins.

Lubrication

Over-lubrication should be avoided at all times. A light application of Rem™ Oil helps to prevent rusting.

WARNING! Excessive use of a lubricant could adversely affect the function and safe operation of your firearm. Failure to properly maintain your firearm can not only damage your firearm, it can expose you and others to unnecessary risks of personal injury or death.



When the firearm is to be stored, it should be carefully cleaned and thoroughly oiled. Outside metal surfaces should be wiped with Rem™ Oil occasionally. When the firearm is to be reused, all excess lubrication must be removed. The chamber and bore must be thoroughly wiped dry.

For safe and dependable operation of your firearm, the barrel and action must be cleaned periodically.

Remington recommends using Remington cleaning products and lubricants or their equivalents.

WARNING! The use of a non recommended lubricant or cleaner could adversely affect the function and safe operation of your firearm. Do not use congealing lubricants. The use of non-congealing lubricants such as Rem™ Oil is strongly recommended.

NOTE: Remington's Rem™ Oil is available from your local dealer. If your dealer is out of stock, ask the dealer to order Rem™ Oil from the Remington Distributor.

MODEL 552™

Autoloading Rimfire Rifle

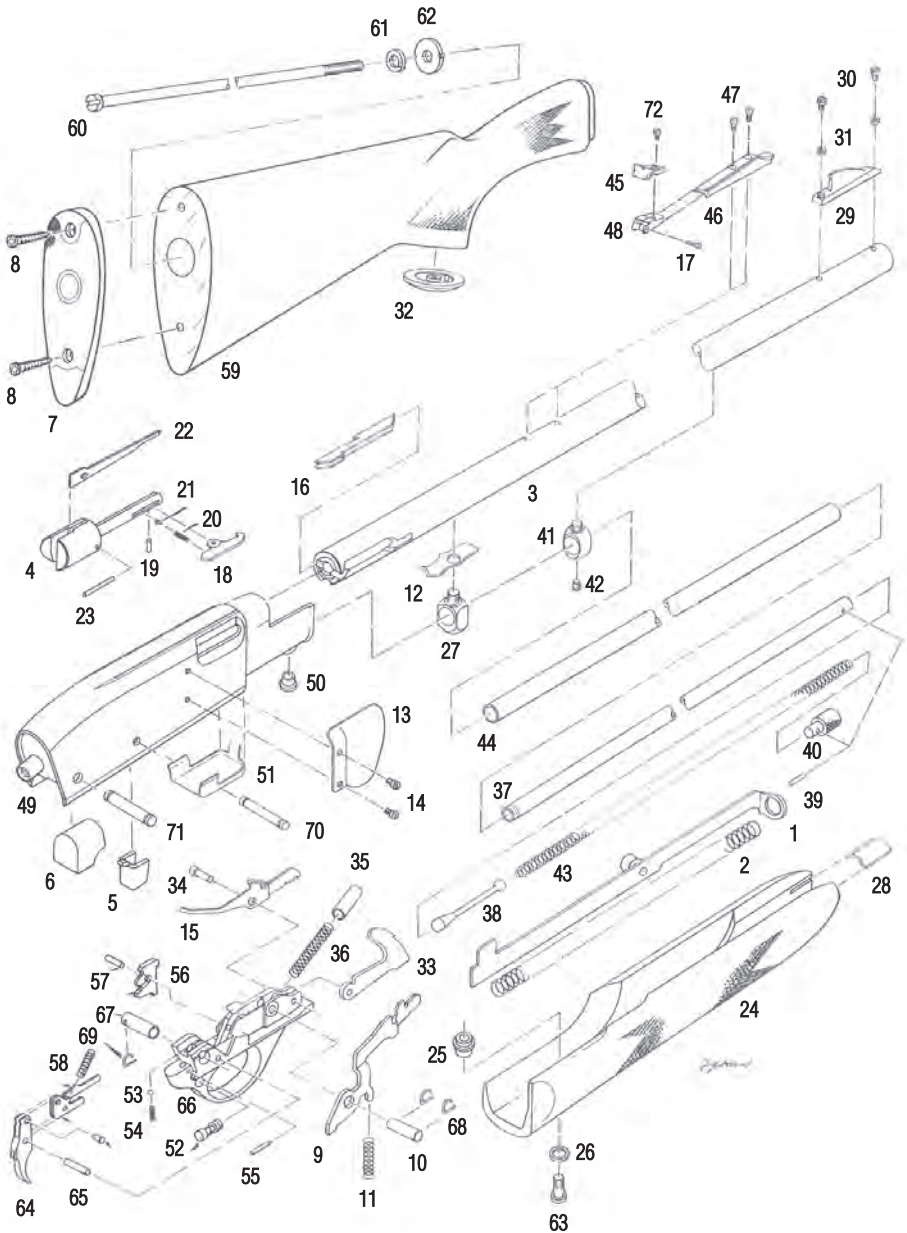

MODEL 552™

Autoloading Rimfire Rifle

PARTS LIST

VIEW# PART NAME

NOTE: See Exploded View For Proper Identification Of Parts

- 1 Action Bar Assembly
- 2 Action Spring
- 3 Barrel
- 4 Bolt (Restricted)
- 5 Bolt Buffer
- 6 Buffer Pad
- 7 Butt Plate
Butt Plate Insert (Not Shown)
- 8 Butt Plate Screw
Butt Plate Insert Screw (Not Shown)
- 9 Carrier
- 10 Carrier Pivot Tube
- 11 Carrier Spring
- 12 Cartridge Ramp
- 13 Deflector
- 14 Deflector Screw
- 15 Disconnecter
- 16 Ejector
- 17 Elevation Screw
- 18 Extractor
- 19 Extractor Pin
- 20 Extractor Spring
- 21 Extractor Spring Seat
- 22 Firing Pin
- 23 Firing Pin Retaining Pin
- 24 Fore-End Assembly
- 25 Fore-End Escutcheon
- 26 Fore-End Escutcheon Nut
- 27 Fore-End Hanger
- 28 Fore-End Support
- 29 Front Sight
- 30 Front Sight Screw
- 31 Front Sight Washer
- 32 Grip Cap
- 33 Hammer
- 34 Hammer Pin
Hammer Pin Washer (Not Shown)
- 35 Hammer Plunger
- 36 Hammer Spring
- 37 Inner Magazine Tube
- 38 Magazine Follower
- 39 Magazine Pin
- 40 Magazine Plug
- 41 Magazine Ring
- 42 Magazine Screw
- 43 Magazine Spring
- 44 Outer Magazine Tube
- 45 Rear Sight Aperture
- 46 Rear Sight Base
- 47 Rear Sight Base Screw

VIEW# PART NAME

NOTE: Parts Subject To Change Without Notice FOB Ilion, New York.

- 48 Rear Sight Base Slide
- 49 Receiver (Restricted)
- 50 Receiver Bushing
- 51 Receiver Cover
- 52 Safety Mechanism
- 53 Safety Mechanism Detent Ball
- 54 Safety Mechanism Spring
- 55 Safety Mechanism Spring Retaining Pin
- 56 Sear
- 57 Sear Pin
- 58 Sear Spring
- 59 Stock Assembly
- 60 Stock Bolt
- 61 Stock Bolt Lock Washer
- 62 Stock Bolt Washer
- 63 Take Down Screw
- 64 Trigger Assembly (Restricted)
(Includes: Connector Left, Connector Right, Connector Pin and Trigger)
- 65 Trigger Pin
- 66 Trigger Plate
- 67 Trigger Plate Pin Bushing, Rear
- 68 Trigger Plate Pin Detent Spring, Front
- 69 Trigger Plate Pin Detent Spring, Rear
- 70 Trigger Plate Pin, Front
- 71 Trigger Plate Pin, Rear
- 72 Windage Screw

MODEL 572™

Pump Action Rimfire Rifle

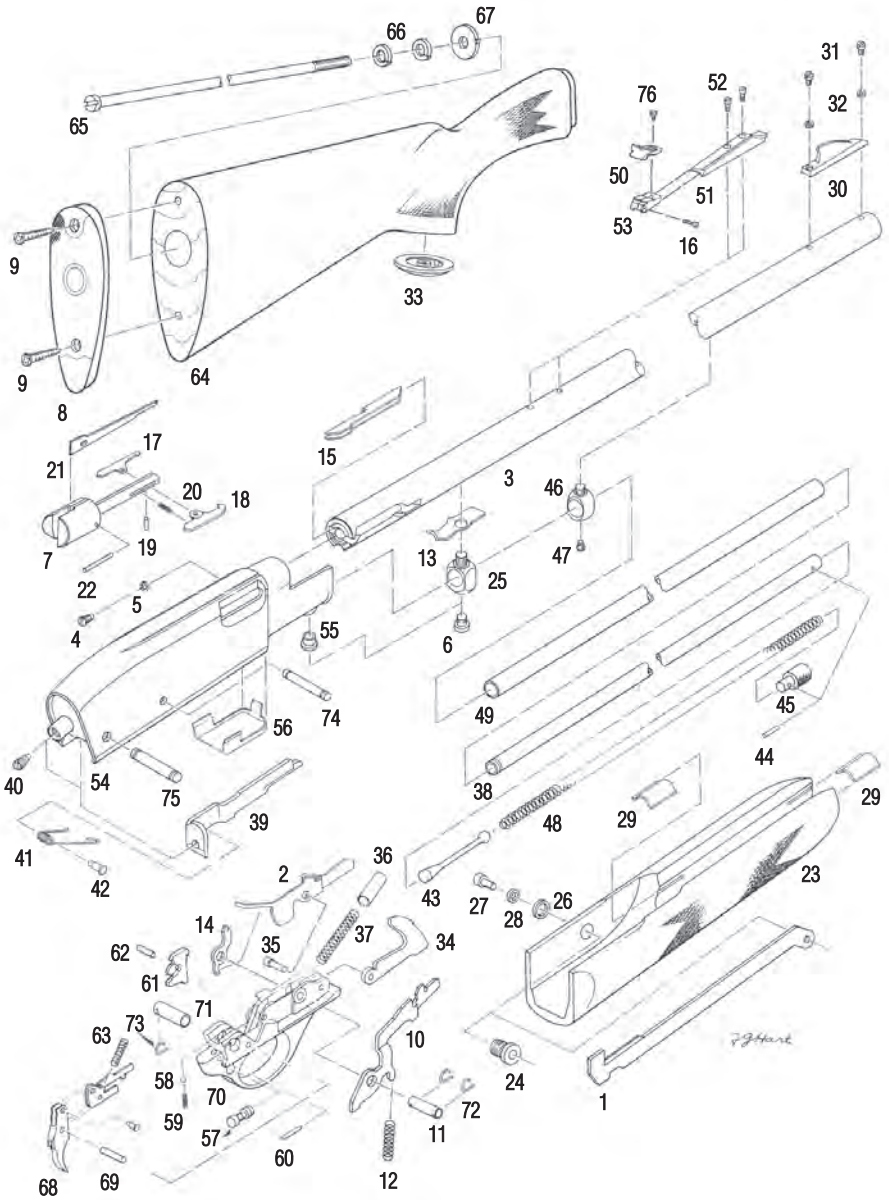

MODEL 572™

Pump Action Rimfire Rifle

PARTS LIST

VIEW# PART NAME

NOTE: See Exploded View For Proper Identification Of Parts

- 1 Action Bar
- 2 Action Bar Lock
- 3 Barrel
- 4 Barrel Dowel Screw
- 5 Barrel Dowel Screw Washer
- 6 Barrel Lock Screw
- 7 Bolt (Restricted)
- 8 Butt Plate
- 8 Butt Plate Insert (Not Shown)
- 9 Butt Plate Screw
- 9 Butt Plate Insert Screw (Not Shown)
- 10 Carrier
- 11 Carrier Pivot Tube
- 12 Carrier Spring
- 13 Cartridge Ramp
- 13 Deflector
- 14 Disconnecter
- 15 Ejector
- 16 Elevation Screw
- 17 Extractor, Left
- 18 Extractor, Right
- 19 Extractor Pin
- 20 Extractor Spring
- 21 Firing Pin
- 22 Firing Pin Retaining Pin
- 23 Fore-End Assembly
- 24 Fore-End Escutcheon
- 25 Fore-End Hanger
- 26 Fore-End Nut
- 27 Fore-End Screw
- 28 Fore-End Lock Washer
- 29 Fore-End Support (2)
- 30 Front Sight
- 31 Front Sight Screw
- 32 Front Sight Washer
- 33 Grip Cap
- 34 Hammer
- 35 Hammer Pin
- 35 Hammer Pin Washer (Not Shown)
- 36 Hammer Plunger
- 37 Hammer Spring
- 38 Inner Magazine Tube
- 39 Locking Bar
- 40 Locking Bar Retaining Screw
- 41 Locking Bar Spring
- 42 Locking Bar Spring Stud
- 43 Magazine Follower
- 44 Magazine Pin

VIEW# PART NAME

NOTE: Parts Subject To Change Without Notice FOB Iliion, New York.

- 45 Magazine Plug
- 46 Magazine Ring
- 47 Magazine Screw
- 48 Magazine Spring
- 49 Outer Magazine Tube
- 50 Rear Sight Aperture
- 51 Rear Sight Base
- 52 Rear Sight Base Screw
- 53 Rear Sight Base Slide
- 54 Receiver (Restricted)
- 55 Receiver Bushing
- 56 Receiver Cover
- 57 Safety Mechanism
- 58 Safety Mechanism Detent Ball
- 59 Safety Mechanism Spring
- 60 Safety Mechanism Spring Retaining Pin
- 61 Sear
- 62 Sear Pin
- 63 Sear Spring
- 64 Stock Assembly
- 65 Stock Bolt
- 66 Stock Bolt Lock Washer (2)
- 67 Stock Bolt Washer
- 68 Trigger Assembly (Restricted)
- (Includes: Connector Left, Connector Right, Connector Pin and Trigger)
- 69 Trigger Pin
- 70 Trigger Plate
- 71 Trigger Plate Pin Bushing, Rear
- 72 Trigger Plate Pin Detent Spring, Front
- 73 Trigger Plate Pin Detent Spring, Rear
- 74 Trigger Plate Pin, Front
- 75 Trigger Plate Pin, Rear
- 76 Windage Screw

How to Obtain Parts and Service From Remington Arms Company, LLC

To Order Parts:

To order parts please visit Remington's web site @ www.remingtonpartsstore.com or call 1-800-243-9700. For additional information on service enhancements, upgrades, repair, additional barrels, and specialty parts visit www.remington.com.

To place an order or for additional information on service enhancements, upgrades, and additional barrels, please call us toll free consumer service number, 1-800-243-9700, Mon.-Fri., 9:00 AM-5:00 PM Eastern time.

1. Fax completed order form (from the web site) to 1-336-548-7801.
2. To order by phone without the order form call 1-800-243-9700.

Please have the following information ready before you call.

- Firearm model and serial number.
- Part description and quantity. Part descriptions can be found on the parts listing pages 26 through 29 in this manual.
- Your complete mailing address (P.O. Box and Street Address) including zip code, telephone number and e-mail address.
- Method of payment: MasterCard, Visa, Amex or Discover card number and expiration date. A quote may be made to you over the phone. (Sorry, no C.O.D.s.)

WARNING! Use only Remington parts in Remington's firearms.

NOTE: Some parts may be restricted. See parts list for details. Owner's manuals/ instruction books may be requested via our web site at: www.remington.com or by calling 1-800-243-9700.

Repair Services

1. To locate the Remington Authorized Repair Center nearest you visit our web site at www.remington.com and use our Repair Service Locator. If you need additional on-line assistance, e-mail us at info@remington.com to obtain a listing of Authorized Repair Centers. Contact the Authorized Repair Center of your choice for evaluation of your firearm and/or additional shipping instructions.
2. If your Remington Authorized Repair Center cannot provide the service or repair you require and you need further assistance, please call our toll free number 1-800-243-9700, Mon.-Fri., 9:00 AM-5:00 PM Eastern time and select the option for repairs.
3. If shipment of your firearm is required please follow the instructions below:
 - Record the serial number of your firearm before shipping.
 - Pack your firearm for safety and to prevent further damage in shipping and handling. Preferably, ship in a firearm box.
 - Remove all accessories from the firearm to prevent loss or damage.
 - Enclose a letter with the firearm detailing the model name or number of your firearm and serial number along with a full description of the problem. Be sure to include your full name and address (P.O. Box and Street Address), including zip code, daytime telephone number and e-mail address.
 - Check your government guidelines before shipping.
 - Remington is not responsible for damage or loss during shipment. You may elect to purchase insurance from your carrier.

WARNING! Do not send live or spent shells in your firearm or in the same box with the firearm. This is a violation of federal law. If you feel you must send spent shells, please send them in a separate package and include name, address (with zip code), telephone number, model and serial number of your firearm.

Firearm Owner's Record

Model: _____

Serial # _____

Date Purchased: _____

Purchased From: _____

Price Paid: _____

Remember to complete and return the Firearm Warranty Registration Card in order to obtain full benefit of your Limited Two Year Firearm Warranty.

A WORD ON THE MAINTENANCE AND CARE OF YOUR REMINGTON FIREARM

Don't Alter or Modify Your Firearm and Have it Serviced Regularly.

Your firearm has been designed to operate according to certain factory specifications. You'll jeopardize your safety and that of others around you by attempting to alter its trigger, mechanical safety or other mechanisms. Never alter or modify your firearm in any way.

Remington recommends that you have your firearm professionally serviced annually. You should also have your firearm professionally serviced after prolonged storage, or if there is ever any question pertaining to the proper functioning characteristics of your firearm.

Like any mechanical device, a firearm is subject to wear. It must be maintained and periodically serviced to assure optimum safety and performance. Only a qualified service facility should service, repair or modify your Remington firearm. Consult your instruction manual for location of the nearest Authorized Remington Repair Center.

Proper cleaning and lubrication are also important to firearm maintenance and are necessary to assure accuracy, safety, and reliability. Before cleaning, always make sure that your firearm is completely unloaded. And always clean the barrel from the chamber end to the muzzle when possible.

Firearm Sale or Transfer:

If your firearm has been adjusted or changed in any way and you intend to sell or otherwise transfer possession of your firearm, you must: 1) provide a complete service record, (2) warn the purchaser or recipient of your firearm that it has been adjusted or modified, and (3) give the purchaser or recipient this owner's manual for review and reference. If you do not wish to sell or transfer your firearm in an adjusted condition (recommended), return it to a Remington Authorized Repair Center for restoration of your firearm to the original factory conditions. Do Not attempt to restore the firearm to factory conditions yourself.

WARNING! NEVER alter or modify any part of the firearm. Improper alterations can make the firearm unsafe and result in personal injury or death to you or others.

This firearm should not be sold where prohibited by federal, state or local laws.

Remington®

REMINGTON IS A TRADEMARK REGISTERED IN THE UNITED STATES PATENT
AND TRADEMARK OFFICE BY REMINGTON ARMS COMPANY, LLC

PRINTED IN U.S.A.

PART NO. 3530
FORM RD 7074 REV. 0312